

Design Manual V-Belt **JIS**

Classical V-Belts for JIS
Maxstar Wedge V-Belts for RMA / MPTA
Narrow V-Belts for DIN

MITSUBOSHI

®

Technical attentive consideration to both humanity and nature.



Belt Application Designing Program can be downloaded at:
https://www.mitsuboshi.co.jp/english/sien/sien_dl.html

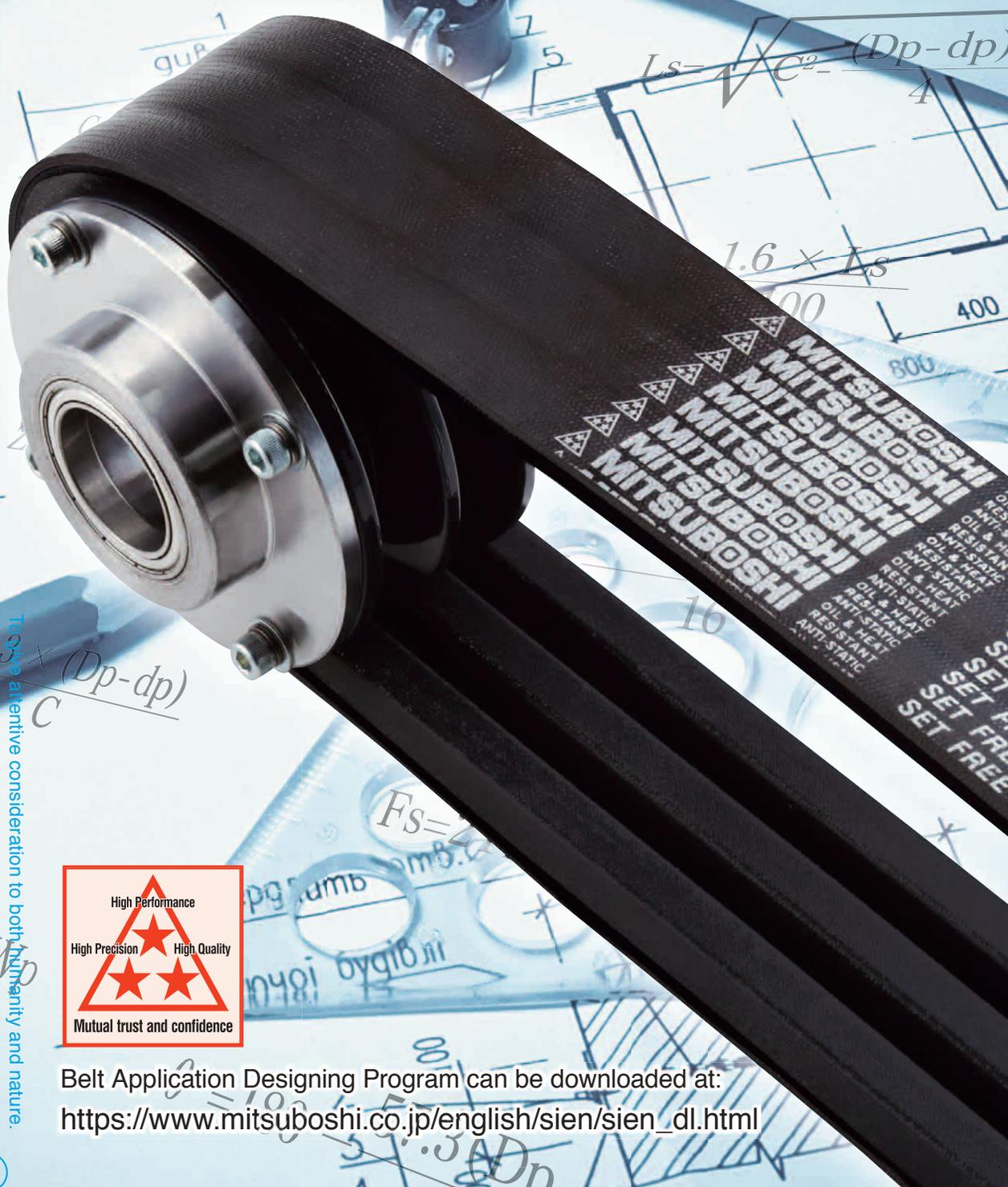

Safety Precautions

Please read all the warnings!

- Please take all necessary precautions when using our products. Also, please review relevant product catalog and design documents, etc.
Significances of safety precautions are categorized as follows:

Signs	Meanings
 Danger	Imminently causing death or severe injury to the user who misuses products.
 Warning	Possibly causing death or severe injury to the user who misuses products.
 Caution	Possibly causing personal injury or property damage if misused.

Power Transmission Products

Use	
 Danger	<ul style="list-style-type: none"> ● If you expect that a belt will fail and idle, free-run, or stop the system, thus causing a fatal or severe accident, please provide an extra safety device. ● Do not use a belt as a lifting or towing tool.
 Warning	<ul style="list-style-type: none"> ● If you expect that static electricity will come from the power transmission belt system, thus causing fire or malfunction of the controller, use an antistatic belt and set a neutralization apparatus in the system.
 Caution	<ul style="list-style-type: none"> ● Do not use a belt as an insulator. Contact us for information on insulation properties, which vary in belt type. ● For a belt that touches food directly, use one that complies with the applicable food hygiene law of your country. ● Do not modify a belt, or its quality and performance could deteriorate.

Function & Performance	
 Caution	<ul style="list-style-type: none"> ● Do not use a belt beyond its capacity or for an application other than that specified by the catalog, design documents, etc. This can cause premature failure of the belt. ● If water, oil, chemical, paint, dust, etc. sticks to a belt or pulley, its power transmission could deteriorate and the belt may fail. ● A clogged belt makes louder noise during high-speed rotation. If this occurs, use a soundproof cover.

Storage & Transportation	
 Warning	<ul style="list-style-type: none"> ● To store a heavy belt, use a suitable jig or stopper to prevent accidents such as belt toppling or tumbling.
 Caution	<ul style="list-style-type: none"> ● Use suitable equipment to carry/handle a heavy belt or pulley. Otherwise, back injury may result. ● Do not put weight on or bend a belt forcibly to carry or store it. Otherwise, it will produce defects or scratches to the belt, resulting in damage. ● Store the belt in low humidity and a temperature range of -10°C to 40°C. Do not expose belts to direct sunlight.

Mounting & Operation	
 Danger	<ul style="list-style-type: none"> ● Install a safety cover over rotating components including belt/ pulley. Otherwise, hair, gloves and clothing can become entangled in the belt/ pulley. If a belt/pulley breaks, fragments may cause injuries. ● Take the following precautions to maintain, inspect and replace a belt. <ol style="list-style-type: none"> 1) Turn off power and wait until the belt and pulley have stopped completely. 2) Secure machinery so that it may not move during belt removal. 3) Use caution : Do not unintentionally turn on power.
 Caution	<ul style="list-style-type: none"> ● Use the same type of belts or pulleys per OEM specification. Use of a different type may cause premature failure. ● Misalignment of the pulleys can damage the belt and result in flange failure. Make proper adjustments to system. ● Loosen the belt tension when changing belts. Do not force or stretch a belt over the flange. Do not use a screw driver or other sharp objects into when replacing the belt as this will result in damage. ● Apply the appropriate belt tension as specified by the relevant catalog and design documents, etc. Inappropriate tension could result in damage of the belt and shaft. ● Take the following precautions to modify the pulley in use: <ol style="list-style-type: none"> 1) Remove burrs and maintain proper pulley angle; 2) Secure accurate dimensions after modification; 3) Maintain the pulley strength after modification. ● Before assembling the flange with the pulley, check for foreign materials between the pulley and flange. Fasten the flange with a caulking tool and so on. Inappropriate installation could result in the flange coming off.

Handling of Used items	
 Caution	<ul style="list-style-type: none"> ● Do not burn belt, or hazardous gas could be produced.



CONTENTS

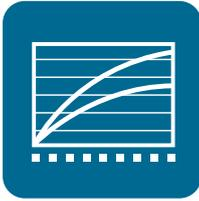

1. Properties

1. Belt Construction	P1-3
2. Product Classification	P1-4~P1-5
Classical V-Belts for JIS K 6323 / ISO4184	
Maxstar Wedge V-Belts for RMA / MPTA	
Narrow V-Belts for DIN 7753 / ISO4184	
Multi V-Belts	
Double V-Belts	
Perforated Open-End V-Belts	
3. Standard Belt Sizes	P1-6~P1-15
Classical V-Belts for JIS K 6323 / ISO4184, sections M, A, B, C, D, E, ZX, AX, BX, CX	P1-6~P1-9
Cross section Dimension for Classical V-Belts for JIS	P1-10
Maxstar Wedge V-Belts for RMA / MPTA, sections 3V, 5V, 8V, 3VX, 5VX	P1-11
Narrow V-Belts for DIN 7753 / ISO4184, sections SPZ, SPA, SPB, SPC, SPZX, SPAX, SPBX, SPCX	P1-12
Cross section Dimension for Narrow V-Belts for DIN & Maxstar Wedge V-Belts for RMA / MPTA	P1-13
Double V-Belts for DIN 7722 / ISO5289, sections AA(HAA), BB(HBB), CC(HCC)	P1-14
Perforated Open-End V-Belts	P1-15
4. Standard Pulley Sizes	P1-17~P1-19
Pulley for Classical V-Belts for JIS	P1-17
Pulley for Maxstar Wedge V-Belts for RMA / MPTA	P1-18
Pulley for Narrow V-Belts for DIN	P1-19

1
Properties

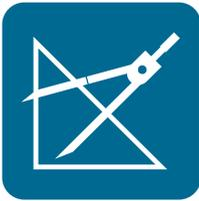
2. Design

Design process for Classical V-Belts / Narrow V-Belts	P2-3~P2-8
Calculation example for Classical V-Belts / Narrow V-Belts	P2-9
Design process for Maxstar Wedge V-Belts	P2-10~P2-15
Calculation example for Maxstar Wedge V-Belts	P2-16~P2-18
Formulas for V-Belt drive design	P2-19~P2-20
Power Rating Table	P2-21~P2-41
Drive Selection Table	P2-43~P2-62

2
Design





3. Reference

Length measurement	P3-3~P3-4
Tensioning	P3-5~P3-7
Use of idlers	P3-8
Quarter-Turn Drives	P3-9
V-Flat pulley drives	P3-10
Multi V-Belts	P3-11~P3-12
Storage and Handling of V-Belts	P3-13~P3-14
Request for belt design	P3-15
Global Factories & Sales Offices	P3-16

3
Reference

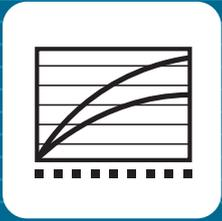

1 Properties





1. Properties

Belt Construction

Product Classification

Standard Range

V-Belt pulleys

Belt construction

■ Wrapped V-Belts

"Wrapped" means that the V-Belt core is protected by cover fabric made of cotton or polyester.

The cover fabric is coated with rubber to reinforce the wear resistance.

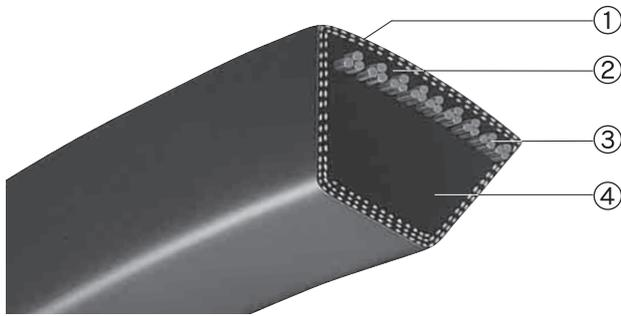

- ① Cover fabric
- ② Adhesion rubber
- ③ Cord
- ④ Compression rubber

Fig. 1-1

1
Properties



■ Raw Edge V-Belts

Raw Edge V-Belts have no fabric on the belt sides.

The special rubber compound ensures greater wear resistance than Wrapped V-Belts.

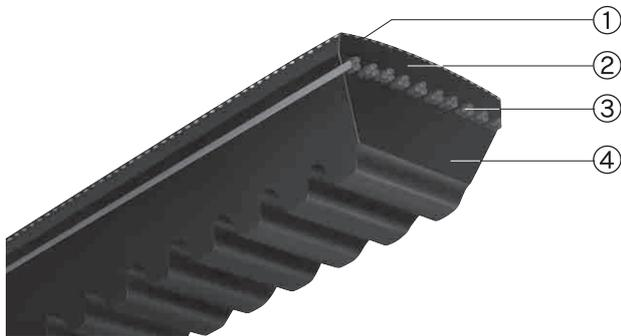

- ① Top fabric
- ② Adhesion rubber
- ③ Cord
- ④ Compression rubber

Fig. 1-2

Product Classification

■ Classical V-Belts for JIS K 6323

Classical V-Belts are most widely used power transmission belts. Economical and easily obtained for replacement.



Fig. 1-3

Sections

Wrapped type : M / A / B / C / D / E

Raw Edge type : ZX / AX / BX / CX

Working temperature

Wrapped type : -40 ~ +70°C

Raw Edge type : -30 ~ +90°C

Electrical conductivity

Suitable for ISO 1813

■ Maxstar Wedge V-Belts for RMA / MPTA

Maxstar Wedge V-Belts have double power transmission capacity of classical V-Belts due to greater wedge effect. It features high speed transmission, energy saving, and compact design.

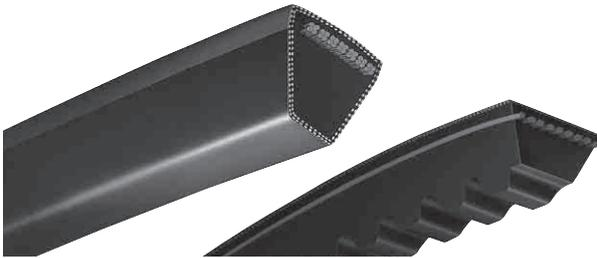

Fig. 1-4

Sections

Wrapped type : 3V / 5V / 8V

Raw Edge type : 3VX / 5VX

Working temperature

-30 ~ +90°C

Electrical conductivity

Suitable for RMA IP-3-3

■ Narrow V-Belts for DIN 7753 / ISO 4184

Narrow V-Belts enable space saving, high speed drive, and reduce the cost of operating and maintenance.

It features oil / heat resistance and electrical conductivity.

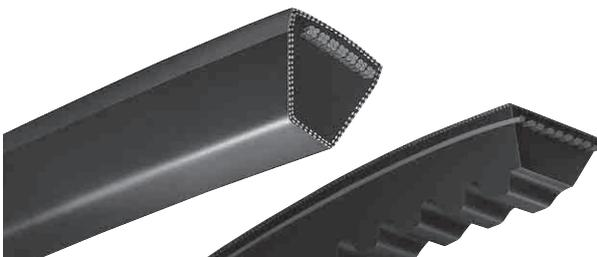

Fig. 1-5

Sections

Wrapped type : SPZ / SPA / SPB / SPC

Raw Edge type : SPZX / SPAX / SPBX / SPCX

Working temperature

-30 ~ +90°C

Electrical conductivity

Suitable for ISO 1813

1

Properties



Multi V-Belts

Multi V-Belts are made up of two or more standard V-Belts connected together at the top of the belts. Multi V-Belts have the advantage of preventing the belts from turning over or getting thrown off the drive even when belt vibration occurs.

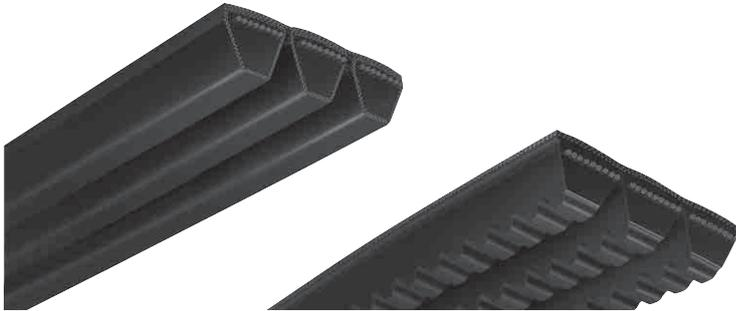

Fig. 1-6

Sections

Wrapped type : B / C / D
3V / 5V / 8V
SPB / SPC
Raw Edge type : BX / CX
3VX / 5VX

1

Properties



Double V-Belts

Double V-Belts are recommended for serpentine drives where the power must be transmitted by both the top and the bottom of the belts. Excellent flexibility in both directions.



Fig. 1-7

Sections

AA / BB / CC

Perforated open-end V-Belts

Perforated open-end V-Belts are designed for easy installation with metal fasteners and a screwdriver.

These belts are recommended for temporary use or when installation of the standard V-Belts is difficult.

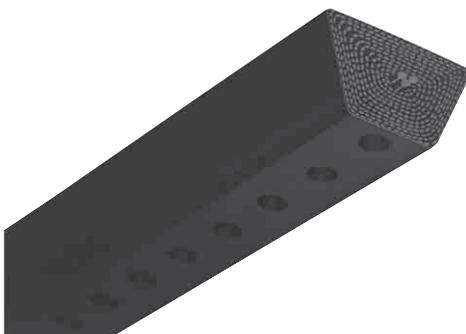

Fig. 1-8

Sections

M / A / B / C

Classical V-Belts for JIS K 6323

Table 1-1

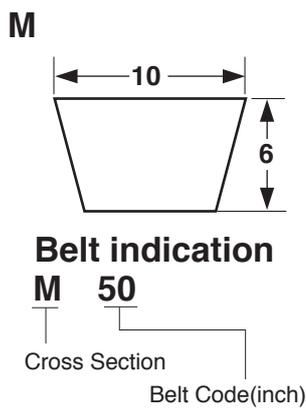

A/13, AX

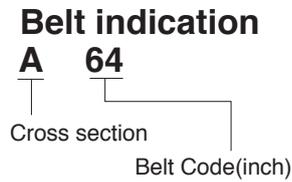
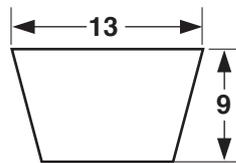

M-Section		A-Section					
Belt Code	Effective length Le (mm)	Belt Code	Pitch length Lp (mm)	Belt Code	Pitch length Lp (mm)	Belt Code	Pitch length Lp (mm)
20	508	20	508	60	1524	100	2540
21	533	21	533	61	1549	102	2591
22	559	22	559	62	1575	105	2667
23	584	23	584	63	1600	108	2743
24	610	24	610	64	1626	110	2794
25	635	25	635	65	1651	112	2845
26	660	26	660	66	1676	115	2921
27	686	27	686	67	1702	118	2997
28	711	28	711	68	1727	120	3048
29	737	29	737	69	1753	122	3099
30	762	30	762	70	1778	125	3175
31	787	31	787	71	1803	128	3251
32	813	32	813	72	1829	130	3302
33	838	33	838	73	1854	135	3429
34	864	34	864	74	1880	140	3556
35	889	35	889	75	1905	145	3683
36	914	36	914	76	1930	150	3810
37	940	37	940	77	1956	155	3937
38	965	38	965	78	1981	160	4064
39	991	39	991	79	2007	165	4191
40	1016	40	1016	80	2032	170	4318
41	1041	41	1041	81	2057	180	4572
42	1067	42	1067	82	2083		
43	1092	43	1092	83	2108		
44	1118	44	1118	84	2134		
45	1143	45	1143	85	2159		
46	1168	46	1168	86	2184		
47	1194	47	1194	87	2210		
48	1219	48	1219	88	2235		
49	1245	49	1245	89	2261		
50	1270	50	1270	90	2286		
		51	1295	91	2311		
		52	1321	92	2337		
		53	1346	93	2362		
		54	1372	94	2388		
		55	1397	95	2413		
		56	1422	96	2438		
		57	1448	97	2464		
		58	1473	98	2489		
		59	1499	99	2515		

Size range: 20" ~ 93"

Size range: 20" ~ 360"

 : Available size for Raw Edge Cogged V-Belts AX

1

Properties

Classical V-Belts for JIS K 6323

Table 1-2

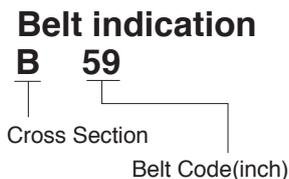
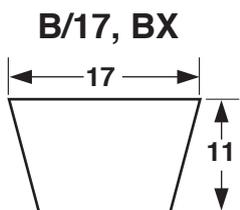

B-Section

Belt Code	Pitch length Lp (mm)	Belt Code	Pitch length Lp (mm)	Belt Code	Pitch length Lp (mm)
25	635	65	1651	112	2845
26	660	66	1676	115	2921
27	686	67	1702	118	2997
28	711	68	1727	120	3048
29	737	69	1753	122	3099
30	762	70	1778	125	3175
31	787	71	1803	128	3251
32	813	72	1829	130	3302
33	838	73	1854	132	3353
34	864	74	1880	135	3429
35	889	75	1905	138	3505
36	914	76	1930	140	3556
37	940	77	1956	145	3683
38	965	78	1981	150	3810
39	991	79	2007	155	3937
40	1016	80	2032	160	4064
41	1041	81	2057	165	4191
42	1067	82	2083	170	4318
43	1092	83	2108	180	4572
44	1118	84	2134	190	4826
45	1143	85	2159	200	5080
46	1168	86	2184	210	5334
47	1194	87	2210		
48	1219	88	2235		
49	1245	89	2261		
50	1270	90	2286		
51	1295	91	2311		
52	1321	92	2337		
53	1346	93	2362		
54	1372	94	2388		
55	1397	95	2413		
56	1422	96	2438		
57	1448	97	2464		
58	1473	98	2489		
59	1499	99	2515		
60	1524	100	2540		
61	1549	102	2591		
62	1575	105	2667		
63	1600	108	2743		
64	1626	110	2794		

Size range: 23" ~ 660"

: Available size for Raw Edge Cogged V-Belts BX

1
Properties



Classical V-Belts for JIS K 6323

Table 1-3

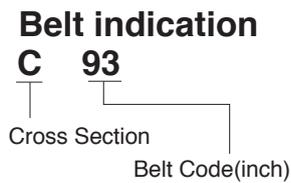
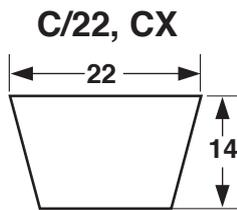

C-Section

Belt Code	Pitch length Lp (mm)	Belt Code	Pitch length Lp (mm)	Belt Code	Pitch length Lp (mm)
40	1016	86	2184	190	4826
42	1067	87	2210	200	5080
45	1143	88	2235	210	5334
48	1219	89	2261	220	5588
50	1270	90	2286	230	5842
51	1295	91	2311	240	6096
52	1321	92	2337	250	6350
53	1346	93	2362	260	6604
54	1372	94	2388	270	6858
55	1397	95	2413		
56	1422	96	2438		
57	1448	97	2464		
58	1473	98	2489		
59	1499	99	2515		
60	1524	100	2540		
61	1549	102	2591		
62	1575	105	2667		
63	1600	108	2743		
64	1626	110	2794		
65	1651	112	2845		
66	1676	115	2921		
67	1702	118	2997		
68	1727	120	3048		
69	1753	122	3099		
70	1778	125	3175		
71	1803	128	3251		
72	1829	130	3302		
73	1854	132	3353		
74	1880	135	3429		
75	1905	138	3505		
76	1930	140	3556		
77	1956	142	3607		
78	1981	145	3683		
79	2007	148	3759		
80	2032	150	3810		
81	2057	155	3937		
82	2083	160	4064		
83	2108	165	4191		
84	2134	170	4318		
85	2159	180	4572		

Size range: 37" ~ 660"

: Available size for Raw Edge Cogged V-Belts CX

1

Properties



Classical V-Belts for JIS K 6323

Table 1-4

D/32

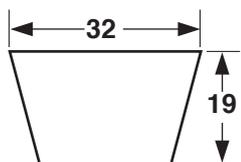

Belt indication

D 120

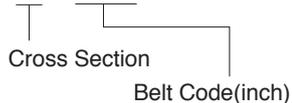

E/40

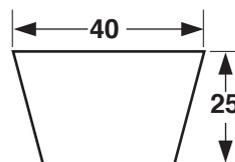

Belt indication

E 180

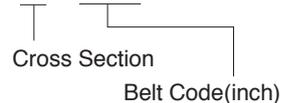

D-Section

E-Section

Belt Code	Pitch length Lp (mm)	Belt Code	Pitch length Lp (mm)
100	2540	180	4572
105	2667	210	5334
110	2794	240	6096
115	2921	270	6858
120	3048	300	7620
125	3175	330	8382
130	3302	360	9144
135	3429	390	9906
140	3556	420	10668
145	3683		
150	3810		
155	3937		
160	4064		
165	4191		
170	4318		
180	4572		
190	4826		
200	5080		
210	5334		
220	5588		
230	5842		
240	6096		
250	6350		
260	6604		
270	6858		
280	7112		
300	7620		
310	7874		
330	8382		
360	9144		

Size range: 144" ~ 660"

Size range: 100" ~ 660"

1
Properties



Cross section Dimension of Classical V-Belts for JIS

Table 1-5

Section		M	A	B	C	D	E
Top belt width	b_o (mm)	10	13	17	22	32	40
Pitch width	b_p (mm)	8.0	9.2	12.5	16.9	24.6	28.7
Height of belt	h (mm)	6	9	11	14	19	25
Distance down to pitch line	h_p (mm)	2.7	4.5	5.5	7	9.5	12.7
Allowed minimum Pulley pitch diameter	d_p (mm)	40	67 (63)	118 (90)	180 (140)	300	450
Recommended maximum Belt speed	V (m/s)	30					

() : Figure of allowed minimum Pulley pitch diameter for Raw Edge Cogged type.

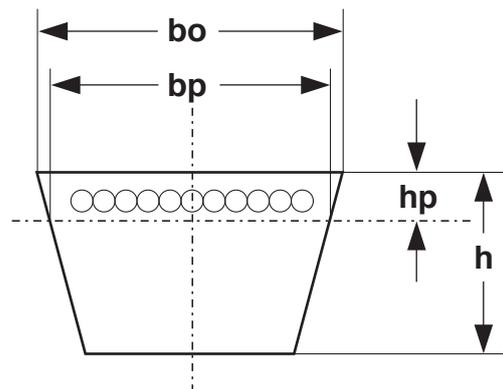
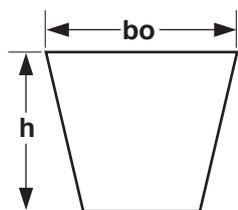

Fig. 1-9



Maxstar Wedge V-Belts for RMA / MPTA



Section	bo (mm)	h (mm)
3V/9N	9.5	8.0
5V/15N	16.0	13.5
8V/25N	25.5	23.0

Belt type	3VX		5VX	
Belt length range(inch)	25~95	96~270	25~95	96~270
bo(mm)	9.9	8.6	16.6	15.7
h(mm)	8.7	9.0	13.5	13.7

Belt indication

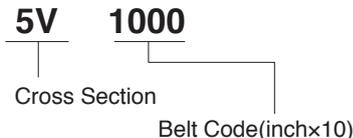

Table 1-6

3V(3VX)-Section		5V(5VX)-Section		8V-Section	
Belt Code	Effective length Le (mm)	Belt Code	Effective length Le (mm)	Belt Code	Effective length Le (mm)
250	635	500	1270	1000	2540
265	673	530	1346	1060	2692
280	711	560	1422	1120	2845
300	762	600	1524	1180	2997
315	800	630	1600	1250	3175
335	851	670	1702	1320	3353
355	902	710	1803	1400	3556
375	953	750	1905	1500	3810
400	1016	800	2032	1600	4064
425	1080	850	2159	1700	4318
450	1143	900	2286	1800	4572
475	1207	950	2413	1900	4826
500	1270	1000	2540	2000	5080
530	1346	1060	2692	2120	5385
560	1422	1120	2845	2240	5690
600	1524	1180	2997	2360	5994
630	1600	1250	3175	2630	5994
670	1702	1320	3353	2500	6350
710	1803	1400	3556	2650	6731
750	1905	1500	3810	2800	7112
800	2032	1600	4064	3000	7620
850	2159	1700	4318	3150	8001
900	2286	1800	4572	3350	8509
950	2413	1900	4826	3550	9017
1000	2540	2000	5080	3750	9525
1060	2692	2120	5385	4000	10160
1120	2845	2240	5690	4250	10795
1180	2997	2360	5994	4500	11430
1250	3175	2500	6350	4750	12065
1320	3353	2650	6731	5000	12700
1400	3556	2800	7112	5600	14224
		3000	7620	6000	15240
		3150	8001		
		3350	8509		
		3550	9017		

: Available size for Raw Edge Cogged V-Belts 3VX & 5VX

1

Properties

Narrow V-Belts for DIN7753 / ISO4184

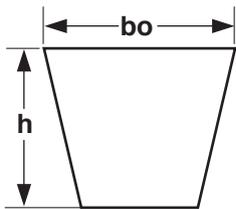

Section	bo (mm)	h (mm)
SPZ (SPZX)	9.7	8.0
SPA (SPAX)	12.7	10.0
SPB (SPBX)	16.3	13.0
SPC (SPCX)	22.0	18.0

Belt indication

SPZ 1000

Cross Section

Datum length(mm)

Table 1-7

SPZ(SPZX)-Section				SPA(SPAX)-Section				SPB(SPBX)-Section				SPC(SPCX)-Section	
Datum length Ld(mm)	Outer length La(mm)	Datum length Ld(mm)	Outer length La(mm)	Datum length Ld(mm)	Outer length La(mm)	Datum length Ld(mm)	Outer length La(mm)	Datum length Ld(mm)	Outer length La(mm)	Datum length Ld(mm)	Outer length La(mm)	Datum length Ld(mm)	Outer length La(mm)
487	500	1520	1533	732	750	2132	2150	1250	1272	4620	4642	2000	2030
512	525	1537	1550	742	760	2182	2200	1320	1342	4720	4742	2120	2150
562	575	1562	1575	757	775	2232	2250	1340	1362	4750	4772	2360	2390
587	600	1587	1600	782	800	2240	2258	1400	1422	4820	4842	2500	2530
612	625	1600	1613	800	818	2307	2325	1410	1432	4870	4892	3100	3130
630	643	1612	1625	807	825	2360	2378	1500	1522	5000	5022	3150	3180
637	650	1637	1650	832	850	2432	2450	1510	1532	5070	5092	3200	3230
662	675	1662	1675	850	868	2482	2500	1590	1612	5300	5322	3220	3250
670	683	1687	1700	857	875	2500	2518	1600	1622	5380	5402	3320	3350
687	700	1700	1713	882	900	2607	2625	1690	1712	5500	5522	3350	3380
710	723	1737	1750	900	918	2650	2668	1700	1722	5600	5622	3375	3405
722	735	1762	1775	907	925	2800	2818	1750	1772	5680	5702	3420	3450
737	750	1787	1800	932	950	3000	3018	1800	1822	5800	5822	3430	3460
750	763	1800	1813	950	968	3082	3100	1850	1872	5990	6012	3450	3480
760	773	1812	1825	957	975	3132	3150	1900	1922	6000	6022	3500	3530
762	775	1837	1850	967	985	3150	3168	1950	1972	6300	6322	3520	3550
772	785	1862	1875	982	1000	3182	3200	2000	2022	6340	6362	3550	3580
787	800	1887	1900	1000	1018	3282	3300	2030	2052	6700	6722	3600	3630
800	813	1900	1913	1032	1050	3350	3368	2060	2082	6720	6742	3620	3650
812	825	1937	1950	1057	1075	3382	3400	2120	2142	7100	7122	3670	3700
825	838	1987	2000	1082	1100	3482	3500	2150	2172	7500	7522	3700	3730
837	850	2000	2013	1107	1125	3500	3518	2180	2202	8000	8022	3750	3780
850	863	2030	2043	1120	1138	3550	3568	2240	2262	8500	8522	3770	3800
862	875	2037	2050	1132	1150	3650	3668	2280	2302	9000	9022	3800	3830
875	888	2087	2100	1157	1175	3750	3768	2310	2332			3810	3840
887	900	2120	2133	1182	1200	3870	3888	2360	2382			3970	4000
900	913	2137	2150	1207	1225	4000	4018	2410	2432			4000	4030
912	925	2160	2173	1232	1250	4120	4138	2425	2447			4050	4080
925	938	2187	2200	1250	1268	4250	4268	2450	2522			4100	4130
937	950	2200	2213	1257	1275	4300	4318	2530	2552			4200	4230
950	963	2240	2253	1272	1290	4500	4518	2650	2672			4250	4280
962	975	2280	2293	1282	1300	4600	4618	2680	2702			4300	4330
987	1000	2337	2350	1300	1318	4750	4768	2800	2822			4350	4380
1000	1013	2410	2423	1307	1325	4865	4883	2840	2862			4380	4410
1010	1023	2500	2513	1320	1338	5000	5018	3000	3022			4400	4430
1012	1025	2540	2553	1332	1350			3070	3092			4420	4450
1024	1037	2650	2663	1357	1375			3150	3172			4445	4475
1037	1050	2690	2703	1367	1385			3170	3192			4450	4480
1047	1060	2840	2853	1382	1400			3175	3197			4500	4530
1060	1073	3070	3083	1400	1413			3200	3222			4530	4560
1077	1090	3150	3163	1407	1425			3238	3260			4650	4680
1080	1093	3170	3183	1432	1450			3250	3272			4720	4750
1087	1100	3200	3213	1457	1475			3280	3302			4750	4780
1100	1113	3250	3263	1482	1500			3328	3350			4850	4880
1112	1125	3350	3363	1500	1518			3340	3362			4900	4930
1120	1133	3450	3463	1507	1525			3350	3372			4970	5000
1137	1150	3550	3563	1532	1550			3400	3422			5000	5030
1140	1153	3660	3673	1557	1575			3412	3434			5030	5060
1162	1175	3750	3763	1582	1600			3425	3447			5070	5100
1180	1193	4000	4013	1600	1618			3450	3472			5200	5230
1187	1200	4500	4513	1607	1625			3500	3522			5300	5330
1200	1213			1632	1650			3550	3572			5330	5360
1202	1215			1657	1675			3650	3672			5400	5430
1212	1225			1682	1700			3675	3697			5500	5530
1237	1250			1700	1718			3700	3722			5600	5630
1250	1263			1707	1725			3750	3772			5700	5730
1262	1275			1732	1750			3770	3792			6000	6030
1270	1283			1757	1775			3800	3822			6200	6230
1287	1300			1782	1800			3850	3872			6300	6330
1300	1313			1800	1818			3870	3892			6480	6510
1312	1325			1807	1825			3875	3897			6500	6530
1320	1333			1832	1850			4000	4022			6700	6730
1337	1350			1857	1875			4060	4082				
1340	1353			1882	1900			4100	4122				
1362	1375			1900	1918			4120	4142				
1387	1400			1907	1925			4250	4272				
1400	1413			1932	1950			4260	4282				
1412	1425			1957	1975			4296	4318				
1420	1433			1982	2000			4310	4332				
1437	1450			2000	2018			4318	4340				
1462	1475			2032	2050			4370	4392				
1487	1500			2057	2075			4500	4522				
1500	1513			2082	2100			4560	4582				
1512	1525			2120	2138			4600	4622				

up to 10000

up to 10000

: Available size for Narrow Raw Edge Cogged V-Belts SPZX, SPAX, SPBX, SPCX

1
Properties

Cross section dimension of Narrow V-Belts for DIN & Maxstar Wedge V-Belts for RMA / MPTA

Table 1-8

Section		SPZ	SPA	SPB	SPC	3V	5V	8V
Top belt width	b_o (mm)	9.7	12.7	16.3	22.0	9.5	16.0	25.5
Datum width	b_d (mm)	8.5	11.0	14.0	19.0			
Height of belt	h (mm)	8.0	10.0	13.0	18.0	8.0	13.5	23.0
Inner length	$L_i \cong L_d -$ (mm)	38	45	60	83			
Outer length	$L_o \cong L_d +$ (mm)	13	18	22	30			
Distance down to datum line	h_d (mm)	2.0	2.8	3.5	4.8			
Recommended minimum Pulley datum diameter	dd (mm)	63 (56)	90 (71)	140 (112)	224 (180)	63 (56)	140 (112)	335
Recommended maximum Belt speed	V (m/s)	40						

() : Recommended minimum Pulley datum diameter for Raw Edge Cogged type.

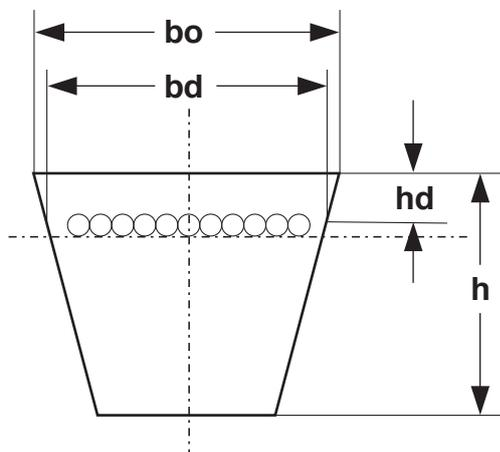

Fig. 1-10

1
Properties

Double V-Belts for DIN 7722/ISO 5289/RMA IP-21

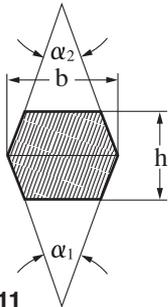

Fig. 1-11

Dimension of Double V-Belts

Table 1-9

Section	AA	BB	CC
Belt width b (mm)	12.5	15.5	22.0
Belt height h (mm)	10.0	13.0	17.0
Belt angle α_1 (°)	40	40	40
Belt angle α_2 (°)	40	40	40
Recommended minimum pulley diameter (mm)	75	130	230

AA Cross Section Table 1-10

Belt Code	Pitch length	
	inch	mm
AA 41	43.1	1095
AA 46	48.1	1222
AA 49	51.1	1298
AA 51	53.1	1349
AA 52	54.1	1374
AA 53	55.1	1400
AA 55	57.1	1450
AA 60	62.1	1577
AA 72	74.1	1882
}	}	}
AA 300	301.1	7648

BB Cross Section Table 1-11

Belt Code	Pitch length	
	inch	mm
BB 54	56.9	1445
BB 55	57.9	1471
BB 59	61.9	1572
BB 60	62.9	1598
BB 71	73.9	1877
}	}	}
BB 400	401.4	10196

CC Cross Section Table 1-12

Belt Code	Pitch length	
	inch	mm
CC 71	75.2	1910
}	}	}
CC 500	502.2	12756

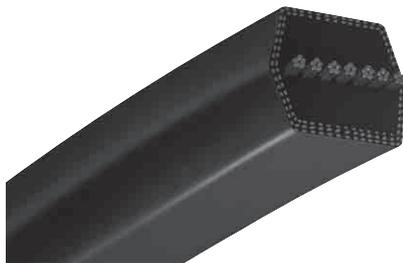

Fig. 1-12

1

Properties

Perforated Open-End V-Belts

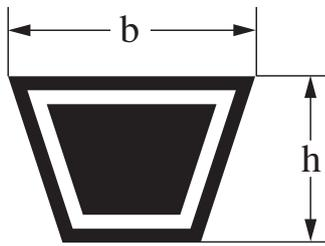

Fig. 1-13

Dimension of Perforated Open-End V-Belts

Table 1-13

Section	M	A	B	C
Belt width b (mm)	10.0	12.5	16.5	22.0
Belt height h (mm)	5.5	9.0	11.0	14.0
Belt angle ($^{\circ}$)	40	40	40	40
Length per roll (m)	100	100	100	100
Hole diameter (mm)	2.0	2.5	3.0	4.0
Hole pitch (mm)	5.0	8.0	9.0	11.0

1
Properties

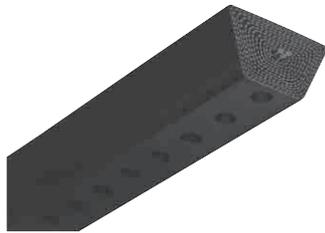

Fig. 1-14

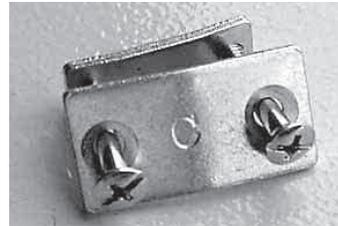

Fig. 1-15 (Metal fastener)

1

Properties



Pulley for Classical V-Belts for JIS

Pulley for Classical V-Belts complies with JIS B 1854.

Fig. 1-16

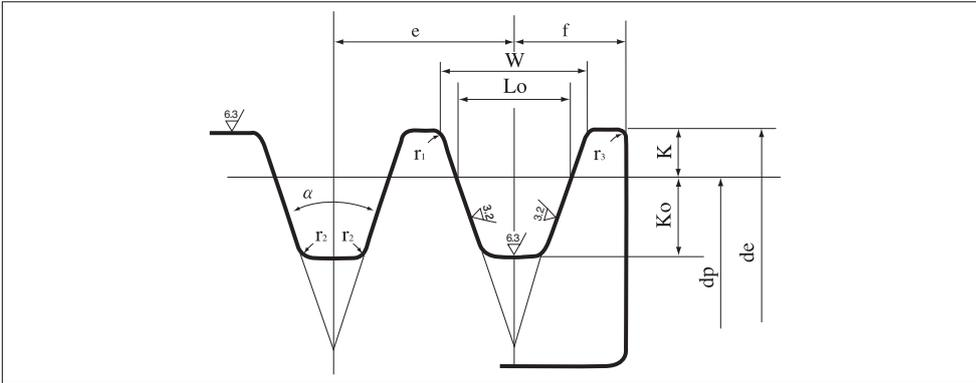

Dimensions (mm)

Table 1-14

Belt section	Pitch diameter : dp	α (°)	W	Lo	K	Ko	e	f
M	$50 \leq dp \leq 71$	34	9.65	8.0	2.7	6.3	-	9.5
	$71 < dp \leq 90$	36	9.75					
	$90 < dp$	38	9.86					
A AX	$71 \leq dp \leq 100$	34	11.95	9.2	4.5	8.0	15.0	10.0
	$100 < dp \leq 125$	36	12.12					
	$125 < dp$	38	12.30					
B BX	$125 \leq dp \leq 160$	34	15.86	12.5	5.5	9.5	19.0	12.5
	$160 < dp \leq 200$	36	16.07					
	$200 < dp$	38	16.29					
C CX	$200 \leq dp \leq 250$	34	21.18	16.9	7.0	12.0	25.5	17.0
	$250 < dp \leq 315$	36	21.45					
	$315 < dp$	38	21.72					
D	$355 \leq dp \leq 450$	36	30.77	24.6	9.5	15.5	37.0	24.0
	$450 < dp$	38	31.14					
E	$500 \leq dp \leq 630$	36	36.95	28.7	12.7	19.3	44.5	29.0
	$630 < dp$	38	37.45					

Number of belts & pulley width (mm)

Table 1-15

Number of belt	A AX	B BX	C CX	D	E
1	20	25	34	48	58
2	35	44	59	85	102
3	50	63	85	122	147
4	65	82	110	159	191
5	80	101	136	196	236
6	95	120	161	233	280
7	110	139	187	270	325
8	125	158	212	307	369
9	140	177	238	344	414
10	155	196	263	381	458
11	170	215	289	418	503
12	185	234	314	455	547
13	200	253	340	492	592
14	215	272	365	529	635
15		291	391	566	681
16		310	416	603	725
17		329	442	640	770
18			467	677	814
19			491	714	859
20			518	751	903



Pulley for Maxstar Wedge V-Belts for RMA / MPTA

Fig. 1-17

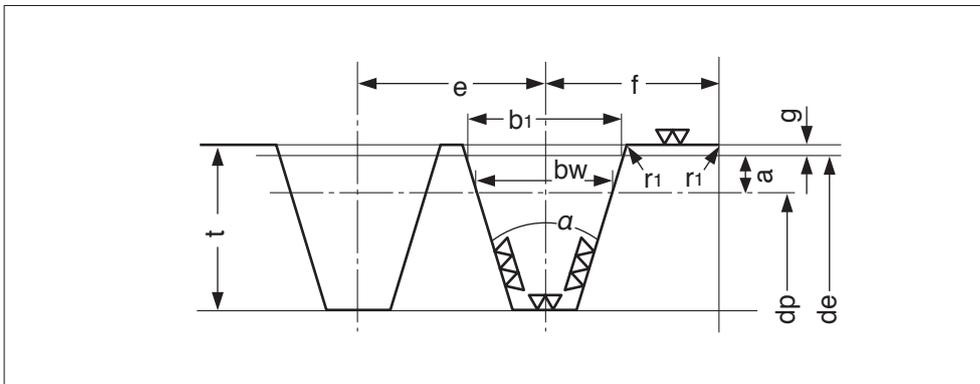

Dimensions(mm)

Table 1-16

Belt section	Effective diameter: de	α (°)	Effective width b1	Pitch width bw	a	Groove depth min. t	Pitch e	Groove spacing:f	g
3V (3VX)	≤ 90	36 ± 0.5	8.9 ± 0.13	8.51	0.6	8.9	10.3 ± 0.25	8.7	0.20
	$90 < de \leq 150$	38 ± 0.5		8.49					
	$150 < de \leq 300$	40 ± 0.5		8.46					
	> 300	42 ± 0.5		8.44					
5V (5VX)	≤ 250	38 ± 0.5	15.2 ± 0.13	14.30	1.3	15.2	17.5 ± 0.25	12.7	0.25
	$250 < de \leq 400$	40 ± 0.5		14.25					
	> 400	42 ± 0.5		14.20					
8V	≤ 400	38 ± 0.5	25.4 ± 0.13	23.68	2.5	25.4	28.6 ± 0.25	19.0	0.30
	$400 < de \leq 560$	40 ± 0.5		23.58					
	> 560	42 ± 0.5		23.48					

Number of belts & pulley width(mm)

Table 1-17

Belt Section	Number of belts	1	2	3	4	5	6	7	8	9	10
	3V		18	28	38	49	59	69	80	90	100
5V		26	43	61	78	96	113	131	148	166	183
8V		38	67	96	124	153	181	210	239	267	296

1
Properties

Pulley for Narrow V-Belts for DIN

Pulley for Narrow V-Belts complies with DIN 2217 Part 1.

Fig. 1-18

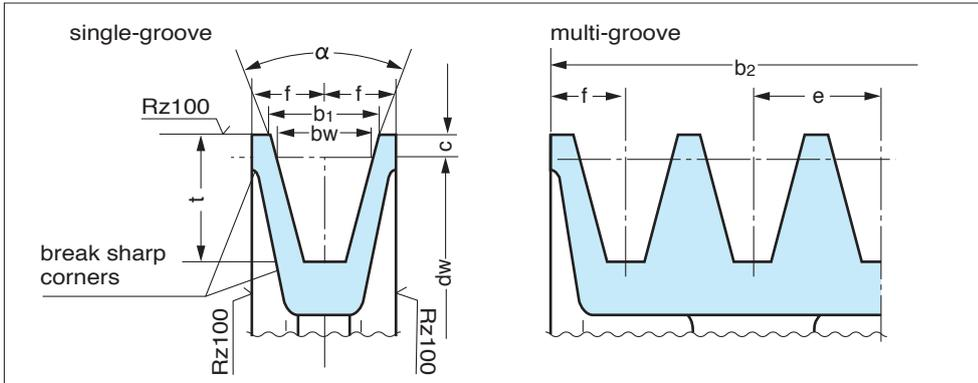

Dimensions (mm)

Table 1-18

Belt section	Datum diameter : dw	α (°)	b1	bw	c	t	e	f
SPZ SPZX	$dw \leq 80$ $80 < dw$	34 38	9.7	8.5	2.0	$11^{+0.6}_0$	12 ± 0.3	8 ± 0.6
SPA SPAX	$dw \leq 118$ $118 < dw$	34 38	12.7	11.0	2.8	$14^{+0.6}_0$	15 ± 0.3	10 ± 0.6
SPB SPBX	$dw \leq 190$ $190 < dw$	34 38	16.3	14.0	3.5	$18^{+0.6}_0$	19 ± 0.4	12.5 ± 0.8
SPC SPCX	$dw \leq 315$ $315 < dw$	34 38	22.0	19.0	4.8	$24^{+0.6}_0$	25.5 ± 0.5	17.0 ± 1.0

bw corresponds to Datum width bd

dw corresponds to Datum diameter dd

Number of belts & pulley width b2 (mm)

Table 1-19

Number of belt	SPZ SPZX	SPA SPAX	SPB SPBX	SPC SPCX
1	16	20	25	34
2	28	35	44	59.5
3	40	50	63	85
4	52	65	82	110.5
5	64	80	101	136
6	76	95	120	161.5
7	88	110	139	187
8	100	125	158	212.5
9	112	140	177	238
10	124	155	196	263.5
11	136	170	215	289
12	148	185	234	314.5



1

Properties



Design

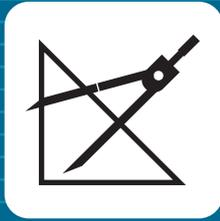

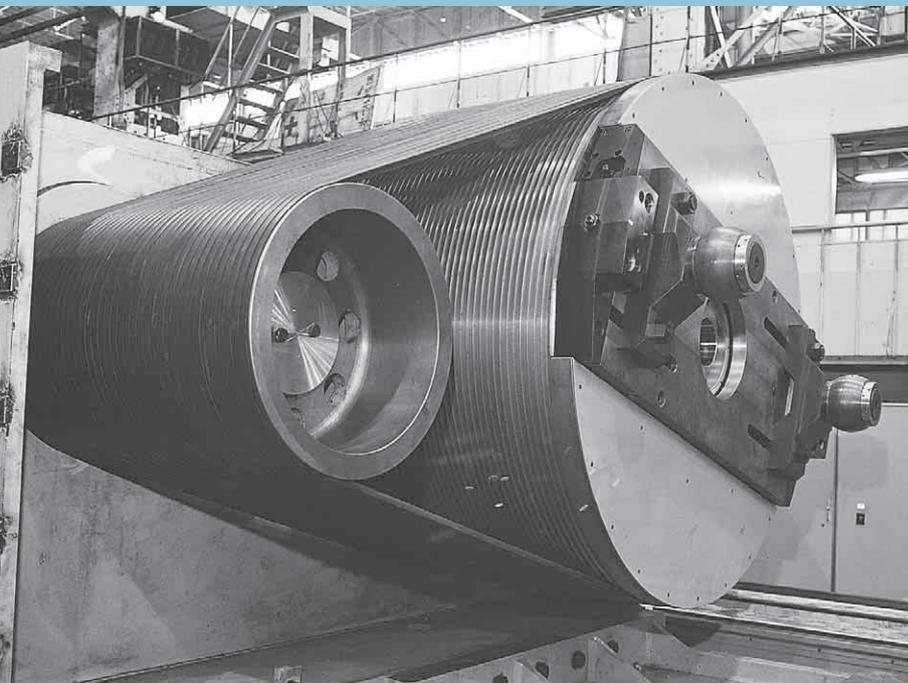

2.Design

Design process

Calculation example

Formulas for V-Belt drive design

Power Rating Table

Drive Selection Table

Design process for Classical V-Belts / Narrow V-Belts

Design Flow

1 Set conditions required in design work.

a. Type of machine

b. Transmission power

It is ideal to use the actual load applied to the belt as the value of the transmission power, but the rated power of the motor is commonly used for calculation.

c. Running hours in a single day

d. Small pulley speed

e. Speed ratio

$$\text{Speed ratio} = \frac{\text{Large pulley pitch diameter}}{\text{Small pulley pitch diameter}}$$

f. Interim center distance

g. Special uses and environmental conditions

Contact us for the case of exposure to high or low temperature, water, oil, acid or alkali.

Design Flow

2 Set the design power.

1. How to calculate the service factor (Ks)

$$K_s = K_o + K_i + K_e$$

Wherein, Ks : Service factor

Ko : Service correction factor >> (Table 2-1)

Ki : Idler correction factor >> (Table 2-2)

Ke : Environment correction factor >> (Table 2-3)

2. How to calculate the design power (Pd)

$$P_d = P_t \times K_s$$

Wherein, Pd : Design power (kW)

Pt : Transmission power (kW)

Ks : Service factor

The value of transmission power used in designing is the power requirement of the driven machine, if obtained, or the power of driving unit (engine or motor).

Convert the value from torque (Tq) or horse power (PS) into kW with the formula below.

$$P_t = \frac{T_q \times n}{9.55 \times 10^3}$$

Wherein, Pt : Transmission power (kW)

Tq : Torque (N·m)

n : Shaft speed (rpm)

$$1 \text{ PS} = 0.7355 \text{ kW}$$



1. Ko

Service correction factor (Ko)

Table 2-1

Driven Machine	Driving unit / Motor					
	Max power \leq 300% of rated power			Max power $>$ 300% of rated power		
	AC motors, single-and three-phase with star-delta start. DC shunt-wound motors, Multiple cylinder internal combustion engines.			AC motors, single and three-phase, series wound, slip-ring motors with direct start. DC motors, series and compound wound. Single cylinder internal combustion engines.		
	Running time (hrs./day)			Running time (hrs./day)		
	3 ~ 5	8 ~ 12	16 ~ 24	3 ~ 5	8 ~ 12	16 ~ 24
<ul style="list-style-type: none"> ● Agitator for liquid ● Small centrifugal blower ● Fan up to 7.5 kW ● Light-duty conveyor 	1.0	1.1	1.2	1.1	1.2	1.3
<ul style="list-style-type: none"> ● Belt conveyor (for sand, grain, etc.) ● Dough mixer ● Fan over 7.5 kW ● Generator ● Machine tool ● Punching machine ● Pressing machine ● Shearing machine ● Printing machine ● Positive displacement rotary pump ● Vibrating and rotary screen 	1.1	1.2	1.3	1.2	1.3	1.4
<ul style="list-style-type: none"> ● Brick-making machinery ● Bucket elevator ● Piston compressor ● Screw conveyor ● Hammer mill ● Hollander ● Piston pump ● Positive displacement blower ● Crusher ● Woodworking machinery ● Textile machinery 	1.2	1.3	1.4	1.4	1.5	1.6
<ul style="list-style-type: none"> ● Gyratory and jaw-roll crusher ● Mill (ball/rod) ● Hoist (heavy load) ● Rolling mill, calender etc, for the rubber and plastic industry 	1.3	1.4	1.5	1.5	1.6	1.8

2. Ki

Idler correction factor (Ki)

Table 2-2

Location of Idler	Ki
Belt slack side, inside of belt	0.0
Belt slack side, outside of belt	0.1
Belt tight side, inside of belt	0.1
Belt tight side, outside of belt	0.2

3. Ke

Environment correction factor (Ke)

Table 2-3

Environmental condition	Ke
Frequent start and stop of machine	0.2
Hard to conduct maintenance checkup	0.2
Dusty environment	0.2
High temperature	0.2
Oil or water splashing	0.2

● Avoid oil and water splash by cover to prevent belt slipping.



3

Select the belt type.

● Select the belt type in the selection charts below according to design power and small pulley speed.

● If the intersection locates near the dividing line, select belt type considering other conditions such as pulley cost.

Cross section selection chart for Classical V-Belts for RMA

Fig. 2-1

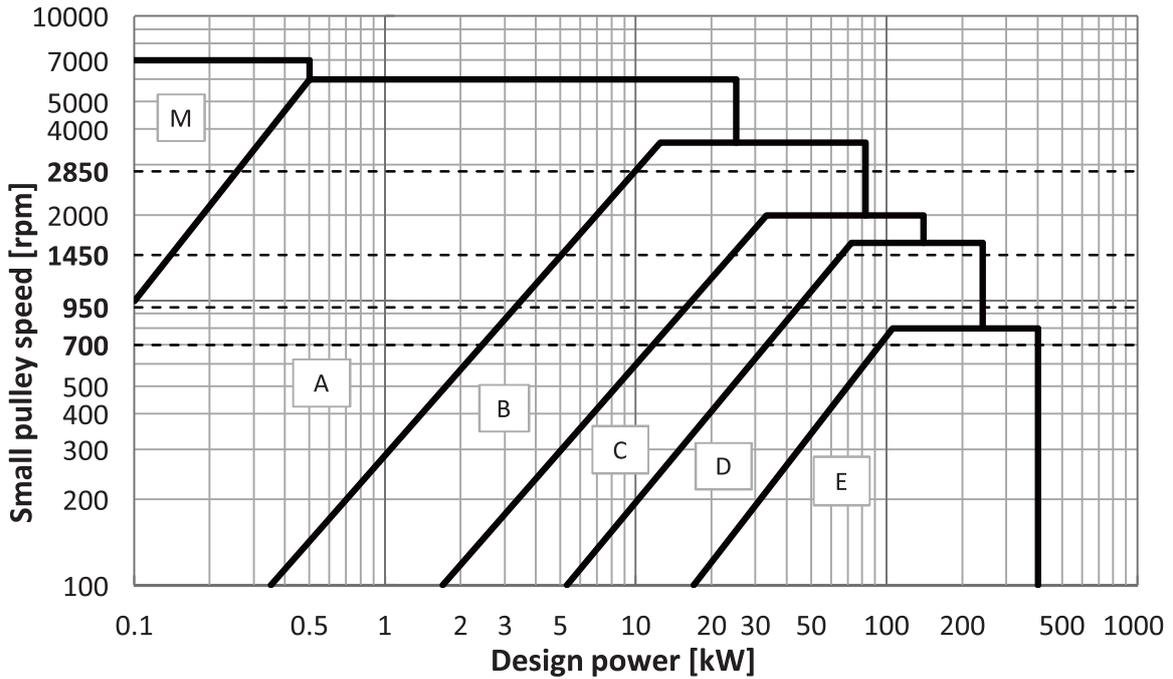

Cross section selection chart for Classical Raw Edge Cogged V-Belts

Fig. 2-2

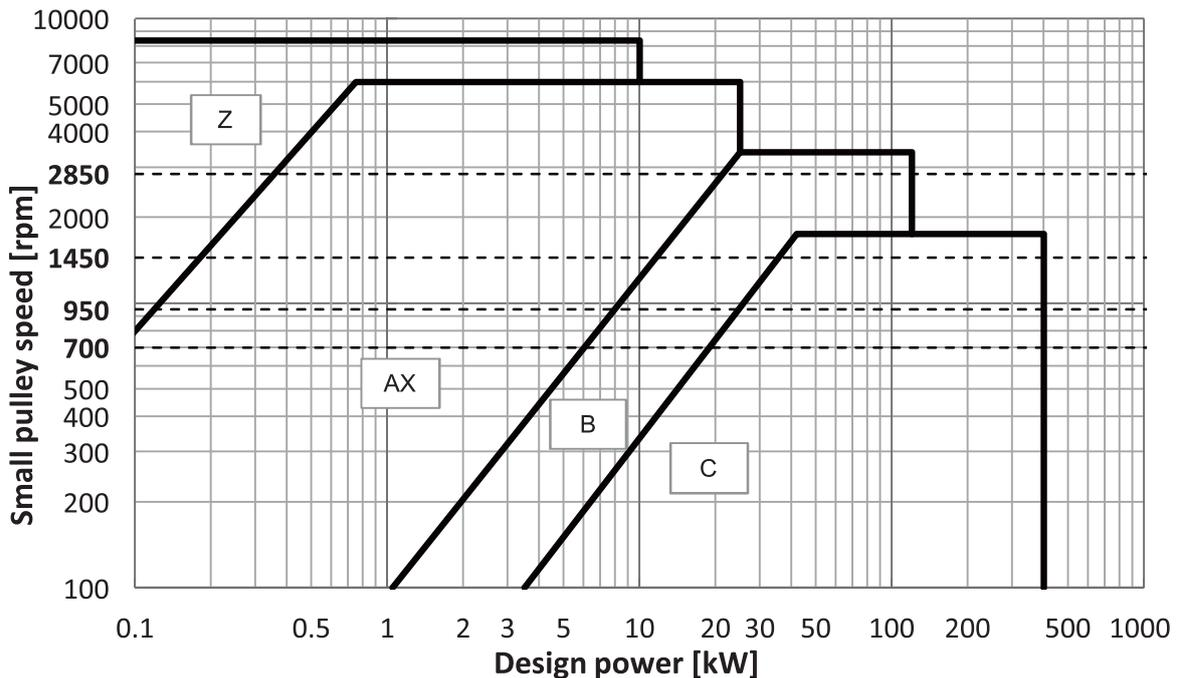

Cross section selection chart for Narrow V-Belts for DIN

Fig. 2-3

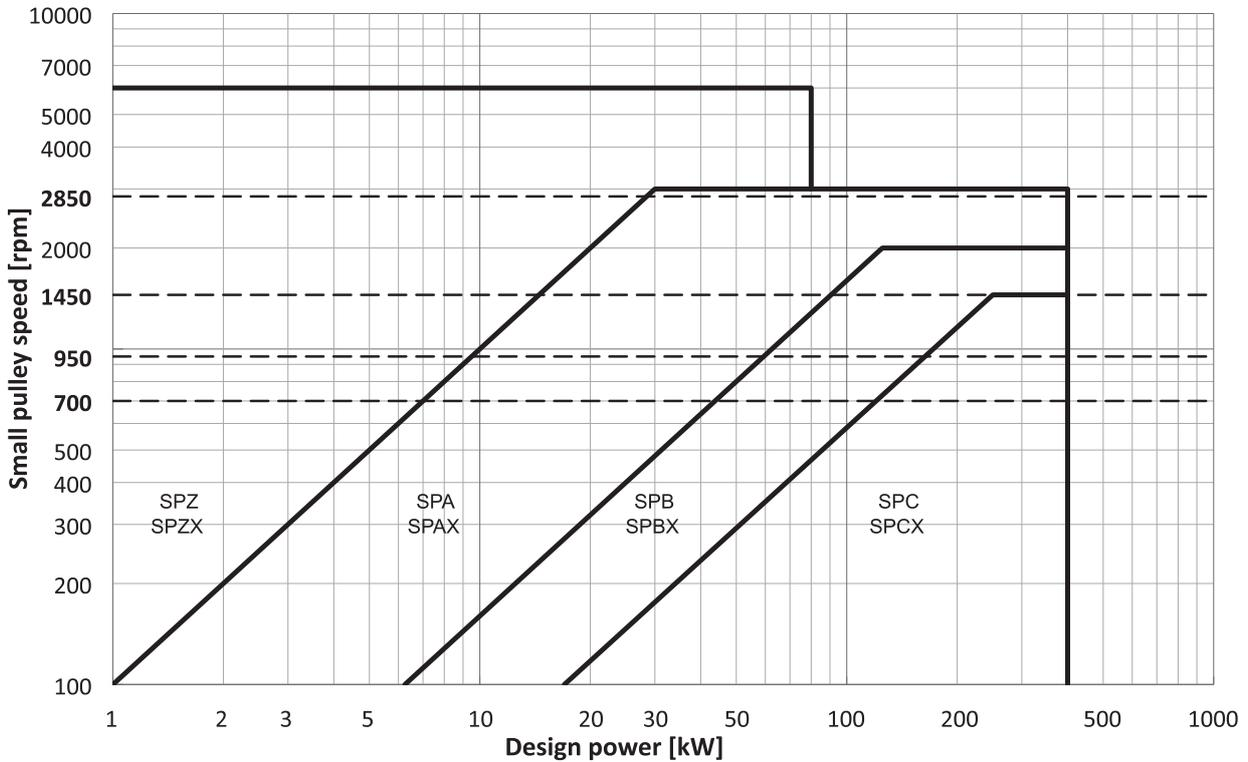

Design Flow



Select the pulley size.

- Select the small pulley pitch diameter larger than the minimum specified in the Table 2-4. Inappropriate pulley reduces transmission efficiency and belts' durability significantly.

Minimum pulley pitch diameter Unit : mm Table 2-4

Belt type	M	A	B	C	D	E
Recommended minimum pulley pitch diameter	50	95	150	224	355	560
Allowed minimum pulley pitch diameter	40	67	118	180	300	450

- Calculate the large pulley pitch diameter.

$$D_p = d_p \times SR$$

D_p : Large pulley pitch diameter (mm)
 d_p : Small pulley pitch diameter (mm)
 SR : Speed ratio

Difference between pulley outside diameter and pitch diameter is specified in the following table.

Difference between pulley outside diameter and pitch diameter Unit : mm Table 2-5

Belt type	M	A	B	C	D	E
Difference	5.4	9.0	11.0	14.0	19.0	25.4

Design Flow



Determine the belt length.

- 1) Determine the interim belt pitch length.

$$L_p' = 2C' + 1.57(D_p + d_p)$$

L_p' : Interim belt pitch length (mm)
 C' : Interim center distance (mm)
 D_p : Large pulley pitch diameter (mm)
 d_p : Small pulley pitch diameter (mm)

- 2) Select the standard belt length closest to the L_p' from our lineup.

Center distance is calculated from the following formula.

$$C = \frac{b + \sqrt{b^2 - 8(D_p - d_p)^2}}{8}$$

C : Center distance (mm)
 b : $2L_p - \pi(D_p + d_p)$
 L_p : Belt pitch length (mm)

- 3) If center distance is predetermined, use the following formula to determine interim belt pitch length.

$$L_p' = 2C + \frac{\pi}{2}(D_p + d_p) + \frac{(D_p - d_p)^2}{4C}$$



6

Determine the required number of belts.

Required number of belts (nb) is determined as follows.
Round up the calculation results.

$$nb = \frac{Pd}{Pc}$$

$$\uparrow Pc = (Ps + Pa) \times Kc$$

$$\uparrow Kc = K\theta \times K\ell$$

$$\uparrow K\ell = \frac{Dp - dp}{C}$$

- nb : Required number of belts
- Pd : Design power (kW)
- Pc : Correction power rating (kW)
- Ps : Basic power rating (kW)
- Pa : Additional power rating for speed ratio (kW)
- Kc : Power rating correction factor
- Kθ : Arc of contact correction factor
- Kℓ : Belt length correction factor
- Dp : Large pulley pitch diameter (mm)
- dp : Small pulley pitch diameter (mm)
- C : Center distance (mm)

● Arc of contact correction factor : Kθ Table 2-6

$\frac{Dp-dp}{C}$	Contact angle on small pulley θ(°)	Kθ
0.00	180	1.00
0.10	174	0.99
0.20	169	0.97
0.30	163	0.96
0.40	157	0.94
0.50	151	0.93
0.60	145	0.91
0.70	139	0.89
0.80	133	0.87
0.90	127	0.85
1.00	120	0.82
1.10	113	0.80
1.20	106	0.77
1.30	99	0.73
1.40	91	0.70
1.50	83	0.65

Contact angle on small pulley : $\theta = 180 - 2\sin^{-1} \frac{Dp - dp}{2C}$

Contact angle on large pulley : $\theta = 180 + 2\sin^{-1} \frac{Dp - dp}{2C}$

- Dp : Large pulley pitch diameter (mm)
- dp : Small pulley pitch diameter (mm)
- C : Center distance (mm)

● Belt length correction factor for Classical V-Belts: Kℓ Table 2-7

Length designation	Belt length correction factor : Kℓ				
	A	B	C	D	E
20 ~ 25	0.77	0.72			
26 ~ 30	0.82	0.76			
31 ~ 34	0.85	0.79			
35 ~ 37	0.87	0.81	0.71		
38 ~ 41	0.89	0.83	0.73		
42 ~ 45	0.91	0.85	0.75		
46 ~ 50	0.93	0.87	0.77		
51 ~ 54	0.94	0.89	0.78		
55 ~ 59	0.96	0.91	0.80		
60 ~ 67	0.98	0.93	0.82		
68 ~ 74	1.01	0.95	0.84		
75 ~ 79	1.03	0.97	0.86		
80 ~ 84	1.04	0.98	0.87		
85 ~ 89	1.05	0.99	0.89		
90 ~ 95	1.07	1.01	0.90		
96 ~ 104	1.08	1.03	0.91	0.81	
105 ~ 111	1.10	1.04	0.93	0.82	
112 ~ 119	1.12	1.06	0.94	0.84	
120 ~ 127	1.13	1.07	0.96	0.85	
128 ~ 144	1.15	1.09	0.98	0.87	0.85
145 ~ 154	1.18	1.11	1.00	0.89	0.87
155 ~ 169	1.19	1.13	1.02	0.91	0.88
170 ~ 179	1.21	1.15	1.03	0.92	0.90
180 ~ 194	1.23	1.17	1.05	0.94	0.91
195 ~ 209	1.25	1.18	1.07	0.95	0.93
210 ~ 239	1.27	1.21	1.09	0.98	0.95
240 ~ 269	1.30	1.24	1.12	1.00	0.98
270 ~ 299	1.33	1.26	1.14	1.03	1.00
300 ~ 329	1.35	1.29	1.17	1.05	1.02
330 ~ 359	1.38	1.31	1.19	1.07	1.04
360 ~ 389	1.40	1.33	1.21	1.09	1.06
390 ~ 419		1.35	1.22	1.11	1.08
420 ~ 479		1.38	1.25	1.13	1.10
480 ~ 539		1.41	1.28	1.16	1.13
540 ~ 600		1.44	1.31	1.18	1.16
601 ~ 660		1.46	1.33	1.21	1.18

● Belt length correction factor for Narrow V-Belts: Kℓ Table 2-8

Length designation	Belt length correction factor : Kℓ			
	SPZ SPZX	SPA SPAX	SPB SPBX	SPC SPCX
487 ~ 670	0.80			
671 ~ 755	0.84	0.79		
756 ~ 850	0.86	0.81		
851 ~ 950	0.89	0.83		
951 ~ 1060	0.91	0.85		
1061 ~ 1185	0.93	0.87		
1186 ~ 1325	0.95	0.89	0.82	
1326 ~ 1500	0.98	0.91	0.84	
1501 ~ 1700	1.00	0.93	0.86	
1701 ~ 1900	1.02	0.95	0.88	
1901 ~ 2120	1.05	0.96	0.90	0.82
2121 ~ 2370	1.07	0.98	0.92	0.84
2371 ~ 2650	1.09	1.00	0.94	0.86
2651 ~ 2975	1.11	1.02	0.96	0.88
2976 ~ 3350	1.13	1.04	0.98	0.90
3351 ~ 3775	1.16	1.06	1.00	0.92
3776 ~ 4250	1.18	1.08	1.02	0.94
4251 ~ 4750	1.20	1.10	1.04	0.96
4751 ~ 5300		1.12	1.06	0.98
5301 ~ 5950			1.08	1.00
5951 ~ 6700			1.10	1.02
6701 ~ 7550			1.12	1.04
7551 ~ 8500			1.14	1.06
8501 ~ 9500			1.16	1.08
9501 ~ 10000			1.17	1.10

7

Installation and take-up allowance.

Installation and take-up allowance are as follows.
Use idler pulley if you cannot arrange allowance.

Fig. 2-4

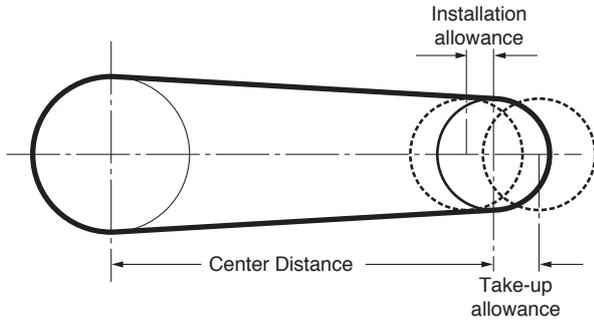

● Installation and take-up allowance for Classical V-Belts

Table 2-9

Length designation	Pitch length (mm)	Installation allowance (mm)						Take-up allowance (mm)
		M	A	B	C	D	E	All sections
20 ~ 38	$500 \leq L_p < 970$	15	20	25				25
39 ~ 60	$970 \leq L_p < 1500$	20	20	25	40			40
61 ~ 90	$1500 \leq L_p < 2200$		20	35	40			50
91 ~ 120	$2200 \leq L_p < 3000$		25	35	40			65
121 ~ 158	$3000 \leq L_p < 4000$		25	35	40	50		75
159 ~ 195	$4000 \leq L_p < 5000$			35	50	50	65	90
196 ~ 240	$5000 \leq L_p < 6000$			40	50	50	65	100
241 ~ 270	$6000 \leq L_p < 6800$				50	65	65	115
271 ~ 330	$6800 \leq L_p < 8400$				50	65	75	130
331 ~ 400	$8400 \leq L_p < 10000$				50	65	75	155
400 ~	$10000 \leq L_p$					75	90	$L_p \times 0.015$

● Installation and take-up allowance for Narrow V-Belts

Table 2-10

Length designation	Installation allowance (mm)				Take-up allowance (mm)
	SPZ SPZX	SPA SPAX	SPB SPBX	SPC SPCX	All sections
487 ~ 670	16	19			10
670 ~ 1000	18	21			10
1000 ~ 1320	19	22	27		13
1320 ~ 1662	21	24	29		17
1662 ~ 2240	24	27	32	39	22
2240 ~ 3000	28	31	35	43	30
3000 ~ 3550	30	33	38	46	36
3550 ~ 4500	35	38	43	51	45
4500 ~ 5600	41	44	48	56	56
5600 ~ 6700	46		54	62	67
6700 ~ 8500	55		63	71	85
8500 ~ 10000			70	78	100

Calculation example for Classical V-Belts / Narrow V-Belts

Design Flow

1 Set conditions required in design work.

- | | |
|--|---|
| a. Type of machine ... Compressor | e. Speed ratio ... 2 : 1 (Deceleration) |
| b. Transmission power ... Four pole motor 3.75kW/1750rpm | f. Interim center distance ... 300mm |
| c. Running hours in a single day ... 8 hours / day | g. Special uses and environmental conditions ... None |
| d. Small pulley speed ... 1750rpm | |

Design Flow

2 Set the design power.

Service correction factor : $K_o = 1.3$ (Table 2-1)
 Idler correction factor : $K_i = 0$ (Table 2-2)
 Environment correction factor : $K_e = 0$ (Table 2-3)
 Service factor : $K_s = K_o + K_i + K_e$
 $= 1.3 + 0 + 0$
 $= 1.3$
 Design power : $P_d = P_t \times K_s$
 $= 3.75 \times 1.3$
 $= 4.88 \text{ kW}$

Design Flow

3 Select the belt type.

Select the belt type in Cross section selection chart.
 The lines of P_d (4.88kW) and small pulley speed (1750rpm) intersect in A section.

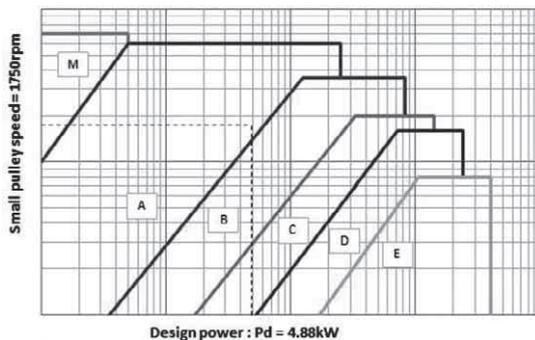

Design Flow

4 Select the pulley size.

- 1) Select the small pulley of 95mm pitch diameter.
 (The recommended minimum pulley pitch diameter is specified in Table 2-4.)
- 2) Calculate the large pulley pitch diameter.

$$\begin{aligned} \text{Large pulley pitch diameter : } D_p &= d_p \times SR \\ &= 95 \times 2 \\ &= 190 \text{ mm} \end{aligned}$$

Design Flow

5 Determine the belt length.

- 1) Determine the interim belt pitch length.

$$L_p' = 2 \times 300 + 1.57 \times (190 + 95) = 1047.5 \text{ mm}$$

- 2) Select the standard belt length closest to the L_p' from Table 1-2.

Belt pitch length 1041mm : Length designation A41 is selected.

Center distance is calculated as follows.

$$\begin{aligned} b &= 2 \times 1041 - 3.14 \times (190 + 95) = 1187 \\ C &= \frac{1187 + \sqrt{1187^2 - 8 \times (190 - 95)^2}}{8} = 292.9 \\ \text{Center distance : } C &= 293 \text{ mm} \end{aligned}$$

Design Flow

6 Determine the required number of belts.

$$\begin{aligned} P_s &= 2.16 \text{ kW (Refer to Power Rating Table)} \\ P_a &= 0.37 \text{ kW (Refer to Power Rating Table)} \\ \frac{D_p - d_p}{C} &= \frac{190 - 95}{293} = 0.32 \\ K_\theta &= 0.96 \text{ (Refer to Table 2-6).} \\ K_l &= 0.89 \text{ (Refer to Table 2-7).} \\ K_c &= K_\theta \times K_l = 0.96 \times 0.89 = 0.85 \\ P_c &= (P_s + P_a) \times K_c = (2.16 + 0.37) \times 0.85 = 2.15 \text{ kW} \\ n_b &= \frac{P_d}{P_c} = \frac{4.88}{2.15} = 2.3 \rightarrow 3 \text{ pcs.} \end{aligned}$$

Design Flow

7 Installation and take-up allowance.

Installation and take-up allowance are obtained from Table 2-9.

$$\begin{aligned} \text{Installation allowance} &= 20 \text{ mm} \\ &\rightarrow \text{Minimum center distance} = 293 - 20 = 273 \text{ mm} \\ \text{Take-up allowance} &= 40 \text{ mm} \\ &\rightarrow \text{Maximum center distance} = 293 + 40 = 333 \text{ mm} \end{aligned}$$



Design process for Maxstar Wedge V-Belts

Design Flow

1 Set conditions required in design work.

a. Type of machine

b. Transmission power

It is ideal to use the actual load applied to the belt as the value of the transmission power, but the rated power of the motor is commonly used for calculation.

c. Running hours in a single day

d. Small pulley speed

e. Speed ratio

$$\text{Speed ratio} = \frac{\text{Large pulley pitch diameter}}{\text{Small pulley pitch diameter}}$$

f. Interim center distance

g. Special uses and environmental conditions

Contact us for the case of exposure to high or low temperature, water, oil, acid or alkali.

Design Flow

2 Set the design power.

1. How to calculate the service factor (Ks)

$$K_s = K_o + K_i + K_e$$

Wherein, Ks : Service factor

Ko : Service correction factor >> (Table 2-11)

Ki : Idler correction factor >> (Table 2-12)

Ke : Environment correction factor >> (Table 2-13)

2. How to calculate the design power (Pd)

$$P_d = P_t \times K_s$$

Wherein, Pd : Design power (kW)

Pt : Transmission power (kW)

Ks : Service factor

The value of transmission power used in designing is the power requirement of the driven machine, if obtained, or the power of driving unit (engine or motor).

Convert the value from torque (Tq) or horse power (PS) into kW with the formula below.

$$P_t = \frac{T_q \times n}{9.55 \times 10^3}$$

Wherein, Pt : Transmission power (kW)

Tq : Torque (N·m)

n : Shaft speed (rpm)

$$1 \text{ PS} = 0.7355 \text{ kW}$$

2

Design



1. Ko

Service correction factor (Ko)

Table 2-11

Driven Machine	Driving unit / Motor					
	Max power \leq 300% of rated power			Max power $>$ 300% of rated power		
	AC motors, single-and three-phase with star-delta start. DC shunt-wound motors, Multiple cylinder internal combustion engines.			AC motors, single and three-phase, series wound, slip-ring motors with direct start. DC motors, series and compound wound. Single cylinder internal combustion engines.		
	Running time (hrs./day)			Running time (hrs./day)		
	3 ~ 5	8 ~ 12	16 ~ 24	3 ~ 5	8 ~ 12	16 ~ 24
<ul style="list-style-type: none"> ● Agitator for liquid ● Small centrifugal blower ● Fan up to 7.5 kW ● Light-duty conveyor 	1.0	1.1	1.2	1.1	1.2	1.3
<ul style="list-style-type: none"> ● Belt conveyor (for sand, grain, etc.) ● Dough mixer ● Fan over 7.5 kW ● Generator ● Machine tool ● Punching machine ● Pressing machine ● Shearing machine ● Printing machine ● Positive displacement rotary pump ● Vibrating and rotary screen 	1.1	1.2	1.3	1.2	1.3	1.4
<ul style="list-style-type: none"> ● Brick-making machinery ● Bucket elevator ● Piston compressor ● Screw conveyor ● Hammer mill ● Hollander ● Piston pump ● Positive displacement blower ● Crusher ● Woodworking machinery ● Textile machinery 	1.2	1.3	1.4	1.4	1.5	1.6
<ul style="list-style-type: none"> ● Gyratory and jaw-roll crusher ● Mill (ball/rod) ● Hoist (heavy load) ● Rolling mill, calender etc, for the rubber and plastic industry 	1.3	1.4	1.5	1.5	1.6	1.8



2. Ki

Idler correction factor (Ki)

Table 2-12

Location of Idler	Ki
Belt slack side, inside of belt	0.0
Belt slack side, outside of belt	0.1
Belt tight side, inside of belt	0.1
Belt tight side, outside of belt	0.2

3. Ke

Environment correction factor (Ke)

Table 2-13

Environmental condition	Ke
Frequent start and stop of machine	0.2
Hard to conduct maintenance checkup	0.2
Dusty environment	0.2
High temperature	0.2
Oil or water splashing	0.2

● Avoid oil and water splash by cover to prevent belt slipping.

3

Select the belt type.

● Select the belt type in the selection charts below according to design power and small pulley speed.

● If the intersection locates near the dividing line, select belt type considering other conditions such as pulley cost.

Cross section selection chart for Maxstar Wedge V-Belts

Fig. 2-5

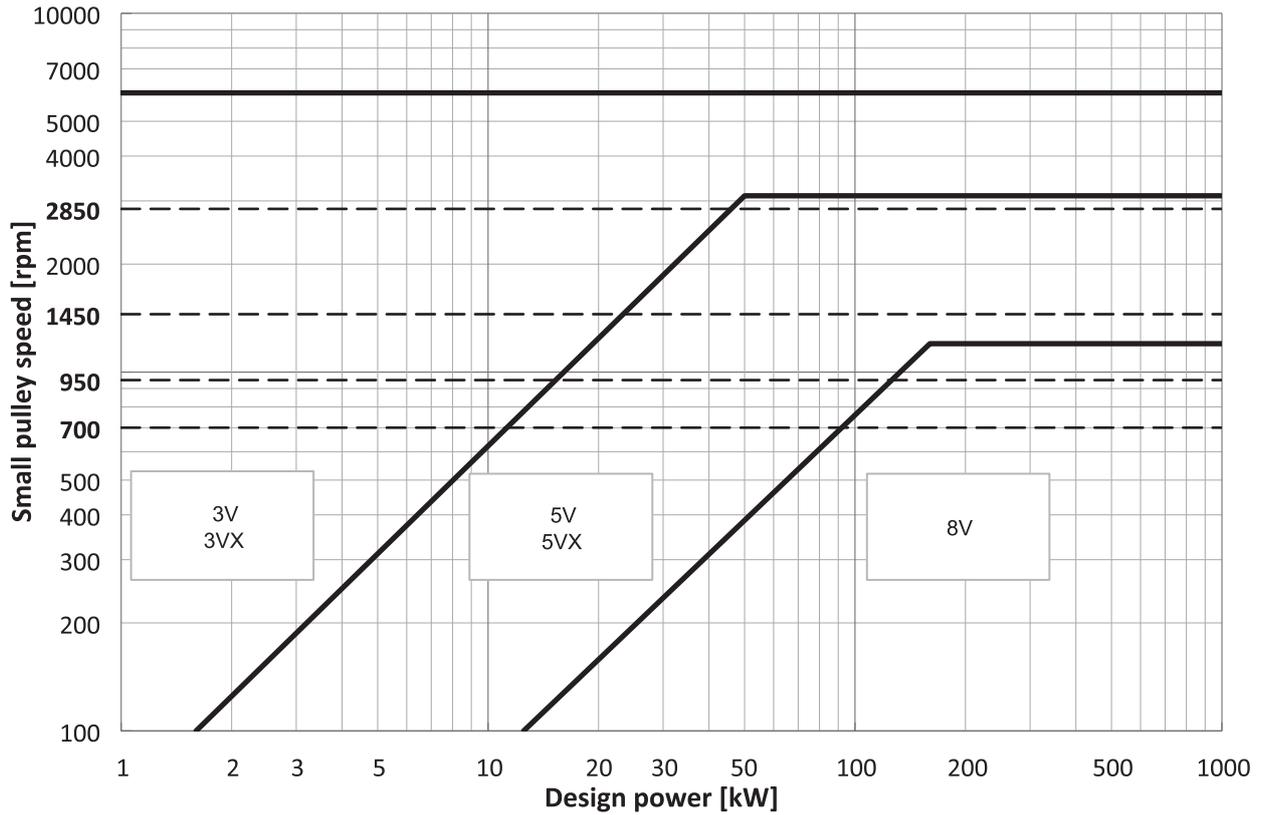

2

Design

Design Flow

4

Select the pulley size.

4-A : Select from the standard pulleys.

You can obtain pulley size, belt length, and center distance easily by using Drive Selection Table on page 2-43 ~ 2-62.

Speed ratio	Effective diameter (mm)		Center distance (mm)						
	Small pulley	Large pulley	3V 250	3V 265	3V 280	3V 300	3V 315	3V 335	3V 355
1.48	85	125	151	170	190	215	234	260	285
1.48	95	140	131	150	169	195	214	240	265
1.50	67	100	186	205	224	249	268	294	319
1.50	75	112	170	189	208	233	252	278	304
1.51	100	150	-	138	157	183	202	228	253
1.56	90	140	135	154	173	193	213	244	269
1.57	80	125	155	174	193	219	238	264	289
1.57	160	250	-	-	-	-	-	-	-
1.58	200	315	-	-	-	-	-	-	-
1.59	71	112	173	192	211	236	255	281	307

- 1) Choose the speed ratio to satisfy your drive design.
- 2) Choose the pulley size.
- 3) Choose the center distance.
- 4) Look up to find the belt length.
→Go to design flow ⑥

4-B : With the nonstandard pulley.

Follow the procedure below if you cannot find the desired speed ratio in the Drive Selection Table.

- 1) Choose the speed ratio closest to the desired speed ratio.
- 2) Choose the large pulley from the standard pulleys.
- 3) Calculate the effective diameter of the small pulley from the following formula.

$$de = \frac{D_p}{SR} + (\text{Difference between effective diameter and pitch diameter})$$

de : Small pulley effective diameter
Dp : Large pulley pitch diameter
SR : Speed ratio

Difference between effective diameter and pitch diameter Table 2-14

Belt type	3V-3VX	5V-5VX	8V
Difference (mm)	1.2	2.6	5.0

Pulley diameter should be larger than the minimum pulley effective diameter specified in Table 2-15.

Minimum pulley effective diameter Table 2-15

Belt type	3V	3VX	5V	5VX	8V
Minimum pulley effective diameter (mm)	67	56	180	112	315

Design Flow

5

Determine the belt length.

5-A : Determine from Drive Selection Table.

- 1) Choose the speed ratio and center distance closest to your drive in Drive Selection Table on page 2-43 ~ 2-62.
- 2) Precise center distance is calculated by adding the following correction value to the center distance in Drive Selection Table.

$$\text{Center distance correction value} = 0.8 \times (\text{Effective diameter of the standard small pulley} - \text{Effective diameter of the calculated small pulley})$$

5-B : Determine from the calculation formula.

- 1) Determine the interim belt effective length.

$$Le' = 2C' + 1.57(De + de)$$

Le' : Interim belt effective length (mm)
C' : Interim center distance (mm)
De : Large pulley effective diameter (mm)
de : Small pulley effective diameter (mm)

- 2) Select the standard belt length closest to the Lp' from our lineup.

Center distance is calculated by the following formula.

$$C = \frac{b + \sqrt{b^2 - 8(De - de)^2}}{8}$$

C : Center distance (mm)
b : $2Le - \pi(De + de)$
Le : Belt effective length (mm)



6

Determine the required number of belts.

Required number of belts (nb) is determined as follows.
Round up the calculation results.

$$nb = \frac{Pd}{Pc}$$

↑ $Pc = (Ps + Pa) \times Kc$

↑ $Kc = K\theta \times K\ell$

↑ $\frac{De - de}{C}$

- nb : Required number of belt
- Pd : Design power (kW)
- Pc : Correction power rating (kW)
- Ps : Basic power rating (kW)
- Pa : Additional power rating for speed ratio (kW)
- Kc : Power rating correction factor
- Kθ : Arc of contact correction factor
- Kℓ : Belt length correction factor
- De : Large pulley effective diameter (mm)
- de : Small pulley effective diameter (mm)
- C : Center distance (mm)

With the standard pulley, you can obtain Kc easily from Drive Selection Table.

Kc is as in Color coding below.

Color coding of Power rating correction factor : Kc

0.7	0.8	0.9	1.0	1.1	1.2
-----	-----	-----	-----	-----	-----

● Arc of contact correction factor : Kθ Table 2-16

$\frac{De-de}{C}$	Contact angle on small pulley θ(°)	Kθ
0.00	180	1.00
0.10	174	0.99
0.20	169	0.97
0.30	163	0.96
0.40	157	0.94
0.50	151	0.93
0.60	145	0.91
0.70	139	0.89
0.80	133	0.87
0.90	127	0.85
1.00	120	0.82
1.10	113	0.80
1.20	106	0.77
1.30	99	0.73
1.40	91	0.70
1.50	83	0.65

Contact angle on small pulley : $\theta = 180 - 2\sin^{-1} \frac{De - de}{2C}$

Contact angle on large pulley : $\theta = 180 + 2\sin^{-1} \frac{De - de}{2C}$

- De : Large pulley effective diameter (mm)
- de : Small pulley effective diameter (mm)
- C : Center distance (mm)

● Belt length correction factor for Maxstar Wedge V-Belts: Kℓ Table 2-17

Length designation	Belt length correction factor : Kℓ		
	3V 3VX	5V 5VX	8V
250	0.83		
265	0.84		
280	0.85		
300	0.86		
315	0.87		
335	0.88		
355	0.89		
375	0.90		
400	0.92		
425	0.93		
450	0.94		
475	0.95		
500	0.96	0.85	
530	0.97	0.86	
560	0.98	0.87	
600	0.99	0.88	
630	1.00	0.89	
670	1.01	0.90	
710	1.02	0.91	
750	1.03	0.92	
800	1.04	0.93	
850	1.06	0.94	
900	1.07	0.95	
950	1.08	0.96	
1000	1.09	0.96	0.87
1060	1.10	0.97	0.88
1120	1.11	0.98	0.88
1180	1.12	0.99	0.89
1250	1.13	1.00	0.90
1320	1.14	1.01	0.91
1400	1.15	1.02	0.92
1500		1.03	0.93
1600		1.04	0.94
1700		1.05	0.94
1800		1.06	0.95
1900		1.07	0.96
2000		1.08	0.97
2120		1.09	0.98
2240		1.09	0.98
2360		1.10	0.99
2500		1.11	1.00
2650		1.12	1.01
2800		1.13	1.02
3000		1.14	1.03
3150		1.15	1.03
3350		1.16	1.04
3550		1.17	1.05
3750			1.06
4000			1.07
4250			1.08
4500			1.09
4750			1.09
5000			1.10
5600			1.11
6000			1.13



7

Installation and take-up allowance.

Installation and take-up allowance are as follows.
Use idler pulley if you cannot arrange allowance.

Fig. 2-6

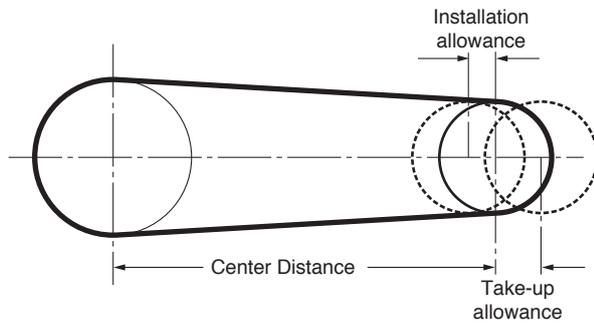

● Installation and take-up allowance for Maxstar Wedge V-Belts

Table 2-18

Length designation	Installation allowance (mm)	Take-up allowance (mm)	Sum of installation and take-up allowance (mm)
3V250 ~ 3V475	15	25	40
3V500 ~ 3V710	20	35	55
3V750 ~ 3V1060	20	40	60
3V1120 ~ 3V1250	20	50	70
3V1320, 3V1400	20	60	80
5V500 ~ 5V710	25	35	60
5V750 ~ 5V1060	25	40	65
5V1120 ~ 5V1250	25	50	75
5V1320 ~ 5V1700	25	60	85
5V1800 ~ 5V2000	25	65	90
5V2120 ~ 5V2240	35	75	110
5V2360	35	80	115
5V2500, 5V2560	35	85	120
5V2800, 5V3000	35	90	125
5V3150, 5V3550	35	105	140
8V1000, 8V1060	40	40	80
8V1120 ~ 8V1250	40	50	90
8V1320 ~ 8V1700	40	60	100
8V1800 ~ 8V2000	50	65	115
8V2120 ~ 8V2240	50	75	125
8V2360	50	80	130
8V2500, 8V2650	50	85	135
8V2800, 8V3000	50	90	140
8V3150	50	105	155
8V3350, 8V3550	55	105	160
8V3750	55	115	170
8V4000 ~ 8V5600	55	140	195

Calculation example for Maxstar Wedge V-Belts #1 (With the standard pulley)

Design Flow

1 Set conditions required in design work.

- | | |
|--|---|
| a. Type of machine ... Blower | e. Speed ratio ... 1.87 (Deceleration) |
| b. Transmission power ... 3.7kW | f. Interim center distance ... 400mm |
| c. Running hours in a single day ... 8 hours / day | g. Special uses and environmental conditions ... None |
| d. Small pulley speed ... 1750rpm | |

Design Flow

2 Set the design power.

Service correction factor : $K_o = 1.1$ (Table 2-11)
 Idler correction factor : $K_i = 0$ (Table 2-12)
 Environment correction factor : $K_e = 0$ (Table 2-13)
 Service factor : $K_s = K_o + K_i + K_e$
 $= 1.1 + 0 + 0$
 $= 1.1$
 Design power : $P_d = P_t \times K_s$
 $= 3.7 \times 1.1$
 $= 4.07 \text{ kW}$

Design Flow

6 Determine the required number of belts.

$P_s = 1.69 \text{ kW}$ (Refer to Power Rating Table)
 $P_a = 0.26 \text{ kW}$ (Refer to Power Rating Table)
 $K_c = 0.9$ (Refer to Drive Selection Table)
 $P_c = (P_s + P_a) \times K_c = (1.69 + 0.26) \times 0.9 = 1.76 \text{ kW}$
 $n_b = \frac{P_d}{P_c} = \frac{4.07}{1.76} = 2.3 \rightarrow 3 \text{ pcs.}$

Design Flow

3 Select the belt type.

Select the belt type in Cross section selection chart.
 The lines of P_d (4.07kW) and small pulley speed (1750rpm) intersect in 3V section.

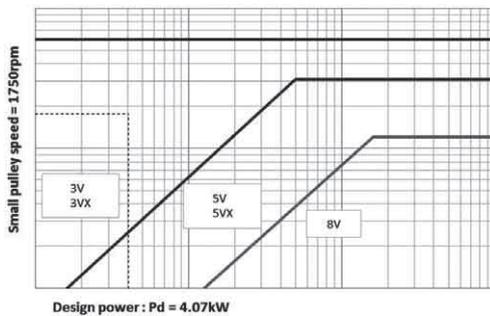

Design Flow

7 Installation and take-up allowance.

Installation and take-up allowance are obtained from Table 2-18.

Installation allowance = 15 mm
 \rightarrow Minimum center distance = $401 - 15 = 386 \text{ mm}$
 Take-up allowance = 25 mm
 \rightarrow Maximum center distance = $401 + 25 = 426 \text{ mm}$

Design Flow

4 **5** Select the pulley size.
 Determine the belt length.

Speed ratio	Effective diameter (mm)		Center distance (mm)						
	Small pulley	Large pulley	3V 250	3V 265	3V 355	3V 375	3V 400	3V 425	3V 450
1.88 1)	67	125 2)	164	183	299	324	356	388	400
1.88	75	140	145	164	280	300	332	370	401
1.89	80	150	132	152	268	294	325	358	389
1.89	85	160	-	139	256	282	313	346	377
1.91	95	180	-	-	231	257	289	321	353

Small pulley effective diameter : $d_e = 75 \text{ mm}$
 Large pulley effective diameter : $D_e = 140 \text{ mm}$
 Center distance : $C = 401 \text{ mm}$
 Belt size = 3V-450

2
Design

Calculation example for Maxstar Wedge V-Belts #2 (With nonstandard pulley)

Design Flow

1 Set conditions required in design work.

- | | |
|--|---|
| a. Type of machine ... Generator | e. Speed ratio ... 1.65 (Deceleration) |
| b. Transmission power ... 37kW (Gasoline engine) | f. Interim center distance ... 1500mm |
| c. Running hours in a single day ... 8 hours / day | g. Special uses and environmental conditions ... None |
| d. Small pulley speed ... 1000rpm | |

Design Flow

2 Set the design power.

Service correction factor : $K_o = 1.3$ (Table 2-11)
 Idler correction factor : $K_i = 0$ (Table 2-12)
 Environment correction factor : $K_e = 0$ (Table 2-13)
 Service factor : $K_s = K_o + K_i + K_e$
 $= 1.3 + 0 + 0$
 $= 1.3$
 Design power : $P_d = P_t \times K_s$
 $= 37 \times 1.3$
 $= 48.1 \text{ kW}$

Design Flow

5 Determine the belt length.

1) Center distance = 1507 mm (5V-1500) is chosen from the SR = 1.67 in Drive Selection Table.

2) Precise center distance is calculated as follows.
 Effective diameter of the standard small pulley = 190 mm
 Effective diameter of the calculated small pulley = 192 mm

$$C = 1507 + 0.8 \times (190 - 192)$$

$$\doteq 1505 \text{ mm}$$

Center distance is also calculated as follows.

$$b = 2L_e - \pi (D_e + d_e)$$

$$= 2 \times 3810 - 3.14 \times (315 + 192)$$

$$\doteq 6028$$

$$C = \frac{b + \sqrt{b^2 - 8(D_e - d_e)^2}}{8}$$

$$= \frac{6028 + \sqrt{6028^2 - 8(315 - 192)^2}}{8}$$

$$\doteq 1505.7 \text{ mm}$$

Design Flow

3 Select the belt type.

Select the belt type in the cross section selection chart. The lines of P_d (48.1kW) and small pulley speed (1000rpm) intersect in 5V section.

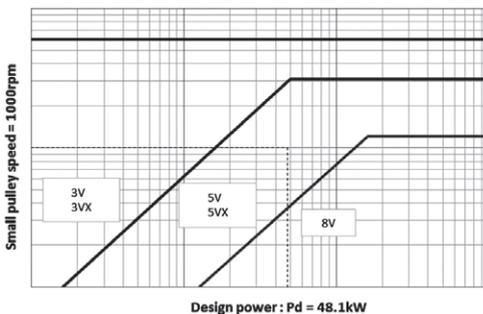

Design Flow

4 Select the pulley size.

- 1) Choose the speed ratio closest to the desired speed ratio.
- 2) Choose the large pulley from the standard pulley.

Large pulley effective diameter : $D_e = 315 \text{ mm}$
 is chosen from the SR = 1.67 in Drive Selection Table.

- 3) Calculate the small pulley effective diameter.

$$d_e = \frac{315 - 2.6}{1.65} + 2.6$$

$$\doteq 192 \text{ mm}$$



Design Flow

6

Determine the required number of belts.

$P_s = 9.42 \text{ kW}$ (Refer to Power Rating Table)

$P_a = 0.85 \text{ kW}$ (Refer to Power Rating Table)

$$\frac{D_e - d_e}{C} = \frac{315 - 192}{1505} = 0.082$$

$K_\theta = 0.99$ (Refer to Table 2-16).

$K_l = 1.03$ (Refer to Table 2-17).

$K_c = K_\theta \times K_l = 0.99 \times 1.03 = 1.02$

$P_c = (P_s + P_a) \times K_c = (9.42 + 0.85) \times 1.02 = 10.48 \text{ kW}$

$$n_b = \frac{P_d}{P_c} = \frac{48.1}{10.48} = 4.6 \rightarrow 5 \text{ pcs.}$$

Design Flow

7

Installation and take-up allowance.

Installation and take-up allowance are obtained from Table 2-18.

Installation allowance = 25 mm

→ Minimum center distance = $1505 - 25 = 1480 \text{ mm}$

Take-up allowance = 60 mm

→ Maximum center distance = $1505 + 60 = 1565 \text{ mm}$

●**Summary**

Belt : 5V-1500, 5 pcs.

Driver pulley : 192-5V-5 (Effective diameter = 192mm, 5 grooves)

Driven pulley : 315-5V-5 (Effective diameter = 315mm, 5 grooves)

Center distance : 1505mm (+60mm / -25mm)



Formulas for V-Belt drives design

Table 2-19

Item	Formula	Term
Design power	$P_d = P_t \times K_s$	P_d : Design power (kW) P_t : Transmission power (kW) K_s : Service factor
Service factor	$K_s = K_o + K_i + K_e$	K_s : Service factor K_o : Service correction factor K_i : Idler correction factor K_e : Environment correction factor
Power rating	$P_r = P_s + P_a$	P_r : Power rating (kW) P_s : Basic power rating (kW) P_a : Additional power rating for speed ratio (kW)
Correction power rating	$P_c = P_r \times K_l \times K_\theta$	P_c : Correction power rating (kW) P_r : Power rating (kW) K_l : Belt length correction factor K_θ : Arc of contact correction factor
Speed ratio	$SR = \frac{n_d}{n_D} = \frac{D_p}{d_p}$	SR : Speed ratio n_d : Small pulley speed (rpm) n_D : Large pulley speed (rpm) D_p : Large pulley pitch diameter (mm) d_p : Small pulley pitch diameter (mm)
Interim effective length	$Le' = 2C' + 1.57(D_e + d_e)$	Le' : Interim effective length (mm) C' : Interim center distance (mm) D_e : Large pulley effective diameter (mm) d_e : Small pulley effective diameter (mm)
Effective length	$Le = 2C + \frac{\pi(D_e + d_e)}{2} + \frac{(D_e - d_e)^2}{4C}$	Le : Effective length (mm) C : Center distance (mm) D_e : Large pulley effective diameter (mm) d_e : Small pulley effective diameter (mm) π : 3.1416
Center distance	$C = \frac{b + \sqrt{b^2 - 8(D_e - d_e)^2}}{8}$ $b = 2Le - \pi(D_e + d_e)$	C : Center distance (mm) D_e : Large pulley effective diameter (mm) d_e : Small pulley effective diameter (mm) Le : Effective length (mm) π : 3.1416
Arc of contact	$\theta = 180^\circ - \frac{57.3(D_e - d_e)}{C}$	θ : Arc of contact for small pulley (°) D_e : Large pulley effective diameter (mm) d_e : Small pulley effective diameter (mm) C : Center distance (mm)
Number of belts	$n_b = \frac{P_d}{P_c}$	n_b : Number of belts P_d : Design power (kW) P_c : Correction power rating (kW)

Table 2-19

Item	Formula	Term
Belt speed	$V = \frac{\pi \times dp \times nd}{60 \times 1000} = \frac{dp \times nd}{19100}$	V : Belt speed (m/sec.) dp : Small pulley pitch diameter (mm) nd : Small pulley speed (rpm)
Transmission power	$Pt = \frac{Te \times V}{1000}$	Pt : Transmission power (kW) Te : Effective tension (N) V : Belt speed (m/sec.)
Transmission power	$Pt = \frac{Tq \times n}{9.55 \times 10^3}$	Pt : Transmission power (kW) Tq : Torque (N·m) n : Pulley speed (rpm)
Effective tension	$Te = \frac{2Tq}{dp} \times 1000$	Te : Effective tension (N) Tq : Torque (N·m) dp : Small pulley pitch diameter (mm)
Effective tension	$Te = \frac{1000 \times Pt}{V}$	Te : Effective tension (N) Pt : Transmission power (kW) V : Belt speed (m/sec.)
Torque	$Tq = Te \times \frac{dp}{2} \times \frac{1}{1000}$	Tq : Torque (N·m) Te : Effective tension (N) dp : Small pulley pitch diameter (mm)
Tight side tension	$Tt = \frac{1000 \times Pd}{nb \times V} \times \frac{2.5}{2 \times K\theta} + W \times V^2$	Tt : Tight side tension (N) Pd : Design power (kW) nb : Number of belts V : Belt speed (m/sec.) Kθ : Arc of contact correction factor W : Belt weight per unit (kg/m)
Slack side tension	$Ts = \frac{1000 \times Pd}{nb \times V} \times \frac{2.5 - 2 \times K\theta}{2 \times K\theta} + W \times V^2$	Ts : Slack side tension (N) Pd : Design power (kW) nb : Number of belts V : Belt speed (m/sec.) Kθ : Arc of contact correction factor W : Belt weight per unit (kg/m)
Tension ratio	$TR = \frac{Tt}{Ts}$	TR : Tension ratio Tt : Tight side tension (N) Ts : Slack side tension (N)
Minimum static tension	$To = 0.9 \left\{ 500 \times \frac{(2.5 - K\theta)Pd}{K\theta \times nb \times V} + W \times V^2 \right\}$	To : Minimum static tension (N) Kθ : Arc of contact correction factor Pd : Design power (kW) nb : Number of belts V : Belt speed (m/sec.) W : Belt weight per unit (kg/m)
Static shaft load	$Fs = 1.5 \left(2nb \times To \times \sin \frac{\theta}{2} \right)$	Fs : Static shaft load (N) nb : Number of belts To : Minimum static tension (N) θ : Arc of contact for small pulley (°)
Span length	$Ls = \sqrt{C^2 - \frac{(De - de)^2}{4}}$	Ls : Span length (mm) C : Center distance (mm) De : Large pulley effective diameter (mm) de : Small pulley effective diameter (mm)



M-Section Power Rating

Table 2-20

[kw]

small pulley pitch speed nd(rpm)	Basic power rating for small pulley pitch diameter : Ps										Additional power rating for speed ratio (Pa)			
	Small pulley pitch diameter dp (mm)										Speed ratio			
	45	50	56	63	71	75	80	90	100	112	1.01 to 1.05	1.06 to 1.26	1.27 to 1.57	<1.57
700	0.17	0.22	0.28	0.34	0.41	0.45	0.49	0.58	0.66	0.76	0.00	0.02	0.03	0.03
950	0.21	0.28	0.35	0.43	0.53	0.57	0.63	0.74	0.85	0.99	0.00	0.02	0.04	0.04
1450	0.28	0.37	0.48	0.60	0.73	0.80	0.88	1.04	1.20	1.39	0.01	0.04	0.05	0.07
2850	0.42	0.58	0.76	0.97	1.21	1.32	1.46	1.74	2.00	2.31	0.01	0.07	0.11	0.13
100	0.04	0.05	0.06	0.07	0.08	0.09	0.09	0.11	0.12	0.14	0.00	0.00	0.00	0.00
200	0.07	0.08	0.10	0.12	0.14	0.16	0.17	0.20	0.23	0.26	0.00	0.01	0.01	0.01
300	0.09	0.11	0.14	0.17	0.20	0.22	0.24	0.28	0.32	0.37	0.00	0.01	0.01	0.01
400	0.11	0.14	0.18	0.22	0.26	0.28	0.31	0.36	0.41	0.48	0.00	0.01	0.01	0.02
500	0.14	0.17	0.21	0.26	0.31	0.34	0.37	0.44	0.50	0.58	0.00	0.01	0.02	0.02
600	0.15	0.20	0.24	0.30	0.36	0.39	0.43	0.51	0.58	0.67	0.00	0.02	0.02	0.03
700	0.17	0.22	0.28	0.34	0.41	0.45	0.49	0.58	0.66	0.76	0.00	0.02	0.03	0.03
800	0.19	0.24	0.31	0.38	0.46	0.50	0.55	0.64	0.74	0.85	0.00	0.02	0.03	0.04
900	0.21	0.27	0.33	0.41	0.50	0.55	0.60	0.71	0.82	0.94	0.00	0.02	0.03	0.04
1000	0.22	0.29	0.36	0.45	0.55	0.60	0.66	0.77	0.89	1.03	0.00	0.03	0.04	0.05
1100	0.24	0.31	0.39	0.48	0.59	0.64	0.71	0.84	0.96	1.11	0.00	0.03	0.04	0.05
1200	0.25	0.33	0.42	0.52	0.63	0.69	0.76	0.90	1.03	1.19	0.00	0.03	0.04	0.06
1300	0.27	0.35	0.44	0.55	0.67	0.73	0.81	0.96	1.10	1.27	0.01	0.03	0.05	0.06
1400	0.28	0.36	0.47	0.58	0.71	0.78	0.86	1.01	1.17	1.35	0.01	0.04	0.05	0.06
1500	0.29	0.38	0.49	0.61	0.75	0.82	0.90	1.07	1.24	1.43	0.01	0.04	0.06	0.07
1600	0.30	0.40	0.51	0.64	0.79	0.86	0.95	1.13	1.30	1.50	0.01	0.04	0.06	0.07
1700	0.31	0.42	0.54	0.67	0.83	0.90	1.00	1.18	1.36	1.58	0.01	0.04	0.06	0.08
1800	0.33	0.43	0.56	0.70	0.86	0.94	1.04	1.24	1.43	1.65	0.01	0.05	0.07	0.08
1900	0.34	0.45	0.58	0.73	0.90	0.98	1.09	1.29	1.49	1.72	0.01	0.05	0.07	0.09
2000	0.35	0.46	0.60	0.76	0.93	1.02	1.13	1.34	1.55	1.79	0.01	0.05	0.07	0.09
2100	0.36	0.48	0.62	0.79	0.97	1.06	1.17	1.39	1.60	1.85	0.01	0.06	0.08	0.10
2200	0.37	0.49	0.64	0.81	1.00	1.10	1.21	1.44	1.66	1.92	0.01	0.06	0.08	0.10
2300	0.38	0.51	0.66	0.84	1.04	1.13	1.25	1.49	1.72	1.98	0.01	0.06	0.09	0.11
2400	0.38	0.52	0.68	0.86	1.07	1.17	1.29	1.54	1.77	2.05	0.01	0.06	0.09	0.11
2500	0.39	0.53	0.70	0.89	1.10	1.20	1.33	1.58	1.83	2.11	0.01	0.07	0.09	0.11
2600	0.40	0.55	0.72	0.91	1.13	1.24	1.37	1.63	1.88	2.17	0.01	0.07	0.10	0.12
2700	0.41	0.56	0.74	0.94	1.16	1.27	1.41	1.67	1.93	2.23	0.01	0.07	0.10	0.12
2800	0.42	0.57	0.75	0.96	1.19	1.30	1.44	1.72	1.98	2.28	0.01	0.07	0.10	0.13
2900	0.42	0.58	0.77	0.98	1.22	1.34	1.48	1.76	2.03	2.34	0.01	0.08	0.11	0.13
3000	0.43	0.59	0.79	1.01	1.25	1.37	1.52	1.80	2.08	2.39	0.01	0.08	0.11	0.14
3100	0.44	0.61	0.80	1.03	1.28	1.40	1.55	1.84	2.12	2.44	0.01	0.08	0.12	0.14
3200	0.44	0.62	0.82	1.05	1.30	1.43	1.58	1.88	2.17	2.49	0.01	0.08	0.12	0.15
3300	0.45	0.63	0.83	1.07	1.33	1.46	1.62	1.92	2.21	2.54	0.01	0.09	0.12	0.15
3400	0.46	0.64	0.85	1.09	1.36	1.49	1.65	1.96	2.25	2.59	0.01	0.09	0.13	0.16
3500	0.46	0.65	0.86	1.11	1.38	1.52	1.68	2.00	2.30	2.64	0.01	0.09	0.13	0.16
3600	0.47	0.66	0.88	1.13	1.41	1.54	1.71	2.03	2.34	2.68	0.01	0.09	0.13	0.17
3700	0.47	0.67	0.89	1.15	1.43	1.57	1.74	2.07	2.38	2.72	0.02	0.10	0.14	0.17
3800	0.48	0.67	0.91	1.17	1.46	1.60	1.77	2.10	2.41	2.77	0.02	0.10	0.14	0.17
3900	0.48	0.68	0.92	1.19	1.48	1.62	1.80	2.13	2.45	2.81	0.02	0.10	0.15	0.18
4000	0.49	0.69	0.93	1.20	1.50	1.65	1.83	2.17	2.49	2.84	0.02	0.11	0.15	0.18
4100	0.49	0.70	0.94	1.22	1.53	1.67	1.85	2.20	2.52	2.88	0.02	0.11	0.15	0.19
4200	0.49	0.71	0.96	1.24	1.55	1.70	1.88	2.23	2.55	2.91	0.02	0.11	0.16	0.19
4300	0.50	0.71	0.97	1.25	1.57	1.72	1.90	2.26	2.58	2.95	0.02	0.11	0.16	0.20
4400	0.50	0.72	0.98	1.27	1.59	1.74	1.93	2.28	2.62	2.98	0.02	0.12	0.16	0.20
4500	0.50	0.73	0.99	1.28	1.61	1.76	1.95	2.31	2.64	3.01	0.02	0.12	0.17	0.21
4600	0.51	0.73	1.00	1.30	1.63	1.78	1.97	2.34	2.67	3.04	0.02	0.12	0.17	0.21
4700	0.51	0.74	1.01	1.31	1.65	1.80	2.00	2.36	2.70	3.06	0.02	0.12	0.18	0.22
4800	0.51	0.75	1.02	1.33	1.66	1.82	2.02	2.39	2.72	3.08	0.02	0.13	0.18	0.22
4900	0.51	0.75	1.03	1.34	1.68	1.84	2.04	2.41	2.75	3.11	0.02	0.13	0.18	0.22
5000	0.51	0.76	1.04	1.35	1.70	1.86	2.06	2.43	2.77	3.13	0.02	0.13	0.19	0.23
5100	0.52	0.76	1.05	1.37	1.71	1.88	2.08	2.45	2.79	3.14	0.02	0.13	0.19	0.23
5200	0.52	0.77	1.06	1.38	1.73	1.90	2.10	2.47	2.81	3.16	0.02	0.14	0.19	0.24
5300	0.52	0.77	1.06	1.39	1.74	1.91	2.11	2.49	2.83	3.18	0.02	0.14	0.20	0.24
5400	0.52	0.78	1.07	1.40	1.76	1.93	2.13	2.51	2.84	3.19	0.02	0.14	0.20	0.25
5500	0.52	0.78	1.08	1.41	1.77	1.94	2.15	2.52	2.86	3.20	0.02	0.14	0.21	0.25
5600	0.52	0.78	1.09	1.42	1.78	1.96	2.16	2.54	2.87	3.21	0.02	0.15	0.21	0.26
5800	0.52	0.79	1.10	1.44	1.81	1.98	2.19	2.56	2.89	3.22	0.02	0.15	0.22	0.27
6000	0.52	0.79	1.11	1.46	1.83	2.00	2.21	2.59	2.91	3.22	0.02	0.16	0.22	0.28
6200	0.52	0.80	1.12	1.47	1.85	2.02	2.23	2.60	2.92	3.21	0.03	0.16	0.23	0.28
6400	0.51	0.80	1.13	1.49	1.86	2.04	2.25	2.61	2.92	3.20	0.03	0.17	0.24	0.29
6600	0.51	0.80	1.13	1.50	1.88	2.05	2.26	2.62	2.92	3.17	0.03	0.17	0.25	0.30
6800	0.51	0.80	1.14	1.50	1.89	2.06	2.27	2.62	2.91	3.14	0.03	0.18	0.25	0.31
7000	0.50	0.80	1.14	1.51	1.89	2.07	2.27	2.62	2.89	-	0.03	0.18	0.26	0.32
7200	0.49	0.80	1.14	1.52	1.90	2.07	2.27	2.61	2.86	-	0.03	0.19	0.27	0.33
7400	0.49	0.79	1.14	1.52	1.90	2.07	2.27	2.60	2.83	-	0.03	0.19	0.28	0.34
7600	0.48	0.79	1.14	1.52	1.90	2.07	2.26	2.58	2.79	-	0.03	0.20	0.28	0.35
7800	0.47	0.78	1.14	1.52	1.90	2.06	2.25	2.55	-	-	0.03	0.20	0.29	0.36
8000	0.46	0.78	1.13	1.51	1.89	2.05	2.24	2.52	-	-	0.03	0.21	0.30	0.37
8200	0.44	0.77	1.13	1.51	1.88	2.04	2.22	2.48	-	-	0.03	0.22	0.31	0.38
8400	0.43	0.76	1.12	1.50	1.86	2.02	2.19	2.44	-	-	0.03	0.22	0.31	0.39

 Belt speed is over 30 m/sec. to 35 m/sec. Please consult our sales company or Engineering Department.

 Belt speed is over 35 m/sec. to 40 m/sec. Please consult our sales company or Engineering Department.



ZX-Section Power Rating

Table 2-21

[kw]

small pulley pitch speed nd(rpm)	Basic power rating for small pulley pitch diameter : Ps											Additional power rating for speed ratio (Pa)			
	Small pulley pitch diameter dp (mm)											Speed ratio			
	40	45	50	56	63	71	75	80	90	100	112	1.01 to 1.05	1.06 to 1.26	1.27 to 1.57	1.57<
700	0.21	0.26	0.31	0.36	0.43	0.50	0.53	0.58	0.66	0.75	0.85	0.00	0.01	0.02	0.03
950	0.26	0.32	0.39	0.46	0.54	0.63	0.68	0.74	0.85	0.96	1.08	0.00	0.02	0.03	0.03
1450	0.35	0.44	0.52	0.63	0.74	0.88	0.94	1.02	1.18	1.33	1.50	0.00	0.03	0.04	0.05
2850	0.52	0.68	0.83	1.00	1.20	1.42	1.53	1.66	1.91	2.15	2.43	0.01	0.06	0.08	0.10
100	0.05	0.05	0.06	0.07	0.09	0.10	0.11	0.11	0.13	0.15	0.17	0.00	0.00	0.00	0.00
200	0.08	0.10	0.11	0.13	0.15	0.18	0.19	0.21	0.24	0.27	0.30	0.00	0.00	0.01	0.01
300	0.11	0.13	0.16	0.18	0.22	0.25	0.27	0.29	0.33	0.37	0.42	0.00	0.01	0.01	0.01
400	0.14	0.17	0.20	0.23	0.27	0.32	0.34	0.37	0.42	0.47	0.54	0.00	0.01	0.01	0.01
500	0.16	0.20	0.24	0.28	0.33	0.38	0.41	0.44	0.51	0.57	0.65	0.00	0.01	0.01	0.02
600	0.19	0.23	0.27	0.32	0.38	0.44	0.47	0.51	0.59	0.66	0.75	0.00	0.01	0.02	0.02
700	0.21	0.26	0.31	0.36	0.43	0.50	0.53	0.58	0.66	0.75	0.85	0.00	0.01	0.02	0.03
800	0.23	0.29	0.34	0.40	0.47	0.55	0.59	0.64	0.74	0.83	0.95	0.00	0.02	0.02	0.03
900	0.25	0.31	0.37	0.44	0.52	0.61	0.65	0.71	0.81	0.92	1.04	0.00	0.02	0.03	0.03
1000	0.27	0.34	0.40	0.48	0.56	0.66	0.71	0.77	0.88	1.00	1.13	0.00	0.02	0.03	0.04
1100	0.29	0.36	0.43	0.51	0.60	0.71	0.76	0.83	0.95	1.07	1.22	0.00	0.02	0.03	0.04
1200	0.31	0.38	0.46	0.55	0.65	0.76	0.81	0.88	1.02	1.15	1.30	0.00	0.03	0.04	0.04
1300	0.32	0.41	0.48	0.58	0.69	0.81	0.87	0.94	1.08	1.22	1.38	0.00	0.03	0.04	0.05
1400	0.34	0.43	0.51	0.61	0.73	0.85	0.92	0.99	1.14	1.29	1.47	0.00	0.03	0.04	0.05
1500	0.36	0.45	0.54	0.64	0.76	0.90	0.96	1.05	1.21	1.36	1.54	0.00	0.03	0.04	0.05
1600	0.37	0.47	0.56	0.67	0.80	0.94	1.01	1.10	1.27	1.43	1.62	0.01	0.03	0.05	0.06
1700	0.39	0.49	0.59	0.70	0.84	0.99	1.06	1.15	1.32	1.50	1.70	0.01	0.04	0.05	0.06
1800	0.40	0.51	0.61	0.73	0.87	1.03	1.10	1.20	1.38	1.56	1.77	0.01	0.04	0.05	0.07
1900	0.41	0.52	0.63	0.76	0.91	1.07	1.15	1.25	1.44	1.62	1.84	0.01	0.04	0.06	0.07
2000	0.43	0.54	0.66	0.79	0.94	1.11	1.19	1.29	1.49	1.69	1.91	0.01	0.04	0.06	0.07
2100	0.44	0.56	0.68	0.82	0.97	1.15	1.23	1.34	1.55	1.75	1.98	0.01	0.04	0.06	0.08
2200	0.45	0.58	0.70	0.84	1.01	1.19	1.28	1.39	1.60	1.80	2.04	0.01	0.05	0.07	0.08
2300	0.46	0.59	0.72	0.87	1.04	1.23	1.32	1.43	1.65	1.86	2.11	0.01	0.05	0.07	0.08
2400	0.47	0.61	0.74	0.89	1.07	1.26	1.36	1.47	1.70	1.92	2.17	0.01	0.05	0.07	0.09
2500	0.49	0.62	0.76	0.92	1.10	1.30	1.40	1.52	1.75	1.97	2.23	0.01	0.05	0.07	0.09
2600	0.50	0.64	0.78	0.94	1.13	1.33	1.43	1.56	1.80	2.02	2.29	0.01	0.05	0.08	0.09
2700	0.51	0.65	0.80	0.97	1.16	1.37	1.47	1.60	1.84	2.08	2.34	0.01	0.06	0.08	0.10
2800	0.52	0.67	0.82	0.99	1.19	1.40	1.51	1.64	1.89	2.13	2.40	0.01	0.06	0.08	0.10
2900	0.53	0.68	0.83	1.01	1.21	1.44	1.54	1.68	1.93	2.18	2.45	0.01	0.06	0.09	0.11
3000	0.54	0.70	0.85	1.03	1.24	1.47	1.58	1.71	1.97	2.22	2.50	0.01	0.06	0.09	0.11
3100	0.55	0.71	0.87	1.06	1.27	1.50	1.61	1.75	2.02	2.27	2.55	0.01	0.06	0.09	0.11
3200	0.55	0.72	0.89	1.08	1.29	1.53	1.65	1.79	2.06	2.31	2.60	0.01	0.07	0.09	0.12
3300	0.56	0.74	0.90	1.10	1.32	1.56	1.68	1.82	2.10	2.36	2.65	0.01	0.07	0.10	0.12
3400	0.57	0.75	0.92	1.12	1.34	1.59	1.71	1.86	2.13	2.40	2.70	0.01	0.07	0.10	0.12
3500	0.58	0.76	0.93	1.14	1.37	1.62	1.74	1.89	2.17	2.44	2.74	0.01	0.07	0.10	0.13
3600	0.59	0.77	0.95	1.16	1.39	1.65	1.77	1.92	2.21	2.48	2.78	0.01	0.08	0.11	0.13
3700	0.59	0.78	0.96	1.18	1.41	1.67	1.80	1.95	2.24	2.52	2.82	0.01	0.08	0.11	0.13
3800	0.60	0.79	0.98	1.19	1.44	1.70	1.83	1.98	2.28	2.55	2.86	0.01	0.08	0.11	0.14
3900	0.61	0.80	0.99	1.21	1.46	1.73	1.86	2.01	2.31	2.59	2.89	0.01	0.08	0.12	0.14
4000	0.61	0.81	1.01	1.23	1.48	1.75	1.88	2.04	2.34	2.62	2.93	0.01	0.08	0.12	0.15
4100	0.62	0.82	1.02	1.25	1.50	1.78	1.91	2.07	2.37	2.66	2.96	0.01	0.09	0.12	0.15
4200	0.63	0.83	1.03	1.26	1.52	1.80	1.93	2.10	2.40	2.69	2.99	0.01	0.09	0.12	0.15
4300	0.63	0.84	1.04	1.28	1.54	1.82	1.96	2.12	2.43	2.72	3.02	0.01	0.09	0.13	0.16
4400	0.64	0.85	1.06	1.29	1.56	1.85	1.98	2.15	2.46	2.74	3.05	0.01	0.09	0.13	0.16
4500	0.64	0.86	1.07	1.31	1.58	1.87	2.01	2.17	2.49	2.77	3.07	0.01	0.09	0.13	0.16
4600	0.65	0.87	1.08	1.32	1.60	1.89	2.03	2.20	2.51	2.80	3.09	0.01	0.10	0.14	0.17
4700	0.65	0.88	1.09	1.34	1.61	1.91	2.05	2.22	2.54	2.82	3.12	0.02	0.10	0.14	0.17
4800	0.66	0.88	1.10	1.35	1.63	1.93	2.07	2.24	2.56	2.84	3.13	0.02	0.10	0.14	0.17
4900	0.66	0.89	1.11	1.37	1.65	1.95	2.09	2.26	2.58	2.86	3.15	0.02	0.10	0.15	0.18
5000	0.67	0.90	1.12	1.38	1.66	1.97	2.11	2.28	2.60	2.88	3.17	0.02	0.10	0.15	0.18
5100	0.67	0.91	1.13	1.39	1.68	1.99	2.13	2.30	2.62	2.90	3.18	0.02	0.11	0.15	0.19
5200	0.67	0.91	1.14	1.40	1.69	2.00	2.15	2.32	2.64	2.91	3.19	0.02	0.11	0.15	0.19
5300	0.68	0.92	1.15	1.42	1.71	2.02	2.16	2.34	2.65	2.93	3.20	0.02	0.11	0.16	0.19
5400	0.68	0.92	1.16	1.43	1.72	2.03	2.18	2.35	2.67	2.94	3.21	0.02	0.11	0.16	0.20
5500	0.68	0.93	1.17	1.44	1.73	2.05	2.20	2.37	2.68	2.95	3.21	0.02	0.11	0.16	0.20
5600	0.69	0.94	1.18	1.45	1.75	2.06	2.21	2.38	2.70	2.96	3.21	0.02	0.12	0.17	0.20
5800	0.69	0.95	1.19	1.47	1.77	2.09	2.24	2.41	2.72	2.98	3.21	0.02	0.12	0.17	0.21
6000	0.69	0.96	1.20	1.49	1.79	2.11	2.26	2.43	2.74	2.98	3.20	0.02	0.13	0.18	0.22
6200	0.70	0.96	1.22	1.50	1.81	2.13	2.28	2.45	2.75	2.99	3.18	0.02	0.13	0.18	0.23
6400	0.70	0.97	1.23	1.52	1.83	2.15	2.30	2.47	2.76	2.98	3.15	0.02	0.13	0.19	0.23
6600	0.70	0.98	1.24	1.53	1.84	2.17	2.31	2.48	2.76	2.97	3.11	0.02	0.14	0.20	0.24
6800	0.70	0.98	1.24	1.54	1.86	2.18	2.32	2.48	2.76	2.95	3.06	0.02	0.14	0.20	0.25
7000	0.70	0.98	1.25	1.55	1.87	2.19	2.33	2.49	2.75	2.92	-	0.02	0.15	0.21	0.26
7200	0.70	0.99	1.26	1.56	1.87	2.19	2.33	2.49	2.73	2.88	-	0.02	0.15	0.21	0.26
7400	0.70	0.99	1.26	1.56	1.88	2.19	2.33	2.48	2.71	2.84	-	0.02	0.15	0.22	0.27
7600	0.69	0.99	1.26	1.57	1.88	2.19	2.33	2.47	2.68	2.79	-	0.02	0.16	0.23	0.28
7800	0.69	0.99	1.26	1.57	1.88	2.19	2.32	2.46	2.65	-	-	0.03	0.16	0.23	0.28
8000	0.68	0.99	1.26	1.57	1.88	2.18	2.31	2.44	2.61	-	-	0.03	0.17	0.24	0.29
8200	0.68	0.98	1.26	1.57	1.88	2.17	2.29	2.41	2.57	-	-	0.03	0.17	0.24	0.30
8400	0.67	0.98	1.26	1.56	1.87	2.16	2.27	2.39	2.52	-	-	0.03	0.18	0.25	0.31

Light blue background: Belt speed is over 30 m/sec. to 35 m/sec. Please consult our sales company or Engineering Department.

Dark blue background: Belt speed is over 35 m/sec. to 40 m/sec. Please consult our sales company or Engineering Department.



A/13-Section Power Rating

Table 2-22

[kw]

small pulley pitch speed nd(rpm)	Basic power rating for small pulley pitch diameter : Ps															Additional power rating for speed ratio (Pa)			
	Small pulley pitch diameter dp (mm)															Speed ratio			
	71	75	80	90	95	100	106	112	118	125	132	140	150	160	180	1.01 to 1.05	1.06 to 1.26	1.27 to 1.57	<1.57
700	0.51	0.61	0.73	0.96	1.08	1.20	1.34	1.48	1.62	1.78	1.94	2.12	2.34	2.56	3.00	0.01	0.08	0.12	0.15
950	0.62	0.75	0.91	1.22	1.37	1.53	1.71	1.89	2.07	2.28	2.49	2.72	3.02	3.30	3.87	0.02	0.11	0.16	0.20
1450	0.80	0.98	1.21	1.66	1.89	2.11	2.37	2.63	2.89	3.18	3.48	3.81	4.22	4.62	5.40	0.03	0.18	0.25	0.31
2850	1.04	1.36	1.75	2.52	2.90	3.27	3.70	4.12	4.53	4.99	5.44	5.93	6.51	7.06	8.04	0.05	0.34	0.49	0.60
100	0.12	0.13	0.16	0.20	0.22	0.24	0.26	0.28	0.31	0.33	0.36	0.39	0.43	0.47	0.55	0.00	0.01	0.02	0.02
200	0.20	0.24	0.27	0.35	0.39	0.43	0.47	0.52	0.56	0.61	0.66	0.72	0.80	0.87	1.01	0.00	0.02	0.03	0.04
300	0.28	0.32	0.38	0.49	0.54	0.60	0.66	0.73	0.79	0.87	0.94	1.03	1.13	1.24	1.45	0.01	0.04	0.05	0.06
400	0.34	0.40	0.47	0.62	0.69	0.76	0.85	0.93	1.01	1.11	1.21	1.32	1.45	1.59	1.86	0.01	0.05	0.07	0.08
500	0.40	0.48	0.56	0.74	0.83	0.91	1.02	1.12	1.22	1.34	1.46	1.59	1.76	1.93	2.25	0.01	0.06	0.09	0.11
600	0.46	0.54	0.65	0.86	0.96	1.06	1.18	1.30	1.42	1.56	1.70	1.86	2.06	2.25	2.63	0.01	0.07	0.10	0.13
700	0.51	0.61	0.73	0.96	1.08	1.20	1.34	1.48	1.62	1.78	1.94	2.12	2.34	2.56	3.00	0.01	0.08	0.12	0.15
800	0.56	0.67	0.80	1.07	1.20	1.33	1.49	1.65	1.80	1.98	2.16	2.37	2.62	2.87	3.36	0.01	0.10	0.14	0.17
900	0.60	0.72	0.87	1.17	1.32	1.46	1.64	1.81	1.99	2.18	2.38	2.61	2.88	3.16	3.70	0.02	0.11	0.15	0.19
1000	0.64	0.78	0.94	1.27	1.43	1.59	1.78	1.97	2.16	2.38	2.60	2.84	3.14	3.44	4.03	0.02	0.12	0.17	0.21
1100	0.68	0.83	1.01	1.36	1.54	1.71	1.92	2.13	2.33	2.57	2.80	3.07	3.40	3.72	4.36	0.02	0.13	0.19	0.23
1200	0.72	0.87	1.07	1.45	1.64	1.83	2.05	2.28	2.50	2.75	3.00	3.29	3.64	3.99	4.67	0.02	0.15	0.21	0.25
1300	0.75	0.92	1.13	1.54	1.74	1.94	2.18	2.42	2.66	2.93	3.20	3.50	3.88	4.25	4.97	0.02	0.16	0.22	0.27
1400	0.78	0.96	1.19	1.62	1.84	2.05	2.31	2.56	2.81	3.10	3.39	3.71	4.11	4.50	5.26	0.03	0.17	0.24	0.30
1500	0.81	1.00	1.24	1.70	1.93	2.16	2.43	2.70	2.96	3.27	3.57	3.91	4.33	4.74	5.54	0.03	0.18	0.26	0.32
1600	0.84	1.04	1.29	1.78	2.02	2.26	2.55	2.83	3.11	3.43	3.75	4.10	4.54	4.97	5.80	0.03	0.19	0.27	0.34
1700	0.87	1.08	1.34	1.86	2.11	2.36	2.66	2.96	3.25	3.59	3.92	4.29	4.75	5.19	6.06	0.03	0.21	0.29	0.36
1800	0.89	1.11	1.39	1.93	2.20	2.46	2.77	3.08	3.39	3.74	4.08	4.47	4.95	5.41	6.30	0.03	0.22	0.31	0.38
1900	0.91	1.15	1.43	2.00	2.28	2.55	2.88	3.20	3.52	3.88	4.24	4.64	5.14	5.61	6.53	0.04	0.23	0.33	0.40
2000	0.93	1.18	1.48	2.07	2.36	2.64	2.98	3.32	3.64	4.02	4.39	4.81	5.32	5.81	6.75	0.04	0.24	0.34	0.42
2100	0.95	1.20	1.52	2.13	2.43	2.73	3.08	3.43	3.77	4.16	4.54	4.97	5.49	6.00	6.95	0.04	0.25	0.36	0.44
2200	0.97	1.23	1.56	2.19	2.50	2.81	3.18	3.53	3.89	4.29	4.68	5.12	5.66	6.17	7.15	0.04	0.27	0.38	0.46
2300	0.98	1.26	1.59	2.25	2.57	2.89	3.27	3.64	4.00	4.41	4.82	5.27	5.81	6.34	7.32	0.04	0.28	0.39	0.49
2400	1.00	1.28	1.63	2.31	2.64	2.97	3.35	3.73	4.11	4.53	4.95	5.41	5.96	6.50	7.49	0.04	0.29	0.41	0.51
2500	1.01	1.30	1.66	2.36	2.70	3.04	3.44	3.83	4.21	4.64	5.07	5.54	6.10	6.64	7.64	0.05	0.30	0.43	0.53
2600	1.02	1.32	1.69	2.41	2.76	3.11	3.52	3.92	4.31	4.75	5.18	5.66	6.23	6.78	7.77	0.05	0.31	0.45	0.55
2700	1.03	1.34	1.72	2.46	2.82	3.17	3.59	4.00	4.40	4.85	5.29	5.77	6.35	6.90	7.89	0.05	0.33	0.46	0.57
2800	1.03	1.35	1.74	2.50	2.87	3.24	3.66	4.08	4.49	4.95	5.39	5.88	6.46	7.01	8.00	0.05	0.34	0.48	0.59
2900	1.04	1.36	1.77	2.54	2.92	3.30	3.73	4.16	4.57	5.04	5.49	5.98	6.56	7.11	8.08	0.05	0.35	0.50	0.61
3000	1.04	1.38	1.79	2.58	2.97	3.35	3.79	4.23	4.65	5.12	5.57	6.07	6.65	7.20	8.15	0.06	0.36	0.51	0.63
3100	1.04	1.39	1.81	2.62	3.02	3.40	3.85	4.29	4.72	5.19	5.65	6.15	6.74	7.27	8.21	0.06	0.37	0.53	0.65
3200	1.04	1.39	1.82	2.65	3.06	3.45	3.91	4.35	4.78	5.26	5.72	6.22	6.81	7.34	8.25	0.06	0.39	0.55	0.68
3300	1.04	1.40	1.84	2.69	3.09	3.49	3.96	4.41	4.84	5.33	5.79	6.29	6.86	7.39	8.26	0.06	0.40	0.57	0.70
3400	1.04	1.40	1.85	2.71	3.13	3.53	4.00	4.46	4.90	5.38	5.85	6.34	6.91	7.42	8.26	0.06	0.41	0.58	0.72
3500	1.03	1.40	1.86	2.74	3.16	3.57	4.05	4.50	4.94	5.43	5.89	6.39	6.95	7.45	8.25	0.07	0.42	0.60	0.74
3600	1.02	1.40	1.87	2.76	3.19	3.60	4.08	4.54	4.99	5.47	5.93	6.42	6.97	7.46	8.21	0.07	0.44	0.62	0.76
3700	1.02	1.40	1.87	2.78	3.21	3.63	4.11	4.58	5.02	5.51	5.97	6.45	6.99	7.45	8.15	0.07	0.45	0.64	0.78
3800	1.01	1.40	1.88	2.79	3.23	3.65	4.14	4.61	5.05	5.54	5.99	6.46	6.99	7.44	8.07	0.07	0.46	0.65	0.80
3900	0.99	1.39	1.88	2.81	3.25	3.67	4.16	4.63	5.07	5.56	6.00	6.47	6.98	7.40	7.98	0.07	0.47	0.67	0.82
4000	0.98	1.38	1.88	2.81	3.26	3.69	4.18	4.65	5.09	5.57	6.01	6.46	6.95	7.35	7.86	0.07	0.48	0.69	0.84
4100	0.96	1.37	1.87	2.82	3.27	3.70	4.20	4.66	5.10	5.57	6.01	6.45	6.92	7.29	7.72	0.08	0.50	0.70	0.87
4200	0.94	1.36	1.87	2.82	3.28	3.71	4.20	4.67	5.10	5.57	6.00	6.42	6.87	7.21	7.55	0.08	0.51	0.72	0.89
4300	0.92	1.35	1.86	2.82	3.28	3.71	4.21	4.67	5.10	5.56	5.97	6.39	6.81	7.11	-	0.08	0.52	0.74	0.91
4400	0.90	1.33	1.84	2.82	3.27	3.71	4.20	4.66	5.09	5.54	5.94	6.34	6.73	7.00	-	0.08	0.53	0.76	0.93
4500	0.88	1.31	1.83	2.81	3.27	3.70	4.20	4.65	5.07	5.51	5.90	6.28	6.64	6.87	-	0.08	0.54	0.77	0.95
4600	0.85	1.29	1.81	2.80	3.26	3.69	4.18	4.63	5.05	5.48	5.85	6.21	6.53	6.73	-	0.09	0.56	0.79	0.97
4700	0.83	1.27	1.80	2.79	3.24	3.68	4.16	4.61	5.01	5.43	5.79	6.12	6.42	6.56	-	0.09	0.57	0.81	0.99
4800	0.80	1.24	1.77	2.77	3.23	3.66	4.14	4.58	4.98	5.38	5.72	6.03	6.28	-	-	0.09	0.58	0.82	1.01
4900	0.77	1.21	1.75	2.75	3.20	3.63	4.11	4.54	4.93	5.32	5.64	5.92	6.13	-	-	0.09	0.59	0.84	1.03
5000	0.73	1.18	1.72	2.72	3.18	3.60	4.07	4.50	4.87	5.25	5.55	5.80	5.97	-	-	0.09	0.60	0.86	1.06
5100	0.70	1.15	1.69	2.69	3.15	3.57	4.03	4.45	4.81	5.17	5.45	5.67	-	-	-	0.10	0.62	0.88	1.08
5200	0.66	1.12	1.66	2.66	3.11	3.53	3.98	4.39	4.74	5.08	5.33	5.52	-	-	-	0.10	0.63	0.89	1.10
5300	0.62	1.08	1.62	2.62	3.07	3.48	3.93	4.32	4.66	4.98	5.21	5.36	-	-	-	0.10	0.64	0.91	1.12
5400	0.58	1.04	1.59	2.58	3.03	3.43	3.87	4.25	4.57	4.87	5.07	5.19	-	-	-	0.10	0.65	0.93	1.14
5500	0.54	1.00	1.55	2.54	2.98	3.38	3.81	4.17	4.48	4.75	4.93	-	-	-	-	0.10	0.67	0.94	1.16
5600	0.49	0.95	1.50	2.49	2.92	3.32	3.73	4.09	4.37	4.62	4.77	-	-	-	-	0.10	0.68	0.96	1.18
5800	0.39	0.86	1.41	2.38	2.80	3.18	3.57	3.89	4.14	4.33	-	-	-	-	-	0.11	0.70	1.00	1.22
6000	0.29	0.75	1.30	2.25	2.66	3.02	3.38	3.67	3.87	4.00	-	-	-	-	-	0.11	0.73	1.03	1.27

 Belt speed is over 30 m/sec. to 35 m/sec. Please consult our sales company or Engineering Department.

 Belt speed is over 35 m/sec. to 40 m/sec. Please consult our sales company or Engineering Department.



AX-Section Power Rating

Table 2-23

[kw]

small pulley pitch speed (rpm)	Basic power rating for small pulley pitch diameter : Ps															Additional power rating for speed ratio (Pa)			
	Small pulley pitch diameter dp (mm)															Speed ratio			
	63	71	80	90	95	100	106	112	118	125	132	140	150	160	180	1.01 to 1.05	1.06 to 1.26	1.27 to 1.57	<1.57
700	0.68	0.86	1.07	1.29	1.40	1.51	1.64	1.77	1.90	2.05	2.19	2.36	2.56	2.76	3.16	0.01	0.06	0.09	0.11
950	0.82	1.06	1.33	1.62	1.76	1.90	2.07	2.23	2.39	2.58	2.77	2.98	3.24	3.49	3.99	0.01	0.09	0.12	0.15
1450	1.05	1.39	1.76	2.17	2.37	2.56	2.80	3.03	3.25	3.51	3.77	4.05	4.41	4.75	5.42	0.02	0.13	0.19	0.23
2850	1.39	1.96	2.58	3.24	3.56	3.87	4.23	4.59	4.93	5.32	5.69	6.10	6.59	7.04	7.85	0.04	0.26	0.37	0.45
100	0.16	0.19	0.23	0.28	0.30	0.32	0.34	0.37	0.39	0.42	0.45	0.48	0.52	0.56	0.64	0.00	0.01	0.01	0.02
200	0.28	0.34	0.41	0.49	0.52	0.56	0.61	0.65	0.70	0.75	0.80	0.86	0.93	1.00	1.14	0.00	0.02	0.03	0.03
300	0.37	0.46	0.56	0.67	0.73	0.78	0.85	0.91	0.97	1.04	1.12	1.20	1.30	1.40	1.60	0.00	0.03	0.04	0.05
400	0.46	0.58	0.70	0.84	0.91	0.98	1.06	1.14	1.22	1.32	1.41	1.51	1.64	1.77	2.02	0.01	0.04	0.05	0.06
500	0.54	0.68	0.83	1.00	1.09	1.17	1.27	1.36	1.46	1.57	1.68	1.81	1.96	2.12	2.42	0.01	0.05	0.06	0.08
600	0.61	0.77	0.95	1.15	1.25	1.35	1.46	1.57	1.69	1.82	1.94	2.09	2.27	2.45	2.80	0.01	0.05	0.08	0.10
700	0.68	0.86	1.07	1.29	1.40	1.51	1.64	1.77	1.90	2.05	2.19	2.36	2.56	2.76	3.16	0.01	0.06	0.09	0.11
800	0.74	0.95	1.18	1.43	1.55	1.67	1.82	1.96	2.10	2.27	2.43	2.61	2.84	3.06	3.50	0.01	0.07	0.10	0.13
900	0.79	1.02	1.28	1.55	1.69	1.83	1.98	2.14	2.30	2.48	2.66	2.86	3.11	3.35	3.83	0.01	0.08	0.12	0.14
1000	0.85	1.10	1.38	1.68	1.82	1.97	2.15	2.32	2.49	2.68	2.88	3.10	3.36	3.63	4.15	0.01	0.09	0.13	0.16
1100	0.90	1.17	1.47	1.79	1.95	2.11	2.30	2.49	2.67	2.88	3.09	3.32	3.61	3.90	4.45	0.02	0.10	0.14	0.18
1200	0.94	1.24	1.56	1.91	2.08	2.25	2.45	2.65	2.84	3.07	3.29	3.54	3.85	4.15	4.74	0.02	0.11	0.16	0.19
1300	0.99	1.30	1.64	2.01	2.20	2.38	2.59	2.80	3.01	3.25	3.49	3.75	4.08	4.40	5.02	0.02	0.12	0.17	0.21
1400	1.03	1.36	1.72	2.12	2.31	2.50	2.73	2.95	3.17	3.43	3.68	3.96	4.30	4.64	5.29	0.02	0.13	0.18	0.22
1500	1.07	1.42	1.80	2.22	2.42	2.62	2.86	3.10	3.33	3.60	3.86	4.15	4.51	4.86	5.54	0.02	0.14	0.19	0.24
1600	1.11	1.47	1.88	2.31	2.53	2.74	2.99	3.24	3.48	3.76	4.03	4.34	4.72	5.08	5.79	0.02	0.15	0.21	0.25
1700	1.14	1.53	1.95	2.41	2.63	2.85	3.11	3.37	3.62	3.92	4.20	4.52	4.91	5.29	6.02	0.02	0.15	0.22	0.27
1800	1.17	1.58	2.02	2.50	2.73	2.96	3.23	3.50	3.76	4.07	4.36	4.69	5.10	5.49	6.24	0.03	0.16	0.23	0.29
1900	1.20	1.62	2.08	2.58	2.82	3.06	3.35	3.63	3.90	4.21	4.52	4.86	5.28	5.68	6.45	0.03	0.17	0.25	0.30
2000	1.23	1.67	2.15	2.66	2.92	3.17	3.46	3.75	4.03	4.35	4.67	5.02	5.45	5.86	6.65	0.03	0.18	0.26	0.32
2100	1.25	1.71	2.21	2.74	3.00	3.26	3.56	3.86	4.15	4.49	4.81	5.17	5.61	6.04	6.84	0.03	0.19	0.27	0.33
2200	1.28	1.75	2.27	2.82	3.09	3.35	3.67	3.97	4.27	4.62	4.95	5.32	5.77	6.20	7.01	0.03	0.20	0.28	0.35
2300	1.30	1.79	2.32	2.89	3.17	3.44	3.77	4.08	4.39	4.74	5.08	5.46	5.92	6.36	7.18	0.03	0.21	0.30	0.37
2400	1.32	1.82	2.37	2.96	3.25	3.53	3.86	4.18	4.50	4.86	5.21	5.59	6.06	6.50	7.33	0.03	0.22	0.31	0.38
2500	1.34	1.86	2.42	3.03	3.32	3.61	3.95	4.28	4.60	4.97	5.33	5.72	6.19	6.64	7.46	0.04	0.23	0.32	0.40
2600	1.36	1.89	2.47	3.09	3.39	3.69	4.04	4.37	4.70	5.08	5.44	5.84	6.31	6.76	7.59	0.04	0.24	0.34	0.41
2700	1.37	1.92	2.52	3.15	3.46	3.76	4.12	4.46	4.80	5.18	5.54	5.95	6.43	6.88	7.70	0.04	0.25	0.35	0.43
2800	1.39	1.95	2.56	3.21	3.53	3.84	4.20	4.55	4.89	5.27	5.64	6.05	6.54	6.99	7.80	0.04	0.26	0.36	0.45
2900	1.40	1.98	2.60	3.27	3.59	3.90	4.27	4.63	4.97	5.36	5.74	6.15	6.63	7.09	7.89	0.04	0.26	0.38	0.46
3000	1.41	2.00	2.64	3.32	3.65	3.97	4.34	4.70	5.05	5.45	5.83	6.24	6.72	7.17	7.97	0.04	0.27	0.39	0.48
3100	1.42	2.02	2.68	3.37	3.70	4.03	4.41	4.77	5.13	5.53	5.91	6.32	6.80	7.25	8.03	0.04	0.28	0.40	0.49
3200	1.43	2.04	2.71	3.42	3.75	4.09	4.47	4.84	5.20	5.60	5.98	6.40	6.88	7.32	8.07	0.05	0.29	0.41	0.51
3300	1.43	2.06	2.74	3.46	3.80	4.14	4.53	4.90	5.26	5.67	6.05	6.46	6.94	7.37	8.11	0.05	0.30	0.43	0.53
3400	1.44	2.08	2.77	3.50	3.85	4.19	4.58	4.96	5.32	5.73	6.11	6.52	7.00	7.42	8.12	0.05	0.31	0.44	0.54
3500	1.44	2.09	2.80	3.54	3.89	4.24	4.63	5.01	5.38	5.78	6.17	6.57	7.04	7.46	8.13	0.05	0.32	0.45	0.56
3600	1.44	2.11	2.82	3.57	3.93	4.28	4.68	5.06	5.43	5.83	6.21	6.62	7.08	7.48	8.11	0.05	0.33	0.47	0.57
3700	1.44	2.12	2.84	3.61	3.97	4.32	4.72	5.11	5.47	5.88	6.26	6.65	7.10	7.49	8.09	0.05	0.34	0.48	0.59
3800	1.44	2.13	2.87	3.64	4.00	4.35	4.76	5.15	5.51	5.91	6.29	6.68	7.12	7.49	8.05	0.05	0.35	0.49	0.60
3900	1.44	2.14	2.88	3.66	4.03	4.39	4.79	5.18	5.55	5.95	6.32	6.70	7.13	7.48	7.99	0.05	0.36	0.50	0.62
4000	1.43	2.14	2.90	3.69	4.06	4.41	4.82	5.21	5.57	5.97	6.34	6.71	7.12	7.46	7.91	0.06	0.36	0.52	0.64
4100	1.43	2.15	2.91	3.71	4.08	4.44	4.85	5.23	5.60	5.99	6.35	6.72	7.11	7.43	7.82	0.06	0.37	0.53	0.65
4200	1.42	2.15	2.92	3.72	4.10	4.46	4.87	5.25	5.61	6.00	6.35	6.71	7.09	7.38	7.72	0.06	0.38	0.54	0.67
4300	1.41	2.15	2.93	3.74	4.12	4.48	4.89	5.27	5.63	6.01	6.35	6.70	7.05	7.33	-	0.06	0.39	0.56	0.68
4400	1.40	2.15	2.94	3.75	4.13	4.49	4.90	5.28	5.63	6.01	6.34	6.68	7.01	7.25	-	0.06	0.40	0.57	0.70
4500	1.39	2.15	2.94	3.76	4.14	4.50	4.91	5.28	5.63	6.00	6.33	6.64	6.96	7.17	-	0.06	0.41	0.58	0.72
4600	1.38	2.14	2.95	3.77	4.15	4.51	4.91	5.28	5.63	5.99	6.30	6.60	6.89	7.08	-	0.06	0.42	0.60	0.73
4700	1.36	2.14	2.95	3.77	4.15	4.51	4.91	5.28	5.62	5.97	6.27	6.55	6.81	6.97	-	0.07	0.43	0.61	0.75
4800	1.35	2.13	2.94	3.77	4.15	4.50	4.90	5.27	5.60	5.94	6.23	6.49	6.73	-	-	0.07	0.44	0.62	0.76
4900	1.33	2.12	2.94	3.76	4.14	4.50	4.89	5.25	5.57	5.90	6.18	6.43	6.63	-	-	0.07	0.45	0.63	0.78
5000	1.31	2.11	2.93	3.76	4.14	4.49	4.88	5.23	5.55	5.86	6.12	6.35	6.52	-	-	0.07	0.46	0.65	0.80
5100	1.29	2.09	2.92	3.75	4.12	4.47	4.86	5.20	5.51	5.81	6.06	6.26	-	-	-	0.07	0.46	0.66	0.81
5200	1.27	2.08	2.91	3.74	4.11	4.46	4.84	5.17	5.47	5.76	5.98	6.16	-	-	-	0.07	0.47	0.67	0.83
5300	1.25	2.06	2.89	3.72	4.09	4.43	4.81	5.14	5.42	5.69	5.90	6.05	-	-	-	0.07	0.48	0.69	0.84
5400	1.23	2.04	2.88	3.70	4.07	4.41	4.77	5.09	5.37	5.62	5.81	5.94	-	-	-	0.08	0.49	0.70	0.86
5500	1.20	2.02	2.86	3.68	4.04	4.38	4.73	5.04	5.30	5.54	5.71	-	-	-	-	0.08	0.50	0.71	0.88
5600	1.18	2.00	2.84	3.65	4.01	4.34	4.69	4.99	5.24	5.46	5.60	-	-	-	-	0.08	0.51	0.72	0.89
5700	1.15	1.97	2.81	3.62	3.98	4.30	4.64	4.93	5.16	5.36	5.48	-	-	-	-	0.08	0.52	0.74	0.91
5800	1.12	1.95	2.79	3.59	3.94	4.26	4.59	4.86	5.08	5.26	-	-	-	-	-	0.08	0.53	0.75	0.92
5900	1.09	1.92	2.76	3.56	3.90	4.21	4.53	4.79	4.99	5.15	-	-	-	-	-	0.08	0.54	0.76	0.94
6000	1.05	1.89	2.73	3.52	3.86	4.16	4.47	4.71	4.90	5.03	-	-	-	-	-	0.08	0.55	0.78	0.95

 Belt speed is over 30 m/sec. to 35 m/sec. Please consult our sales company or Engineering Department.
 Belt speed is over 35 m/sec. to 40 m/sec. Please consult our sales company or Engineering Department.

2

Design

B/17-Section Power Rating

Table 2-24

[kw]

small pulley pitch speed nd(rpm)	Basic power rating for small pulley pitch diameter : Ps															Additional power rating for speed ratio (Pa)			
	Small pulley pitch diameter dp (mm)															Speed ratio			
	112	125	132	140	150	160	170	180	190	200	212	224	236	250	280	1.01 to 1.05	1.06 to 1.26	1.27 to 1.57	1.57<
700	1.48	1.96	2.21	2.49	2.85	3.20	3.55	3.89	4.24	4.58	4.98	5.38	5.78	6.23	7.20	0.03	0.19	0.27	0.33
950	1.83	2.45	2.78	3.15	3.61	4.06	4.51	4.96	5.40	5.84	6.35	6.86	7.37	7.94	9.15	0.04	0.25	0.36	0.44
1450	2.38	3.26	3.72	4.25	4.89	5.53	6.15	6.76	7.36	7.95	8.64	9.32	9.97	10.71	12.21	0.06	0.39	0.55	0.68
2850	3.01	4.39	5.10	5.88	6.81	7.68	8.49	9.24	9.92	10.54	11.19	11.74	12.17	12.54	-	0.12	0.76	1.08	1.33
100	0.33	0.41	0.45	0.50	0.56	0.62	0.69	0.75	0.81	0.87	0.94	1.01	1.08	1.16	1.34	0.00	0.03	0.04	0.05
200	0.57	0.73	0.81	0.90	1.02	1.13	1.25	1.36	1.47	1.59	1.72	1.85	1.99	2.14	2.47	0.01	0.05	0.08	0.09
300	0.79	1.01	1.13	1.26	1.43	1.60	1.76	1.92	2.09	2.25	2.44	2.63	2.83	3.05	3.52	0.01	0.08	0.11	0.14
400	0.98	1.27	1.42	1.60	1.81	2.03	2.24	2.45	2.66	2.87	3.12	3.37	3.62	3.90	4.51	0.02	0.11	0.15	0.19
500	1.16	1.51	1.70	1.91	2.18	2.44	2.70	2.96	3.21	3.47	3.77	4.07	4.37	4.72	5.45	0.02	0.13	0.19	0.23
600	1.33	1.74	1.96	2.21	2.52	2.83	3.13	3.44	3.74	4.03	4.39	4.74	5.09	5.49	6.34	0.02	0.16	0.23	0.28
700	1.48	1.96	2.21	2.49	2.85	3.20	3.55	3.89	4.24	4.58	4.98	5.38	5.78	6.23	7.20	0.03	0.19	0.27	0.33
800	1.63	2.16	2.44	2.76	3.16	3.56	3.95	4.33	4.72	5.10	5.55	5.99	6.43	6.94	8.01	0.03	0.21	0.30	0.37
900	1.77	2.35	2.67	3.02	3.46	3.90	4.33	4.76	5.18	5.60	6.09	6.58	7.06	7.62	8.78	0.04	0.24	0.34	0.42
1000	1.89	2.54	2.88	3.27	3.75	4.23	4.70	5.16	5.62	6.07	6.61	7.14	7.66	8.26	9.51	0.04	0.27	0.38	0.47
1100	2.01	2.71	3.09	3.51	4.03	4.54	5.05	5.55	6.04	6.53	7.10	7.67	8.23	8.87	10.19	0.05	0.29	0.42	0.51
1200	2.13	2.88	3.28	3.73	4.29	4.84	5.38	5.92	6.44	6.96	7.58	8.18	8.77	9.44	10.83	0.05	0.32	0.46	0.56
1300	2.23	3.04	3.46	3.95	4.54	5.12	5.70	6.27	6.83	7.38	8.02	8.65	9.27	9.98	11.42	0.05	0.35	0.49	0.61
1400	2.33	3.19	3.64	4.15	4.78	5.40	6.01	6.60	7.19	7.77	8.44	9.10	9.75	10.48	11.96	0.06	0.37	0.53	0.65
1500	2.42	3.33	3.80	4.34	5.01	5.66	6.29	6.92	7.53	8.13	8.84	9.52	10.19	10.94	12.45	0.06	0.40	0.57	0.70
1600	2.51	3.46	3.96	4.53	5.22	5.90	6.57	7.22	7.86	8.48	9.21	9.91	10.59	11.36	12.88	0.07	0.43	0.61	0.75
1700	2.59	3.58	4.11	4.70	5.42	6.13	6.82	7.50	8.16	8.80	9.55	10.27	10.96	11.74	13.26	0.07	0.46	0.65	0.79
1800	2.66	3.70	4.25	4.86	5.61	6.35	7.07	7.76	8.44	9.10	9.86	10.59	11.30	12.07	13.58	0.07	0.48	0.68	0.84
1900	2.73	3.81	4.38	5.01	5.79	6.55	7.29	8.01	8.70	9.37	10.15	10.89	11.59	12.36	13.84	0.08	0.51	0.72	0.89
2000	2.78	3.91	4.49	5.15	5.96	6.74	7.50	8.23	8.94	9.62	10.40	11.14	11.84	12.61	14.04	0.08	0.54	0.76	0.93
2100	2.84	4.00	4.60	5.28	6.11	6.91	7.68	8.43	9.15	9.84	10.62	11.36	12.06	12.80	14.16	0.09	0.56	0.80	0.98
2200	2.88	4.08	4.70	5.40	6.25	7.07	7.85	8.61	9.34	10.03	10.81	11.54	12.22	12.95	14.22	0.09	0.59	0.84	1.03
2300	2.92	4.15	4.79	5.51	6.37	7.21	8.01	8.77	9.50	10.19	10.97	11.69	12.35	13.04	14.21	0.10	0.62	0.87	1.07
2400	2.95	4.22	4.87	5.60	6.49	7.33	8.14	8.91	9.64	10.33	11.09	11.79	12.43	13.08	14.13	0.10	0.64	0.91	1.12
2500	2.98	4.27	4.94	5.69	6.58	7.44	8.25	9.02	9.75	10.43	11.18	11.86	12.46	13.06	13.96	0.10	0.67	0.95	1.17
2600	2.99	4.32	5.00	5.76	6.67	7.53	8.35	9.12	9.84	10.50	11.23	11.88	12.44	12.99	13.72	0.11	0.70	0.99	1.21
2700	3.00	4.35	5.05	5.82	6.73	7.60	8.42	9.18	9.89	10.54	11.24	11.86	12.37	12.85	13.40	0.11	0.72	1.03	1.26
2800	3.01	4.38	5.09	5.86	6.79	7.66	8.47	9.23	9.92	10.55	11.22	11.79	12.25	12.66	-	0.12	0.75	1.06	1.31
2900	3.00	4.40	5.11	5.90	6.83	7.69	8.50	9.24	9.92	10.53	11.16	11.67	12.08	12.40	-	0.12	0.78	1.10	1.36
3000	2.99	4.41	5.13	5.92	6.85	7.71	8.51	9.24	9.89	10.47	11.05	11.51	11.85	12.07	-	0.12	0.80	1.14	1.40
3100	2.97	4.40	5.13	5.92	6.85	7.71	8.50	9.20	9.83	10.37	10.90	11.30	11.56	-	-	0.13	0.83	1.18	1.45
3200	2.94	4.39	5.12	5.92	6.84	7.69	8.46	9.14	9.73	10.24	10.71	11.04	11.22	-	-	0.13	0.86	1.22	1.50
3300	2.91	4.37	5.10	5.89	6.81	7.65	8.40	9.05	9.61	10.07	10.48	10.73	-	-	-	0.14	0.88	1.25	1.54
3400	2.87	4.33	5.07	5.86	6.77	7.59	8.31	8.93	9.45	9.86	10.20	10.36	-	-	-	0.14	0.91	1.29	1.59
3500	2.82	4.29	5.02	5.81	6.71	7.50	8.20	8.78	9.26	9.61	9.87	-	-	-	-	0.14	0.94	1.33	1.64
3600	2.76	4.23	4.97	5.74	6.62	7.40	8.06	8.61	9.03	9.32	9.49	-	-	-	-	0.15	0.96	1.37	1.68
3700	2.69	4.17	4.89	5.66	6.52	7.27	7.90	8.40	8.76	8.99	-	-	-	-	-	0.15	0.99	1.41	1.73
3800	2.61	4.09	4.81	5.57	6.41	7.12	7.71	8.16	8.46	8.62	-	-	-	-	-	0.16	1.02	1.44	1.78
3900	2.53	4.00	4.71	5.45	6.27	6.95	7.49	7.88	8.12	-	-	-	-	-	-	0.16	1.04	1.48	1.82
4000	2.43	3.90	4.60	5.33	6.11	6.75	7.24	7.58	7.74	-	-	-	-	-	-	0.17	1.07	1.52	1.87
4100	2.33	3.78	4.47	5.18	5.93	6.53	6.97	7.24	-	-	-	-	-	-	-	0.17	1.10	1.56	1.92
4200	2.22	3.66	4.33	5.02	5.73	6.29	6.67	6.86	-	-	-	-	-	-	-	0.17	1.12	1.60	1.96
4300	2.10	3.52	4.18	4.84	5.52	6.02	6.33	-	-	-	-	-	-	-	-	0.18	1.15	1.63	2.01
4400	1.96	3.37	4.01	4.64	5.28	5.72	5.97	-	-	-	-	-	-	-	-	0.18	1.18	1.67	2.06
4500	1.82	3.20	3.82	4.43	5.01	5.40	-	-	-	-	-	-	-	-	-	0.19	1.20	1.71	2.10
4600	1.67	3.02	3.62	4.20	4.73	5.05	-	-	-	-	-	-	-	-	-	0.19	1.23	1.75	2.15
4700	1.51	2.83	3.41	3.94	4.42	4.68	-	-	-	-	-	-	-	-	-	0.19	1.26	1.79	2.20
4800	1.34	2.63	3.18	3.67	4.09	-	-	-	-	-	-	-	-	-	-	0.20	1.28	1.82	2.24
4900	1.16	2.41	2.93	3.39	3.74	-	-	-	-	-	-	-	-	-	-	0.20	1.31	1.86	2.29
5000	0.97	2.17	2.66	3.08	3.36	-	-	-	-	-	-	-	-	-	-	0.21	1.34	1.90	2.34

 Belt speed is over 30 m/sec. to 35 m/sec. Please consult our sales company or Engineering Department.

 Belt speed is over 35 m/sec. to 40 m/sec. Please consult our sales company or Engineering Department.



BX-Section Power Rating

Table 2-25

[kw]

small pulley pitch speed nd(rpm)	Basic power rating for small pulley pitch diameter : Ps																Additional power rating for speed ratio (Pa)			
	Small pulley pitch diameter dp (mm)																Speed ratio			
	90	100	106	112	118	125	132	140	160	180	190	200	212	224	250	280	1.01 to 1.05	1.06 to 1.26	1.27 to 1.57	<1.57
700	1.70	2.01	2.20	2.38	2.56	2.77	2.98	3.22	3.79	4.36	4.63	4.91	5.23	5.55	6.23	6.99	0.02	0.10	0.14	0.17
950	2.12	2.52	2.76	3.00	3.23	3.50	3.76	4.07	4.80	5.51	5.86	6.21	6.62	7.02	7.86	8.80	0.02	0.13	0.19	0.23
1450	2.83	3.39	3.73	4.06	4.38	4.75	5.12	5.53	6.54	7.50	7.96	8.42	8.95	9.46	10.53	11.68	0.03	0.20	0.29	0.35
2850	4.16	5.07	5.60	6.11	6.61	7.17	7.72	8.31	9.68	10.88	11.41	11.89	12.40	12.84	13.53	-	0.06	0.40	0.57	0.70
100	0.37	0.43	0.46	0.49	0.53	0.57	0.61	0.65	0.76	0.87	0.93	0.98	1.04	1.11	1.24	1.40	0.00	0.01	0.02	0.02
200	0.65	0.75	0.82	0.88	0.94	1.02	1.09	1.17	1.37	1.57	1.67	1.77	1.88	2.00	2.24	2.52	0.00	0.03	0.04	0.05
300	0.89	1.04	1.13	1.22	1.31	1.42	1.52	1.63	1.92	2.20	2.34	2.48	2.64	2.80	3.14	3.54	0.01	0.04	0.06	0.07
400	1.11	1.31	1.43	1.54	1.65	1.79	1.92	2.06	2.43	2.78	2.96	3.13	3.34	3.55	3.98	4.48	0.01	0.06	0.08	0.10
500	1.32	1.56	1.70	1.84	1.97	2.13	2.29	2.47	2.91	3.34	3.55	3.76	4.00	4.25	4.77	5.36	0.01	0.07	0.10	0.12
600	1.52	1.79	1.95	2.12	2.28	2.46	2.64	2.85	3.36	3.86	4.10	4.35	4.63	4.92	5.52	6.20	0.01	0.08	0.12	0.15
700	1.70	2.01	2.20	2.38	2.56	2.77	2.98	3.22	3.79	4.36	4.63	4.91	5.23	5.55	6.23	6.99	0.02	0.10	0.14	0.17
800	1.87	2.22	2.43	2.64	2.84	3.07	3.31	3.57	4.21	4.84	5.14	5.45	5.80	6.16	6.91	7.74	0.02	0.11	0.16	0.20
900	2.04	2.43	2.65	2.88	3.10	3.36	3.61	3.90	4.61	5.29	5.63	5.96	6.35	6.74	7.55	8.46	0.02	0.13	0.18	0.22
1000	2.20	2.62	2.87	3.11	3.35	3.64	3.91	4.23	4.99	5.73	6.09	6.45	6.87	7.29	8.16	9.13	0.02	0.14	0.20	0.24
1100	2.35	2.80	3.07	3.34	3.60	3.90	4.20	4.54	5.36	6.15	6.54	6.92	7.37	7.81	8.74	9.76	0.02	0.15	0.22	0.27
1200	2.49	2.98	3.27	3.55	3.83	4.16	4.47	4.83	5.71	6.56	6.97	7.37	7.85	8.32	9.29	10.36	0.03	0.17	0.24	0.29
1300	2.63	3.15	3.46	3.76	4.06	4.40	4.74	5.12	6.05	6.95	7.38	7.81	8.31	8.79	9.81	10.92	0.03	0.18	0.26	0.32
1400	2.76	3.31	3.64	3.96	4.27	4.64	5.00	5.40	6.38	7.32	7.77	8.22	8.74	9.25	10.30	11.43	0.03	0.20	0.28	0.34
1500	2.89	3.47	3.81	4.15	4.48	4.87	5.24	5.67	6.69	7.67	8.15	8.61	9.15	9.68	10.76	11.91	0.03	0.21	0.30	0.37
1600	3.01	3.62	3.98	4.34	4.69	5.09	5.48	5.92	6.99	8.01	8.50	8.98	9.54	10.08	11.18	12.35	0.03	0.22	0.32	0.39
1700	3.13	3.77	4.15	4.51	4.88	5.30	5.71	6.17	7.28	8.34	8.84	9.33	9.91	10.46	11.58	12.74	0.04	0.24	0.34	0.42
1800	3.24	3.91	4.30	4.69	5.07	5.50	5.93	6.41	7.56	8.64	9.16	9.67	10.25	10.81	11.94	13.09	0.04	0.25	0.36	0.44
1900	3.35	4.05	4.45	4.85	5.25	5.70	6.14	6.63	7.82	8.94	9.47	9.98	10.57	11.14	12.27	13.40	0.04	0.27	0.38	0.46
2000	3.45	4.17	4.60	5.01	5.42	5.88	6.34	6.85	8.07	9.21	9.75	10.27	10.87	11.44	12.56	13.66	0.04	0.28	0.40	0.49
2100	3.55	4.30	4.74	5.16	5.58	6.07	6.54	7.06	8.31	9.47	10.02	10.55	11.15	11.71	12.82	13.88	0.05	0.29	0.42	0.51
2200	3.65	4.42	4.87	5.31	5.74	6.24	6.72	7.26	8.54	9.72	10.27	10.80	11.40	11.96	13.04	14.04	0.05	0.31	0.44	0.54
2300	3.74	4.53	5.00	5.45	5.90	6.40	6.90	7.45	8.75	9.94	10.50	11.03	11.62	12.18	13.22	14.16	0.05	0.32	0.46	0.56
2400	3.83	4.64	5.12	5.58	6.04	6.56	7.07	7.63	8.95	10.15	10.71	11.24	11.82	12.37	13.37	14.22	0.05	0.34	0.48	0.59
2500	3.91	4.75	5.24	5.71	6.18	6.71	7.23	7.80	9.14	10.35	10.90	11.42	12.00	12.53	13.48	14.24	0.05	0.35	0.50	0.61
2600	3.99	4.85	5.35	5.83	6.31	6.85	7.38	7.96	9.31	10.52	11.07	11.58	12.15	12.65	13.54	14.19	0.06	0.36	0.52	0.64
2700	4.06	4.94	5.45	5.95	6.44	6.99	7.52	8.11	9.47	10.68	11.22	11.73	12.27	12.75	13.57	14.10	0.06	0.38	0.54	0.66
2800	4.13	5.03	5.55	6.06	6.55	7.11	7.65	8.25	9.62	10.82	11.35	11.84	12.37	12.82	13.55	-	0.06	0.39	0.56	0.68
2900	4.20	5.11	5.65	6.16	6.67	7.23	7.78	8.38	9.75	10.94	11.46	11.93	12.43	12.86	13.49	-	0.06	0.41	0.58	0.71
3000	4.26	5.19	5.74	6.26	6.77	7.34	7.89	8.50	9.87	11.04	11.55	12.00	12.47	12.86	13.39	-	0.06	0.42	0.60	0.73
3100	4.32	5.27	5.82	6.35	6.87	7.45	8.00	8.61	9.97	11.13	11.62	12.05	12.48	12.83	-	-	0.07	0.43	0.62	0.76
3200	4.37	5.34	5.90	6.44	6.96	7.54	8.10	8.71	10.06	11.19	11.66	12.06	12.46	12.76	-	-	0.07	0.45	0.64	0.78
3300	4.42	5.40	5.97	6.51	7.04	7.63	8.19	8.79	10.14	11.23	11.68	12.06	12.41	12.66	-	-	0.07	0.46	0.66	0.81
3400	4.47	5.46	6.04	6.59	7.12	7.71	8.27	8.87	10.20	11.26	11.68	12.02	12.33	12.52	-	-	0.07	0.48	0.68	0.83
3500	4.51	5.52	6.10	6.65	7.19	7.78	8.34	8.94	10.25	11.26	11.65	11.96	12.22	-	-	-	0.08	0.49	0.70	0.86
3600	4.55	5.57	6.15	6.71	7.25	7.84	8.40	9.00	10.28	11.24	11.60	11.87	12.07	-	-	-	0.08	0.50	0.72	0.88
3700	4.58	5.61	6.20	6.76	7.30	7.89	8.45	9.04	10.29	11.21	11.53	11.75	-	-	-	-	0.08	0.52	0.74	0.90
3800	4.61	5.65	6.25	6.81	7.35	7.94	8.49	9.08	10.29	11.15	11.43	11.60	-	-	-	-	0.08	0.53	0.75	0.93
3900	4.64	5.69	6.28	6.85	7.39	7.98	8.53	9.10	10.28	11.06	11.30	-	-	-	-	-	0.08	0.55	0.77	0.95
4000	4.66	5.72	6.32	6.88	7.42	8.01	8.55	9.11	10.24	10.96	11.15	-	-	-	-	-	0.09	0.56	0.79	0.98
4100	4.68	5.74	6.34	6.91	7.44	8.03	8.56	9.11	10.19	10.83	-	-	-	-	-	-	0.09	0.57	0.81	1.00
4200	4.69	5.76	6.36	6.93	7.46	8.04	8.56	9.10	10.13	10.68	-	-	-	-	-	-	0.09	0.59	0.83	1.03
4300	4.70	5.78	6.38	6.94	7.47	8.04	8.55	9.07	10.04	-	-	-	-	-	-	-	0.09	0.60	0.85	1.05
4400	4.71	5.79	6.39	6.95	7.47	8.03	8.53	9.03	9.94	-	-	-	-	-	-	-	0.10	0.62	0.87	1.07
4500	4.71	5.79	6.39	6.95	7.46	8.01	8.50	8.99	9.82	-	-	-	-	-	-	-	0.10	0.63	0.89	1.10
4600	4.71	5.79	6.39	6.94	7.45	7.99	8.46	8.92	9.68	-	-	-	-	-	-	-	0.10	0.64	0.91	1.12
4700	4.70	5.78	6.38	6.92	7.43	7.95	8.41	8.85	9.53	-	-	-	-	-	-	-	0.10	0.66	0.93	1.15
4800	4.69	5.77	6.36	6.90	7.39	7.91	8.35	8.76	-	-	-	-	-	-	-	-	0.10	0.67	0.95	1.17
4900	4.67	5.75	6.34	6.87	7.35	7.85	8.27	8.66	-	-	-	-	-	-	-	-	0.11	0.69	0.97	1.20
5000	4.65	5.73	6.31	6.83	7.30	7.78	8.19	8.54	-	-	-	-	-	-	-	-	0.11	0.70	0.99	1.22

 Belt speed is over 30 m/sec. to 35 m/sec. Please consult our sales company or Engineering Department.

 Belt speed is over 35 m/sec. to 40 m/sec. Please consult our sales company or Engineering Department.

2

Design

C/22-Section Power Rating

Table 2-26

[kw]

small pulley pitch speed nd(rpm)	Basic power rating for small pulley pitch diameter : Ps															Additional power rating for speed ratio (Pa)			
	Small pulley pitch diameter dp (mm)															Speed ratio			
	180	200	212	224	236	250	265	280	300	315	335	355	375	400	450	1.01 to 1.05	1.06 to 1.26	1.27 to 1.57	1.57<
700	4.51	5.66	6.34	7.01	7.68	8.45	9.27	10.08	11.14	11.92	12.96	13.97	14.97	16.19	18.55	0.07	0.44	0.62	0.77
950	5.59	7.07	7.94	8.80	9.65	10.63	11.66	12.67	13.98	14.95	16.21	17.44	18.63	20.06	22.75	0.09	0.60	0.85	1.04
1450	7.22	9.23	10.40	11.54	12.65	13.91	15.21	16.47	18.05	19.18	20.60	21.91	23.11	24.46	26.58	0.14	0.91	1.29	1.59
2850	7.56	9.83	10.98	11.95	12.75	13.44	13.88	-	-	-	-	-	-	-	-	0.28	1.79	2.54	3.12
50	0.53	0.64	0.70	0.76	0.83	0.90	0.98	1.06	1.16	1.24	1.34	1.44	1.54	1.67	1.92	0.00	0.03	0.04	0.05
100	0.96	1.16	1.28	1.40	1.51	1.65	1.80	1.95	2.14	2.28	2.48	2.67	2.86	3.09	3.56	0.01	0.06	0.09	0.11
150	1.34	1.63	1.80	1.98	2.15	2.35	2.56	2.77	3.05	3.26	3.54	3.81	4.09	4.43	5.10	0.01	0.09	0.13	0.16
200	1.70	2.07	2.30	2.52	2.75	3.00	3.28	3.55	3.92	4.19	4.55	4.90	5.26	5.70	6.57	0.02	0.13	0.18	0.22
250	2.03	2.49	2.77	3.04	3.32	3.63	3.97	4.30	4.75	5.08	5.51	5.95	6.38	6.92	7.97	0.02	0.16	0.22	0.27
300	2.35	2.90	3.22	3.54	3.86	4.24	4.63	5.03	5.55	5.93	6.45	6.96	7.46	8.09	9.33	0.03	0.19	0.27	0.33
350	2.66	3.28	3.66	4.03	4.39	4.82	5.27	5.73	6.32	6.76	7.35	7.93	8.51	9.23	10.64	0.03	0.22	0.31	0.38
400	2.95	3.66	4.08	4.49	4.91	5.39	5.90	6.40	7.07	7.57	8.23	8.88	9.53	10.33	11.90	0.04	0.25	0.36	0.44
450	3.23	4.02	4.48	4.94	5.40	5.93	6.50	7.06	7.80	8.35	9.08	9.80	10.51	11.39	13.12	0.04	0.28	0.40	0.49
500	3.51	4.37	4.88	5.38	5.89	6.47	7.09	7.70	8.51	9.11	9.90	10.69	11.46	12.42	14.30	0.05	0.31	0.44	0.55
550	3.77	4.70	5.26	5.81	6.35	6.99	7.66	8.32	9.20	9.85	10.70	11.55	12.39	13.42	15.43	0.05	0.34	0.49	0.60
600	4.03	5.03	5.63	6.22	6.81	7.49	8.21	8.92	9.86	10.56	11.48	12.38	13.28	14.38	16.51	0.06	0.38	0.53	0.66
650	4.27	5.35	5.99	6.62	7.25	7.98	8.75	9.51	10.51	11.25	12.23	13.19	14.14	15.30	17.56	0.06	0.41	0.58	0.71
700	4.51	5.66	6.34	7.01	7.68	8.45	9.27	10.08	11.14	11.92	12.96	13.97	14.97	16.19	18.55	0.07	0.44	0.62	0.77
750	4.74	5.96	6.68	7.39	8.10	8.92	9.78	10.63	11.75	12.57	13.66	14.72	15.77	17.04	19.49	0.07	0.47	0.67	0.82
800	4.97	6.25	7.01	7.76	8.51	9.36	10.27	11.16	12.34	13.20	14.34	15.45	16.53	17.86	20.39	0.08	0.50	0.71	0.88
850	5.18	6.53	7.33	8.12	8.90	9.80	10.75	11.68	12.91	13.81	14.99	16.14	17.26	18.63	21.23	0.08	0.53	0.76	0.93
900	5.39	6.80	7.64	8.47	9.28	10.22	11.21	12.18	13.46	14.39	15.61	16.80	17.96	19.37	22.02	0.09	0.56	0.80	0.98
950	5.59	7.07	7.94	8.80	9.65	10.63	11.66	12.67	13.98	14.95	16.21	17.44	18.63	20.06	22.75	0.09	0.60	0.85	1.04
1000	5.78	7.32	8.23	9.13	10.01	11.02	12.09	13.13	14.49	15.49	16.78	18.04	19.25	20.71	23.43	0.10	0.63	0.89	1.09
1050	5.97	7.57	8.51	9.44	10.35	11.40	12.50	13.58	14.98	16.00	17.33	18.61	19.85	21.32	24.04	0.10	0.66	0.93	1.15
1100	6.15	7.81	8.78	9.74	10.68	11.77	12.90	14.01	15.44	16.49	17.84	19.15	20.40	21.89	24.60	0.11	0.69	0.98	1.20
1150	6.33	8.04	9.04	10.03	11.01	12.12	13.28	14.42	15.89	16.96	18.33	19.65	20.91	22.40	25.09	0.11	0.72	1.02	1.26
1200	6.49	8.26	9.30	10.31	11.31	12.45	13.65	14.81	16.31	17.39	18.79	20.12	21.39	22.87	25.51	0.12	0.75	1.07	1.31
1250	6.65	8.47	9.54	10.58	11.61	12.78	14.00	15.18	16.71	17.81	19.21	20.55	21.82	23.29	25.87	0.12	0.78	1.11	1.37
1300	6.80	8.67	9.77	10.84	11.89	13.08	14.33	15.53	17.08	18.19	19.61	20.91	22.21	23.66	26.16	0.13	0.81	1.16	1.42
1350	6.95	8.87	9.99	11.09	12.16	13.38	14.64	15.86	17.43	18.55	19.97	21.31	22.56	23.98	26.37	0.13	0.85	1.20	1.48
1400	7.09	9.05	10.20	11.32	12.41	13.65	14.94	16.18	17.75	18.88	20.30	21.63	22.86	24.25	26.51	0.14	0.88	1.25	1.53
1450	7.22	9.23	10.40	11.54	12.65	13.91	15.21	16.47	18.05	19.18	20.60	21.91	23.11	24.46	26.58	0.14	0.91	1.29	1.59
1500	7.34	9.40	10.59	11.75	12.88	14.16	15.47	16.73	18.33	19.45	20.86	22.15	23.32	24.61	26.56	0.15	0.94	1.33	1.64
1550	7.45	9.55	10.77	11.95	13.09	14.39	15.71	16.98	18.57	19.69	21.08	22.35	23.48	24.70	26.46	0.15	0.97	1.38	1.70
1600	7.56	9.70	10.93	12.13	13.29	14.60	15.93	17.21	18.80	19.91	21.27	22.50	23.59	24.74	26.28	0.16	1.00	1.42	1.75
1650	7.66	9.84	11.09	12.30	13.48	14.79	16.13	17.41	18.99	20.09	21.42	22.61	23.65	24.71	26.02	0.16	1.03	1.47	1.81
1700	7.76	9.97	11.24	12.46	13.65	14.97	16.31	17.58	19.15	20.23	21.54	22.68	23.65	24.62	-	0.16	1.07	1.51	1.86
1750	7.84	10.08	11.37	12.61	13.80	15.13	16.47	17.74	19.29	20.35	21.61	22.70	23.60	24.47	-	0.17	1.10	1.56	1.91
1800	7.92	10.19	11.49	12.74	13.94	15.27	16.61	17.87	19.39	20.43	21.64	22.67	23.50	24.25	-	0.17	1.13	1.60	1.97
1850	7.99	10.29	11.60	12.86	14.06	15.39	16.73	17.97	19.47	20.47	21.64	22.60	23.34	23.96	-	0.18	1.16	1.65	2.02
1900	8.05	10.38	11.70	12.96	14.17	15.50	16.82	18.05	19.52	20.48	21.59	22.47	23.13	23.60	-	0.18	1.19	1.69	2.08
1950	8.11	10.45	11.78	13.05	14.26	15.58	16.90	18.10	19.53	20.46	21.50	22.30	22.85	-	-	0.19	1.22	1.73	2.13
2000	8.15	10.52	11.86	13.13	14.33	15.65	16.95	18.13	19.51	20.39	21.36	22.07	22.51	-	-	0.19	1.25	1.78	2.19
2050	8.19	10.57	11.92	13.19	14.39	15.69	16.97	18.13	19.46	20.29	21.18	21.79	-	-	-	0.20	1.28	1.82	2.24
2100	8.22	10.62	11.96	13.23	14.43	15.72	16.98	18.10	19.37	20.16	20.95	21.46	-	-	-	0.20	1.32	1.87	2.30
2150	8.24	10.65	12.00	13.26	14.45	15.73	16.96	18.04	19.26	19.98	20.68	21.07	-	-	-	0.21	1.35	1.91	2.35
2200	8.25	10.67	12.02	13.28	14.45	15.71	16.91	17.96	19.10	19.76	20.36	-	-	-	-	0.21	1.38	1.96	2.41
2250	8.25	10.68	12.02	13.28	14.44	15.67	16.84	17.85	18.91	19.50	19.99	-	-	-	-	0.22	1.41	2.00	2.46
2300	8.25	10.68	12.02	13.26	14.41	15.61	16.75	17.70	18.69	19.20	-	-	-	-	-	0.22	1.44	2.05	2.52
2350	8.23	10.66	12.00	13.23	14.36	15.53	16.62	17.53	18.43	18.86	-	-	-	-	-	0.23	1.47	2.09	2.57
2400	8.21	10.64	11.96	13.18	14.29	15.43	16.48	17.32	18.13	18.48	-	-	-	-	-	0.23	1.50	2.14	2.63
2450	8.17	10.60	11.91	13.11	14.20	15.31	16.30	17.09	17.79	-	-	-	-	-	-	0.24	1.54	2.18	2.68
2500	8.13	10.55	11.85	13.03	14.09	15.16	16.10	16.82	17.42	-	-	-	-	-	-	0.24	1.57	2.22	2.74
2550	8.08	10.49	11.77	12.93	13.96	14.99	15.87	16.52	-	-	-	-	-	-	-	0.25	1.60	2.27	2.79
2600	8.02	10.41	11.68	12.81	13.81	14.79	15.61	16.19	-	-	-	-	-	-	-	0.25	1.63	2.31	2.84
2650	7.95	10.32	11.57	12.68	13.64	14.57	15.33	15.82	-	-	-	-	-	-	-	0.26	1.66	2.36	2.90
2700	7.86	10.22	11.44	12.52	13.45	14.33	15.01	15.42	-	-	-	-	-	-	-	0.26	1.69	2.40	2.95
2750	7.77	10.10	11.30	12.35	13.24	14.06	14.67	-	-	-	-	-	-	-	-	0.27	1.72	2.45	3.01
2800	7.67	9.97	11.15	12.16	13.00	13.76	14.29	-	-	-	-	-	-	-	-	0.27	1.75	2.49	3.06
2850	7.56	9.83	10.98	11.95	12.75	13.44	13.88	-	-	-	-	-	-	-	-	0.28	1.79	2.54	3.12
2900	7.44	9.67	10.79	11.72	12.47	13.09	-	-	-	-	-	-	-	-	-	0.28	1.82	2.58	3.17
2950	7.30	9.50	10.58	11.47	12.17	12.72	-	-	-	-	-	-	-	-	-	0.29	1.85	2.62	3.23
3000	7.16	9.31	10.36	11.21	11.85	12.32	-	-	-	-	-	-	-	-	-	0.29	1.88	2.67	3.28
3050	7.00	9.11	10.12	10.92	11.50	11.89	-	-	-	-</									

CX-Section Power Rating

Table 2-27

[kw]

small pulley pitch speed nd(rpm)	Basic power rating for small pulley pitch diameter : Ps															Additional power rating for speed ratio (Pa)			
	Small pulley pitch diameter dp (mm)															Speed ratio			
	140	150	160	180	200	224	250	280	315	335	355	400	450	500	630	1.01 to 1.05	1.06 to 1.26	1.27 to 1.57	<1.57
700	4.82	5.30	5.77	6.70	7.60	8.67	9.79	11.05	12.47	13.26	14.04	15.73	17.51	19.20	23.11	0.03	0.18	0.26	0.32
950	6.08	6.69	7.29	8.47	9.62	10.96	12.36	13.91	15.65	16.60	17.52	19.49	21.50	23.32	27.04	0.04	0.25	0.36	0.44
1450	8.25	9.09	9.91	11.50	13.03	14.78	16.56	18.47	20.50	21.56	22.53	24.43	26.03	27.05	-	0.06	0.38	0.54	0.67
2850	12.18	13.36	14.48	16.48	18.17	19.77	20.92	-	-	-	-	-	-	-	-	0.12	0.75	1.07	1.31
50	0.54	0.59	0.64	0.74	0.83	0.94	1.06	1.20	1.35	1.44	1.53	1.73	1.94	2.15	2.69	0.00	0.01	0.02	0.02
100	0.98	1.07	1.16	1.34	1.51	1.72	1.94	2.19	2.48	2.64	2.80	3.16	3.55	3.93	4.91	0.00	0.03	0.04	0.05
150	1.38	1.51	1.64	1.89	2.14	2.43	2.74	3.10	3.51	3.74	3.96	4.47	5.02	5.56	6.94	0.01	0.04	0.06	0.07
200	1.76	1.92	2.09	2.41	2.73	3.10	3.50	3.96	4.48	4.77	5.06	5.71	6.41	7.10	8.84	0.01	0.05	0.07	0.09
250	2.12	2.32	2.51	2.90	3.29	3.74	4.23	4.78	5.40	5.76	6.11	6.89	7.73	8.56	10.64	0.01	0.07	0.09	0.11
300	2.46	2.69	2.92	3.38	3.83	4.36	4.92	5.56	6.29	6.71	7.11	8.02	9.00	9.95	12.35	0.01	0.08	0.11	0.14
350	2.78	3.05	3.31	3.83	4.35	4.95	5.59	6.32	7.15	7.62	8.08	9.10	10.21	11.29	13.97	0.01	0.09	0.13	0.16
400	3.10	3.40	3.69	4.28	4.85	5.53	6.24	7.06	7.98	8.50	9.02	10.15	11.38	12.57	15.51	0.02	0.11	0.15	0.18
450	3.41	3.74	4.06	4.71	5.34	6.08	6.87	7.77	8.79	9.36	9.92	11.16	12.50	13.80	16.98	0.02	0.12	0.17	0.21
500	3.70	4.07	4.42	5.13	5.82	6.63	7.49	8.46	9.57	10.19	10.80	12.14	13.58	14.98	18.37	0.02	0.13	0.19	0.23
550	3.99	4.39	4.77	5.53	6.28	7.16	8.09	9.13	10.32	10.99	11.65	13.08	14.63	16.11	19.68	0.02	0.14	0.21	0.25
600	4.28	4.70	5.11	5.93	6.73	7.67	8.67	9.79	11.06	11.77	12.47	14.00	15.63	17.19	20.90	0.02	0.16	0.22	0.28
650	4.55	5.00	5.44	6.32	7.17	8.17	9.23	10.43	11.78	12.53	13.27	14.88	16.59	18.22	22.05	0.03	0.17	0.24	0.30
700	4.82	5.30	5.77	6.70	7.60	8.67	9.79	11.05	12.47	13.26	14.04	15.73	17.51	19.20	23.11	0.03	0.18	0.26	0.32
750	5.08	5.59	6.09	7.07	8.02	9.15	10.33	11.65	13.15	13.97	14.78	16.54	18.39	20.13	24.08	0.03	0.20	0.28	0.34
800	5.34	5.87	6.40	7.43	8.44	9.61	10.86	12.24	13.80	14.66	15.51	17.33	19.23	21.00	24.96	0.03	0.21	0.30	0.37
850	5.59	6.15	6.70	7.79	8.84	10.07	11.37	12.81	14.44	15.33	16.20	18.08	20.03	21.83	25.75	0.03	0.22	0.32	0.39
900	5.84	6.43	7.00	8.13	9.23	10.52	11.87	13.37	15.05	15.98	16.88	18.80	20.79	22.60	26.44	0.04	0.24	0.34	0.41
950	6.08	6.69	7.29	8.47	9.62	10.96	12.36	13.91	15.65	16.60	17.52	19.49	21.50	23.32	27.04	0.04	0.25	0.36	0.44
1000	6.32	6.95	7.58	8.81	10.00	11.38	12.83	14.44	16.23	17.20	18.14	20.15	22.17	23.97	27.52	0.04	0.26	0.37	0.46
1050	6.55	7.21	7.86	9.13	10.37	11.80	13.30	14.95	16.78	17.78	18.74	20.77	22.80	24.57	27.91	0.04	0.28	0.39	0.48
1100	6.78	7.46	8.14	9.45	10.73	12.21	13.75	15.45	17.32	18.34	19.31	21.36	23.37	25.11	28.17	0.04	0.29	0.41	0.51
1150	7.00	7.71	8.41	9.77	11.08	12.61	14.19	15.93	17.84	18.87	19.85	21.91	23.91	25.59	28.33	0.05	0.30	0.43	0.53
1200	7.22	7.95	8.67	10.07	11.43	12.99	14.62	16.39	18.33	19.38	20.37	22.42	24.39	26.00	28.36	0.05	0.32	0.45	0.55
1250	7.43	8.19	8.93	10.37	11.76	13.37	15.03	16.84	18.81	19.86	20.86	22.90	24.82	26.35	-	0.05	0.33	0.47	0.57
1300	7.64	8.42	9.18	10.66	12.09	13.74	15.43	17.27	19.26	20.32	21.32	23.34	25.20	26.63	-	0.05	0.34	0.49	0.60
1350	7.85	8.65	9.43	10.95	12.41	14.10	15.82	17.69	19.70	20.76	21.75	23.75	25.53	26.84	-	0.05	0.36	0.50	0.62
1400	8.05	8.87	9.67	11.23	12.73	14.44	16.20	18.09	20.11	21.17	22.16	24.11	25.81	26.98	-	0.06	0.37	0.52	0.64
1450	8.25	9.09	9.91	11.50	13.03	14.78	16.56	18.47	20.50	21.56	22.53	24.43	26.03	27.05	-	0.06	0.38	0.54	0.67
1500	8.44	9.30	10.14	11.77	13.33	15.11	16.91	18.84	20.87	21.92	22.88	24.72	26.20	27.04	-	0.06	0.39	0.56	0.69
1550	8.63	9.51	10.37	12.03	13.62	15.42	17.25	19.19	21.21	22.25	23.19	24.96	26.31	-	-	0.06	0.41	0.58	0.71
1600	8.81	9.71	10.59	12.29	13.90	15.73	17.58	19.53	21.54	22.56	23.47	25.16	26.36	-	-	0.07	0.42	0.60	0.74
1650	9.00	9.91	10.81	12.54	14.18	16.03	17.89	19.84	21.84	22.83	23.72	25.31	26.35	-	-	0.07	0.43	0.62	0.76
1700	9.17	10.11	11.02	12.78	14.44	16.32	18.19	20.14	22.11	23.09	23.94	25.42	-	-	-	0.07	0.45	0.64	0.78
1750	9.35	10.30	11.23	13.01	14.70	16.59	18.47	20.42	22.36	23.31	24.13	25.48	-	-	-	0.07	0.46	0.65	0.80
1800	9.52	10.49	11.43	13.24	14.95	16.86	18.75	20.68	22.59	23.50	24.28	25.50	-	-	-	0.07	0.47	0.67	0.83
1850	9.68	10.67	11.63	13.46	15.19	17.11	19.00	20.92	22.79	23.67	24.40	25.47	-	-	-	0.08	0.49	0.69	0.85
1900	9.85	10.85	11.82	13.68	15.42	17.36	19.25	21.15	22.97	23.80	24.48	25.39	-	-	-	0.08	0.50	0.71	0.87
1950	10.00	11.02	12.01	13.89	15.65	17.59	19.48	21.35	23.12	23.91	24.52	-	-	-	-	0.08	0.51	0.73	0.90
2000	10.16	11.19	12.19	14.09	15.86	17.81	19.69	21.54	23.24	23.98	24.53	-	-	-	-	0.08	0.53	0.75	0.92
2050	10.31	11.35	12.37	14.29	16.07	18.02	19.89	21.71	23.34	24.02	24.51	-	-	-	-	0.08	0.54	0.77	0.94
2100	10.45	11.51	12.54	14.48	16.27	18.22	20.07	21.85	23.41	24.03	24.44	-	-	-	-	0.09	0.55	0.78	0.97
2150	10.60	11.67	12.70	14.66	16.46	18.41	20.24	21.98	23.45	24.00	24.34	-	-	-	-	0.09	0.57	0.80	0.99
2200	10.74	11.82	12.87	14.84	16.64	18.59	20.40	22.09	23.46	23.95	-	-	-	-	-	0.09	0.58	0.82	1.01
2250	10.87	11.97	13.02	15.01	16.82	18.75	20.54	22.17	23.45	23.85	-	-	-	-	-	0.09	0.59	0.84	1.03
2300	11.00	12.11	13.17	15.17	16.98	18.91	20.66	22.23	23.40	-	-	-	-	-	-	0.09	0.61	0.86	1.06
2350	11.13	12.25	13.32	15.32	17.14	19.05	20.77	22.28	23.33	-	-	-	-	-	-	0.10	0.62	0.88	1.08
2400	11.25	12.38	13.46	15.47	17.28	19.18	20.86	22.30	23.22	-	-	-	-	-	-	0.10	0.63	0.90	1.10
2450	11.37	12.51	13.59	15.61	17.42	19.29	20.94	22.29	-	-	-	-	-	-	-	0.10	0.65	0.92	1.13
2500	11.49	12.63	13.72	15.75	17.55	19.40	21.04	22.27	-	-	-	-	-	-	-	0.10	0.66	0.93	1.15
2550	11.60	12.75	13.85	15.87	17.67	19.49	21.04	22.22	-	-	-	-	-	-	-	0.10	0.67	0.95	1.17
2600	11.71	12.86	13.97	15.99	17.78	19.57	21.06	22.15	-	-	-	-	-	-	-	0.11	0.68	0.97	1.19
2650	11.81	12.97	14.08	16.11	17.87	19.64	21.07	22.06	-	-	-	-	-	-	-	0.11	0.70	0.99	1.22
2700	11.91	13.08	14.19	16.21	17.96	19.69	21.06	21.94	-	-	-	-	-	-	-	0.11	0.71	1.01	1.24
2750	12.00	13.18	14.29	16.31	18.04	19.73	21.03	-	-	-	-	-	-	-	-	0.11	0.72	1.03	1.26
2800	12.09	13.27	14.39	16.40	18.11	19.76	20.99	-	-	-	-	-	-	-	-	0.11	0.74	1.05	1.29
2850	12.18	13.36	14.48	16.48	18.17	19.77	20.92	-	-	-	-	-	-	-	-	0.12	0.75	1.07	1.31
2900	12.26	13.45	14.56	16.55	18.22	19.77	20.84	-	-	-	-	-	-	-	-	0.12	0.76	1.08	1.33
2950	12.34	13.53	14.64	16.62	18.26	19.75	20.74	-	-	-	-	-	-	-	-	0.12	0.78	1.10	1.36
3000	12.42	13.61	14.71	16.68	18.29	19.73	20.62	-	-	-	-	-	-	-	-	0.12	0.79	1.12	1.38
3050	12.49	13.68	14.78	16.73	18.31	19.68	20.48	-	-	-	-	-	-	-	-	0.12	0.80	1.14	1.40
3100	12.55	13.74	14.84	16.77	18.32	19.63	-</												

D/32-Section Power Rating

Table 2-28

[kw]

small pulley pitch speed nd(rpm)	Basic power rating for small pulley pitch diameter : Ps														Additional power rating for speed ratio (Pa)			
	Small pulley pitch diameter dp (mm)														Speed ratio			
	315	355	375	400	425	450	500	560	630	670	710	750	800	900	1.01 to 1.05	1.06 to 1.26	1.27 to 1.57	< 1.57
450	11.07	13.80	15.15	16.82	18.46	20.08	23.27	26.98	31.16	33.47	35.72	37.91	40.56	45.56	0.13	0.81	1.15	1.42
700	15.30	19.17	21.06	23.37	25.62	27.82	32.06	36.82	41.92	44.59	47.07	49.37	51.96	56.12	0.20	1.26	1.79	2.21
950	18.50	23.20	25.45	28.16	30.75	33.22	37.79	42.57	47.08	49.10	50.69	51.82	52.57	-	0.27	1.71	2.43	2.99
1450	21.42	26.53	28.77	31.26	33.39	35.14	37.41	-	-	-	-	-	-	-	0.40	2.62	3.72	4.57
20	0.80	0.96	1.04	1.14	1.24	1.34	1.54	1.78	2.05	2.20	2.36	2.51	2.70	3.08	0.01	0.04	0.05	0.06
40	1.46	1.77	1.92	2.12	2.31	2.49	2.87	3.32	3.83	4.13	4.42	4.71	5.07	5.79	0.01	0.07	0.10	0.13
60	2.08	2.53	2.75	3.03	3.30	3.58	4.12	4.77	5.52	5.94	6.36	6.78	7.31	8.34	0.02	0.11	0.15	0.19
80	2.66	3.24	3.53	3.89	4.25	4.61	5.32	6.16	7.13	7.69	8.23	8.78	9.46	10.80	0.02	0.14	0.20	0.25
100	3.22	3.93	4.29	4.73	5.17	5.61	6.48	7.51	8.70	9.37	10.04	10.71	11.54	13.18	0.03	0.18	0.26	0.32
120	3.76	4.60	5.02	5.54	6.06	6.58	7.60	8.82	10.22	11.02	11.80	12.59	13.56	15.49	0.03	0.22	0.31	0.38
140	4.28	5.25	5.73	6.33	6.93	7.53	8.70	10.10	11.71	12.62	13.52	14.42	15.53	17.74	0.04	0.25	0.36	0.44
160	4.79	5.88	6.43	7.11	7.78	8.45	9.78	11.35	13.16	14.18	15.20	16.21	17.46	19.93	0.04	0.29	0.41	0.50
180	5.28	6.50	7.11	7.86	8.61	9.35	10.83	12.57	14.58	15.72	16.84	17.96	19.34	22.07	0.05	0.32	0.46	0.57
200	5.76	7.11	7.77	8.60	9.42	10.24	11.86	13.77	15.97	17.22	18.45	19.67	21.18	24.16	0.06	0.36	0.51	0.63
220	6.24	7.70	8.43	9.33	10.22	11.11	12.87	14.95	17.34	18.69	20.02	21.34	22.98	26.19	0.06	0.40	0.56	0.69
240	6.70	8.28	9.06	10.04	11.00	11.96	13.86	16.10	18.68	20.13	21.56	22.98	24.74	28.17	0.07	0.43	0.61	0.76
260	7.15	8.85	9.69	10.74	11.77	12.80	14.84	17.24	19.99	21.54	23.07	24.58	26.45	30.10	0.07	0.47	0.67	0.82
280	7.60	9.41	10.31	11.42	12.53	13.63	15.79	18.35	21.28	22.92	24.54	26.15	28.12	31.98	0.08	0.51	0.72	0.88
300	8.03	9.96	10.92	12.10	13.27	14.44	16.73	19.44	22.54	24.27	25.99	27.68	29.75	33.80	0.08	0.54	0.77	0.95
320	8.46	10.50	11.51	12.76	14.00	15.23	17.66	20.51	23.77	25.60	27.40	29.17	31.34	35.56	0.09	0.58	0.82	1.01
340	8.88	11.03	12.10	13.42	14.72	16.01	18.57	21.57	24.98	26.89	28.77	30.62	32.89	37.27	0.09	0.61	0.87	1.07
360	9.30	11.56	12.67	14.06	15.43	16.78	19.46	22.60	26.16	28.16	30.11	32.04	34.39	38.92	0.10	0.65	0.92	1.13
380	9.70	12.07	13.24	14.69	16.12	17.54	20.33	23.61	27.32	29.39	31.42	33.41	35.84	40.51	0.11	0.69	0.97	1.20
400	10.10	12.58	13.80	15.31	16.80	18.28	21.19	24.60	28.45	30.60	32.70	34.75	37.25	42.03	0.11	0.72	1.02	1.26
420	10.49	13.07	14.35	15.92	17.48	19.01	22.04	25.57	29.56	31.77	33.93	36.05	38.61	43.50	0.12	0.76	1.08	1.32
440	10.88	13.56	14.88	16.52	18.13	19.73	22.86	26.52	30.63	32.91	35.14	37.30	39.93	44.89	0.12	0.79	1.13	1.39
460	11.26	14.04	15.41	17.11	18.78	20.43	23.67	27.45	31.68	34.02	36.30	38.51	41.19	46.22	0.13	0.83	1.18	1.45
480	11.63	14.51	15.93	17.69	19.42	21.13	24.47	28.35	32.70	35.10	37.43	39.68	42.40	47.48	0.13	0.87	1.23	1.51
500	12.00	14.98	16.45	18.26	20.04	21.80	25.25	29.24	33.70	36.14	38.52	40.81	43.56	48.67	0.14	0.90	1.28	1.58
520	12.36	15.43	16.95	18.82	20.65	22.47	26.01	30.10	34.66	37.15	39.57	41.89	44.67	49.78	0.15	0.94	1.33	1.64
540	12.71	15.88	17.44	19.36	21.26	23.12	26.75	30.94	35.59	38.13	40.57	42.92	45.72	50.82	0.15	0.97	1.38	1.70
560	13.05	16.32	17.93	19.90	21.84	23.75	27.48	31.76	36.50	39.07	41.54	43.91	46.71	51.78	0.16	1.01	1.43	1.76
580	13.39	16.75	18.40	20.43	22.42	24.38	28.19	32.56	37.37	39.97	42.47	44.84	47.65	52.66	0.16	1.05	1.49	1.83
600	13.73	17.18	18.87	20.94	22.99	24.99	28.88	33.33	38.21	40.84	43.35	45.73	48.52	53.45	0.17	1.08	1.54	1.89
620	14.06	17.59	19.32	21.45	23.54	25.58	29.55	34.08	39.02	41.67	44.19	46.57	49.34	54.17	0.17	1.12	1.59	1.95
640	14.38	18.00	19.77	21.95	24.08	26.17	30.20	34.80	39.79	42.46	44.98	47.35	50.09	54.79	0.18	1.16	1.64	2.02
660	14.69	18.40	20.21	22.43	24.61	26.73	30.84	35.50	40.54	43.21	45.72	48.08	50.78	55.33	0.18	1.19	1.69	2.08
680	15.00	18.79	20.64	22.90	25.12	27.29	31.46	36.17	41.24	43.92	46.42	48.75	51.40	55.77	0.19	1.23	1.74	2.14
700	15.30	19.17	21.06	23.37	25.62	27.82	32.06	36.82	41.92	44.59	47.07	49.37	51.96	56.12	0.20	1.26	1.79	2.21
720	15.59	19.54	21.46	23.82	26.11	28.35	32.64	37.44	42.55	45.21	47.68	49.93	52.44	56.38	0.20	1.30	1.84	2.27
740	15.88	19.91	21.86	24.26	26.59	28.86	33.20	38.04	43.15	45.80	48.23	50.43	52.86	56.54	0.21	1.34	1.90	2.33
760	16.16	20.26	22.25	24.68	27.05	29.35	33.74	38.61	43.72	46.34	48.73	50.87	53.20	56.59	0.21	1.37	1.95	2.39
780	16.44	20.61	22.63	25.10	27.50	29.83	34.25	39.15	44.24	46.83	49.17	51.25	53.47	56.55	0.22	1.41	2.00	2.46
800	16.71	20.95	23.00	25.51	27.94	30.29	34.75	39.66	44.73	47.28	49.56	51.57	53.67	56.40	0.22	1.44	2.05	2.52
820	16.97	21.28	23.36	25.90	28.36	30.73	35.23	40.15	45.18	47.68	49.90	51.82	53.79	56.14	0.23	1.48	2.10	2.58
840	17.22	21.60	23.71	26.28	28.77	31.16	35.69	40.60	45.59	48.04	50.19	52.01	53.83	55.77	0.23	1.52	2.15	2.65
860	17.47	21.91	24.05	26.65	29.16	31.58	36.12	41.03	45.95	48.34	50.41	52.14	53.79	-	0.24	1.55	2.20	2.71
880	17.71	22.22	24.38	27.01	29.54	31.97	36.53	41.43	46.28	48.60	50.58	52.19	53.67	-	0.25	1.59	2.25	2.77
900	17.95	22.51	24.70	27.35	29.90	32.35	36.92	41.79	46.56	48.81	50.69	52.17	53.46	-	0.25	1.62	2.31	2.84
920	18.18	22.79	25.01	27.68	30.25	32.71	37.29	42.13	46.80	48.96	50.73	52.09	53.17	-	0.26	1.66	2.36	2.90
940	18.40	23.07	25.30	28.00	30.59	33.06	37.63	42.43	47.00	49.07	50.72	51.93	52.79	-	0.26	1.70	2.41	2.96
960	18.61	23.33	25.59	28.31	30.91	33.38	37.95	42.70	47.15	49.12	50.64	51.70	-	-	0.27	1.73	2.46	3.02
980	18.82	23.59	25.86	28.60	31.21	33.69	38.25	42.94	47.26	49.11	50.50	51.39	-	-	0.27	1.77	2.51	3.09
1000	19.01	23.83	26.13	28.88	31.50	33.98	38.52	43.15	47.32	49.05	50.30	51.01	-	-	0.28	1.81	2.56	3.15
1020	19.21	24.07	26.38	29.15	31.77	34.26	38.77	43.32	47.33	48.94	50.02	-	-	-	0.28	1.84	2.61	3.21
1040	19.39	24.30	26.62	29.40	32.03	34.51	38.99	43.46	47.29	48.77	49.68	-	-	-	0.29	1.88	2.66	3.28
1060	19.57	24.51	26.85	29.64	32.27	34.75	39.19	43.56	47.21	48.54	49.28	-	-	-	0.30	1.91	2.72	3.34
1080	19.74	24.72	27.07	29.86	32.50	34.96	39.36	43.63	47.08	48.25	-	-	-	-	0.30	1.95	2.77	3.40
1100	19.90	24.91	27.27	30.07	32.70	35.16	39.50	43.66	46.89	47.90	-	-	-	-	0.31	1.99	2.82	3.47
1120	20.05	25.10	27.46	30.27	32.89	35.33	39.62	43.65	46.66	47.49	-	-	-	-	0.31	2.02	2.87	3.53
1140	20.20	25.27	27.64	30.45	33.07	35.49	39.71	43.61	46.37	47.02	-	-	-	-	0.32	2.06	2.92	3.59
1160	20.34	25.44	27.81	30.62	33.22	35.63	39.78	43.53	46.04	-	-	-	-	-	0.32	2.09	2.97	3.65
1180	20.47	25.59	27.97	30.77	33.36	35.74	39.82	43.41	45.64	-	-	-	-	-	0.33	2.13	3.02	3.72
1200	20.59	25.73	28.11	30.90	33.48	35.84	39.83	43.26	45.20	-	-	-	-	-	0.34	2.17	3.07	3.78
1220	20.71	25.86	28.24	31.03	33.58	35.91	39.81	43.06	-	-	-	-	-	-	0.34	2.20	3.13	3.84
1240	20.81	25.98	28.36	3														

SPZ-Section Power Rating

Table 2-30

[kw]

small pulley speed nd (rpm)	Basic power rating for small pulley datum diameter : Ps															Additional power rating for speed ratio (Pa)			
	Small pulley datum diameter dd (mm)															Speed ratio			
	63	71	80	85	90	95	100	112	125	132	140	150	160	180	200	1.01 to 1.05	1.06 to 1.26	1.27 to 1.57	1.57<
700	0.49	0.68	0.88	0.99	1.10	1.22	1.33	1.59	1.88	2.03	2.20	2.41	2.63	3.05	3.47	0.01	0.06	0.09	0.11
950	0.63	0.87	1.14	1.29	1.44	1.58	1.73	2.08	2.46	2.66	2.88	3.17	3.45	4.00	4.54	0.01	0.09	0.12	0.15
1450	0.87	1.22	1.62	1.84	2.06	2.27	2.49	3.00	3.54	3.83	4.16	4.57	4.97	5.75	6.52	0.02	0.13	0.19	0.23
2850	1.38	2.03	2.75	3.14	3.52	3.91	4.28	5.16	6.08	6.56	7.10	7.74	8.36	9.53	10.58	0.04	0.26	0.37	0.46
100	0.10	0.13	0.16	0.18	0.20	0.22	0.23	0.28	0.32	0.35	0.38	0.41	0.45	0.52	0.59	0.00	0.01	0.01	0.02
200	0.18	0.23	0.30	0.33	0.37	0.40	0.44	0.52	0.61	0.66	0.71	0.78	0.85	0.98	1.11	0.00	0.02	0.03	0.03
300	0.25	0.33	0.42	0.47	0.53	0.58	0.63	0.75	0.88	0.95	1.03	1.13	1.22	1.42	1.61	0.00	0.03	0.04	0.05
400	0.31	0.42	0.54	0.61	0.68	0.74	0.81	0.97	1.14	1.23	1.33	1.46	1.59	1.84	2.09	0.01	0.04	0.05	0.06
500	0.38	0.51	0.66	0.74	0.82	0.91	0.99	1.18	1.39	1.50	1.63	1.79	1.94	2.25	2.56	0.01	0.05	0.07	0.08
600	0.44	0.59	0.77	0.87	0.97	1.06	1.16	1.39	1.64	1.77	1.92	2.10	2.29	2.66	3.02	0.01	0.06	0.08	0.10
700	0.49	0.68	0.88	0.99	1.10	1.22	1.33	1.59	1.88	2.03	2.20	2.41	2.63	3.05	3.47	0.01	0.06	0.09	0.11
800	0.55	0.76	0.99	1.11	1.24	1.37	1.49	1.79	2.11	2.28	2.48	2.72	2.96	3.44	3.91	0.01	0.07	0.11	0.13
900	0.60	0.83	1.09	1.23	1.37	1.51	1.65	1.98	2.34	2.53	2.75	3.02	3.29	3.81	4.33	0.01	0.08	0.12	0.15
1000	0.65	0.91	1.19	1.35	1.50	1.66	1.81	2.18	2.57	2.78	3.02	3.31	3.60	4.18	4.75	0.01	0.09	0.13	0.16
1100	0.70	0.98	1.29	1.46	1.63	1.80	1.96	2.36	2.79	3.02	3.28	3.60	3.92	4.55	5.16	0.02	0.10	0.14	0.18
1200	0.75	1.05	1.39	1.57	1.75	1.94	2.12	2.55	3.01	3.26	3.54	3.88	4.22	4.90	5.56	0.02	0.11	0.16	0.19
1300	0.80	1.12	1.48	1.68	1.88	2.07	2.27	2.73	3.23	3.49	3.79	4.16	4.53	5.25	5.95	0.02	0.12	0.17	0.21
1400	0.84	1.19	1.57	1.79	2.00	2.21	2.41	2.91	3.44	3.72	4.04	4.43	4.82	5.59	6.33	0.02	0.13	0.18	0.23
1500	0.89	1.26	1.67	1.89	2.11	2.34	2.56	3.08	3.64	3.94	4.28	4.70	5.11	5.92	6.70	0.02	0.14	0.20	0.24
1600	0.93	1.32	1.76	1.99	2.23	2.47	2.70	3.26	3.85	4.16	4.52	4.96	5.39	6.24	7.06	0.02	0.15	0.21	0.26
1700	0.97	1.39	1.84	2.10	2.35	2.59	2.84	3.43	4.05	4.38	4.75	5.22	5.67	6.56	7.41	0.02	0.16	0.22	0.27
1800	1.01	1.45	1.93	2.20	2.46	2.72	2.98	3.59	4.25	4.59	4.98	5.47	5.94	6.86	7.75	0.03	0.17	0.24	0.29
1900	1.05	1.51	2.02	2.29	2.57	2.84	3.11	3.76	4.44	4.80	5.21	5.71	6.20	7.16	8.08	0.03	0.18	0.25	0.31
2000	1.09	1.57	2.10	2.39	2.68	2.96	3.25	3.92	4.63	5.01	5.43	5.95	6.46	7.45	8.40	0.03	0.19	0.26	0.32
2100	1.13	1.63	2.18	2.48	2.78	3.08	3.38	4.08	4.81	5.21	5.65	6.19	6.71	7.73	8.70	0.03	0.19	0.28	0.34
2200	1.17	1.69	2.26	2.58	2.89	3.20	3.51	4.23	5.00	5.40	5.86	6.41	6.96	8.01	9.00	0.03	0.20	0.29	0.36
2300	1.20	1.74	2.34	2.67	2.99	3.31	3.63	4.38	5.17	5.59	6.06	6.64	7.19	8.27	9.28	0.03	0.21	0.30	0.37
2400	1.24	1.80	2.42	2.76	3.09	3.43	3.76	4.53	5.35	5.78	6.26	6.85	7.42	8.52	9.54	0.03	0.22	0.32	0.39
2500	1.27	1.85	2.49	2.85	3.19	3.54	3.88	4.68	5.52	5.96	6.46	7.06	7.65	8.76	9.80	0.04	0.23	0.33	0.40
2600	1.31	1.91	2.57	2.93	3.29	3.64	4.00	4.82	5.69	6.14	6.65	7.26	7.86	8.99	10.04	0.04	0.24	0.34	0.42
2700	1.34	1.96	2.64	3.02	3.39	3.75	4.11	4.96	5.85	6.31	6.83	7.46	8.07	9.22	10.27	0.04	0.25	0.35	0.44
2800	1.37	2.01	2.71	3.10	3.48	3.85	4.23	5.10	6.01	6.48	7.01	7.65	8.27	9.43	10.48	0.04	0.26	0.37	0.45
2900	1.40	2.06	2.78	3.18	3.57	3.96	4.34	5.23	6.16	6.64	7.18	7.83	8.46	9.63	10.67	0.04	0.27	0.38	0.47
3000	1.43	2.11	2.85	3.26	3.66	4.06	4.45	5.36	6.31	6.80	7.35	8.01	8.64	9.81	10.85	0.04	0.28	0.39	0.48
3100	1.46	2.15	2.92	3.34	3.75	4.15	4.55	5.48	6.45	6.95	7.51	8.18	8.82	9.99	11.02	0.04	0.29	0.41	0.50
3200	1.49	2.20	2.98	3.41	3.83	4.25	4.66	5.61	6.59	7.10	7.67	8.34	8.98	10.15	11.17	0.05	0.30	0.42	0.52
3300	1.51	2.24	3.05	3.49	3.92	4.34	4.76	5.73	6.73	7.24	7.81	8.49	9.14	10.30	11.30	0.05	0.31	0.43	0.53
3400	1.54	2.29	3.11	3.56	4.00	4.43	4.86	5.84	6.86	7.38	7.96	8.64	9.28	10.44	11.41	0.05	0.31	0.45	0.55
3500	1.56	2.33	3.17	3.63	4.08	4.52	4.95	5.96	6.99	7.51	8.09	8.78	9.42	10.57	11.51	0.05	0.32	0.46	0.57
3600	1.59	2.37	3.23	3.70	4.15	4.60	5.04	6.06	7.11	7.64	8.22	8.91	9.55	10.68	11.59	0.05	0.33	0.47	0.58
3700	1.61	2.41	3.29	3.76	4.23	4.69	5.13	6.17	7.22	7.76	8.34	9.03	9.67	10.78	11.65	0.05	0.34	0.49	0.60
3800	1.63	2.45	3.34	3.83	4.30	4.77	5.22	6.27	7.33	7.87	8.46	9.15	9.78	10.86	11.69	0.05	0.35	0.50	0.61
3900	1.65	2.49	3.40	3.89	4.37	4.85	5.31	6.37	7.44	7.98	8.57	9.25	9.88	10.93	-	0.06	0.36	0.51	0.63
4000	1.67	2.52	3.45	3.95	4.44	4.92	5.39	6.46	7.54	8.08	8.67	9.35	9.96	10.99	-	0.06	0.37	0.53	0.65
4100	1.69	2.56	3.50	4.01	4.51	4.99	5.47	6.55	7.64	8.18	8.76	9.44	10.04	11.03	-	0.06	0.38	0.54	0.66
4200	1.71	2.59	3.55	4.07	4.57	5.06	5.54	6.64	7.73	8.27	8.85	9.51	10.11	11.05	-	0.06	0.39	0.55	0.68
4300	1.73	2.63	3.60	4.12	4.63	5.13	5.62	6.72	7.81	8.35	8.93	9.58	10.16	-	-	0.06	0.40	0.56	0.69
4400	1.74	2.66	3.65	4.18	4.69	5.20	5.69	6.79	7.89	8.43	9.00	9.64	10.20	-	-	0.06	0.41	0.58	0.71
4500	1.76	2.69	3.69	4.23	4.75	5.26	5.75	6.87	7.96	8.50	9.06	9.69	10.24	-	-	0.06	0.42	0.59	0.73
4600	1.77	2.71	3.73	4.28	4.81	5.32	5.82	6.94	8.03	8.56	9.12	9.73	10.26	-	-	0.07	0.43	0.60	0.74
4700	1.79	2.74	3.77	4.32	4.86	5.38	5.88	7.00	8.09	8.62	9.16	9.76	10.26	-	-	0.07	0.43	0.62	0.76
4800	1.80	2.77	3.81	4.37	4.91	5.43	5.93	7.06	8.14	8.67	9.20	9.78	-	-	-	0.07	0.44	0.63	0.78
4900	1.81	2.79	3.85	4.41	4.95	5.48	5.99	7.11	8.19	8.71	9.23	9.79	-	-	-	0.07	0.45	0.64	0.79
5000	1.82	2.82	3.88	4.45	5.00	5.53	6.04	7.16	8.23	8.74	9.25	9.79	-	-	-	0.07	0.46	0.66	0.81
5100	1.83	2.84	3.92	4.49	5.04	5.57	6.08	7.21	8.27	8.77	9.27	-	-	-	-	0.07	0.47	0.67	0.82
5200	1.84	2.86	3.95	4.52	5.08	5.61	6.12	7.25	8.30	8.79	9.27	-	-	-	-	0.07	0.48	0.68	0.84
5300	1.84	2.88	3.98	4.56	5.12	5.65	6.16	7.29	8.32	8.80	9.26	-	-	-	-	0.08	0.49	0.70	0.86
5400	1.85	2.89	4.00	4.59	5.15	5.69	6.20	7.32	8.34	8.80	9.25	-	-	-	-	0.08	0.50	0.71	0.87
5500	1.85	2.91	4.03	4.62	5.18	5.72	6.23	7.34	8.35	8.80	-	-	-	-	-	0.08	0.51	0.72	0.89
5600	1.86	2.92	4.05	4.65	5.21	5.75	6.26	7.36	8.35	8.78	-	-	-	-	-	0.08	0.52	0.74	0.90
5800	1.86	2.95	4.09	4.69	5.26	5.80	6.31	7.39	8.33	-	-	-	-	-	-	0.08	0.54	0.76	0.94
6000	1.86	2.97	4.13	4.73	5.30	5.83	6.34	7.40	8.29	-	-	-	-	-	-	0.09	0.56	0.79	0.97
6200	1.86	2.98	4.15	4.75	5.32	5.86	6.35	7.38	-	-	-	-	-	-	-	0.09	0.57	0.81	1.00
6400	1.85	2.99	4.16	4.77	5.34	5.86	6.35	7.34	-	-	-	-	-	-	-	0.09	0.59	0.84	1.03
6600	1.84	2.99	4.17	4.77	5.34	5.86	6.33	7.28	-	-	-	-	-	-	-	0.09	0.61	0.87	1.07
6800	1.82	2.98	4.17	4.77	5.32	5.83	6.30	7.19	-	-	-	-	-	-	-	0.10	0.63	0.89	1.10
7000	1.79	2.																	

SPZX(3VX)-Section Power Rating

Table 2-31

[kw]

small pulley speed nd(rpm)	Basic power rating for small pulley datum diameter : Ps															Additional power rating for speed ratio (Pa)			
	Small pulley datum diameter dd (mm)															Speed ratio			
	56	60	63	71	80	85	90	95	100	112	125	140	160	180	200	1.01 to 1.05	1.06 to 1.26	1.27 to 1.57	<1.57
700	0.63	0.73	0.81	1.00	1.22	1.34	1.46	1.58	1.70	1.99	2.29	2.63	3.08	3.53	3.97	0.01	0.06	0.08	0.10
950	0.80	0.93	1.03	1.29	1.58	1.74	1.90	2.05	2.21	2.58	2.98	3.43	4.02	4.60	5.17	0.01	0.08	0.11	0.13
1450	1.10	1.30	1.44	1.82	2.24	2.47	2.70	2.92	3.15	3.68	4.26	4.90	5.74	6.57	7.37	0.02	0.12	0.16	0.20
2850	1.78	2.13	2.38	3.06	3.81	4.22	4.62	5.02	5.41	6.33	7.30	8.38	9.74	11.01	12.19	0.04	0.23	0.32	0.40
100	0.13	0.14	0.16	0.19	0.23	0.25	0.27	0.29	0.31	0.36	0.41	0.47	0.55	0.63	0.70	0.00	0.01	0.01	0.01
200	0.23	0.26	0.28	0.35	0.42	0.46	0.50	0.53	0.57	0.66	0.76	0.87	1.02	1.17	1.31	0.00	0.02	0.02	0.03
300	0.32	0.37	0.40	0.49	0.59	0.65	0.71	0.76	0.82	0.95	1.09	1.25	1.46	1.67	1.88	0.00	0.02	0.03	0.04
400	0.40	0.46	0.51	0.63	0.76	0.83	0.91	0.98	1.05	1.22	1.40	1.61	1.89	2.16	2.43	0.00	0.03	0.05	0.06
500	0.48	0.56	0.61	0.76	0.92	1.01	1.10	1.19	1.27	1.48	1.71	1.96	2.30	2.63	2.96	0.01	0.04	0.06	0.07
600	0.56	0.65	0.71	0.88	1.07	1.18	1.28	1.39	1.49	1.74	2.00	2.30	2.70	3.09	3.47	0.01	0.05	0.07	0.08
700	0.63	0.73	0.81	1.00	1.22	1.34	1.46	1.58	1.70	1.99	2.29	2.63	3.08	3.53	3.97	0.01	0.06	0.08	0.10
800	0.70	0.81	0.90	1.12	1.37	1.50	1.64	1.77	1.91	2.23	2.57	2.95	3.46	3.96	4.46	0.01	0.06	0.09	0.11
900	0.77	0.89	0.99	1.24	1.51	1.66	1.81	1.96	2.11	2.46	2.84	3.27	3.83	4.39	4.93	0.01	0.07	0.10	0.13
1000	0.83	0.97	1.07	1.35	1.65	1.81	1.98	2.14	2.31	2.69	3.11	3.58	4.20	4.80	5.40	0.01	0.08	0.11	0.14
1100	0.90	1.05	1.16	1.46	1.78	1.96	2.14	2.32	2.50	2.92	3.37	3.88	4.55	5.21	5.85	0.01	0.09	0.12	0.15
1200	0.96	1.12	1.24	1.56	1.92	2.11	2.31	2.50	2.69	3.14	3.63	4.18	4.90	5.61	6.30	0.01	0.10	0.14	0.17
1300	1.02	1.19	1.32	1.67	2.05	2.26	2.46	2.67	2.88	3.36	3.88	4.47	5.24	6.00	6.73	0.02	0.10	0.15	0.18
1400	1.07	1.26	1.40	1.77	2.17	2.40	2.62	2.84	3.06	3.58	4.13	4.76	5.58	6.38	7.16	0.02	0.11	0.16	0.20
1500	1.13	1.33	1.48	1.87	2.30	2.54	2.77	3.01	3.24	3.79	4.38	5.04	5.91	6.75	7.57	0.02	0.12	0.17	0.21
1600	1.19	1.40	1.55	1.97	2.42	2.67	2.92	3.17	3.42	4.00	4.62	5.32	6.23	7.12	7.98	0.02	0.13	0.18	0.22
1700	1.24	1.46	1.63	2.06	2.54	2.81	3.07	3.33	3.59	4.20	4.85	5.59	6.55	7.48	8.38	0.02	0.14	0.19	0.24
1800	1.29	1.53	1.70	2.16	2.66	2.94	3.22	3.49	3.76	4.40	5.09	5.86	6.86	7.83	8.76	0.02	0.14	0.20	0.25
1900	1.34	1.59	1.77	2.25	2.78	3.07	3.36	3.65	3.93	4.60	5.32	6.12	7.16	8.17	9.14	0.02	0.15	0.22	0.27
2000	1.39	1.65	1.84	2.34	2.90	3.20	3.50	3.80	4.10	4.80	5.54	6.38	7.46	8.50	9.51	0.02	0.16	0.23	0.28
2100	1.44	1.71	1.91	2.43	3.01	3.33	3.64	3.95	4.26	4.99	5.76	6.63	7.75	8.83	9.86	0.03	0.17	0.24	0.29
2200	1.49	1.77	1.97	2.52	3.12	3.45	3.78	4.10	4.42	5.18	5.98	6.88	8.04	9.15	10.21	0.03	0.18	0.25	0.31
2300	1.54	1.83	2.04	2.61	3.23	3.57	3.91	4.25	4.58	5.37	6.19	7.12	8.32	9.46	10.55	0.03	0.18	0.26	0.32
2400	1.58	1.88	2.11	2.69	3.34	3.69	4.05	4.39	4.74	5.55	6.40	7.36	8.59	9.76	10.87	0.03	0.19	0.27	0.33
2500	1.63	1.94	2.17	2.78	3.45	3.81	4.18	4.54	4.89	5.73	6.61	7.60	8.86	10.05	11.18	0.03	0.20	0.28	0.35
2600	1.67	1.99	2.23	2.86	3.55	3.93	4.31	4.68	5.04	5.90	6.81	7.83	9.12	10.34	11.49	0.03	0.21	0.30	0.36
2700	1.72	2.05	2.29	2.94	3.66	4.05	4.43	4.81	5.19	6.08	7.01	8.05	9.37	10.61	11.78	0.03	0.22	0.31	0.38
2800	1.76	2.10	2.35	3.02	3.76	4.16	4.56	4.95	5.34	6.25	7.21	8.27	9.62	10.88	12.05	0.03	0.22	0.32	0.39
2900	1.80	2.15	2.41	3.10	3.86	4.27	4.68	5.08	5.48	6.42	7.40	8.48	9.86	11.14	12.32	0.04	0.23	0.33	0.40
3000	1.84	2.20	2.47	3.18	3.96	4.38	4.80	5.22	5.62	6.58	7.58	8.69	10.09	11.39	12.58	0.04	0.24	0.34	0.42
3100	1.88	2.25	2.53	3.25	4.05	4.49	4.92	5.34	5.76	6.74	7.77	8.90	10.31	11.62	12.82	0.04	0.25	0.35	0.43
3200	1.92	2.30	2.58	3.33	4.15	4.60	5.04	5.47	5.90	6.90	7.95	9.10	10.53	11.85	13.05	0.04	0.26	0.36	0.45
3300	1.95	2.35	2.64	3.40	4.24	4.70	5.15	5.60	6.03	7.06	8.12	9.29	10.74	12.07	13.26	0.04	0.26	0.37	0.46
3400	1.99	2.39	2.69	3.48	4.34	4.80	5.27	5.72	6.17	7.21	8.29	9.48	10.95	12.28	13.47	0.04	0.27	0.39	0.47
3500	2.03	2.44	2.75	3.55	4.43	4.91	5.38	5.84	6.30	7.36	8.46	9.66	11.14	12.48	13.66	0.04	0.28	0.40	0.49
3600	2.06	2.49	2.80	3.62	4.52	5.01	5.49	5.96	6.42	7.50	8.62	9.84	11.33	12.67	13.83	0.04	0.29	0.41	0.50
3700	2.10	2.53	2.85	3.69	4.60	5.10	5.59	6.07	6.55	7.65	8.78	10.01	11.51	12.85	13.99	0.05	0.30	0.42	0.52
3800	2.13	2.57	2.90	3.75	4.69	5.20	5.70	6.19	6.67	7.79	8.94	10.18	11.69	13.01	14.14	0.05	0.30	0.43	0.53
3900	2.16	2.61	2.95	3.82	4.78	5.29	5.80	6.30	6.79	7.92	9.09	10.34	11.85	13.17	-	0.05	0.31	0.44	0.54
4000	2.20	2.66	3.00	3.89	4.86	5.39	5.90	6.41	6.91	8.06	9.23	10.49	12.01	13.31	-	0.05	0.32	0.45	0.56
4100	2.23	2.70	3.04	3.95	4.94	5.48	6.00	6.52	7.02	8.19	9.37	10.64	12.16	13.45	-	0.05	0.33	0.47	0.57
4200	2.26	2.74	3.09	4.01	5.02	5.57	6.10	6.62	7.13	8.31	9.51	10.79	12.30	13.57	-	0.05	0.34	0.48	0.59
4300	2.29	2.77	3.14	4.08	5.10	5.65	6.19	6.72	7.24	8.43	9.64	10.92	12.43	-	-	0.05	0.34	0.49	0.60
4400	2.32	2.81	3.18	4.14	5.18	5.74	6.29	6.82	7.35	8.55	9.77	11.05	12.55	-	-	0.05	0.35	0.50	0.61
4500	2.35	2.85	3.22	4.20	5.25	5.82	6.38	6.92	7.45	8.67	9.89	11.18	12.66	-	-	0.06	0.36	0.51	0.63
4600	2.37	2.89	3.27	4.25	5.33	5.90	6.47	7.02	7.55	8.78	10.01	11.30	12.77	-	-	0.06	0.37	0.52	0.64
4700	2.40	2.92	3.31	4.31	5.40	5.98	6.55	7.11	7.65	8.89	10.13	11.41	12.86	-	-	0.06	0.38	0.53	0.66
4800	2.43	2.96	3.35	4.37	5.47	6.06	6.64	7.20	7.75	8.99	10.24	11.52	-	-	-	0.06	0.38	0.54	0.67
4900	2.45	2.99	3.39	4.42	5.54	6.14	6.72	7.29	7.84	9.10	10.34	11.61	-	-	-	0.06	0.39	0.56	0.68
5000	2.48	3.02	3.43	4.47	5.60	6.21	6.80	7.37	7.93	9.19	10.44	11.71	-	-	-	0.06	0.40	0.57	0.70
5100	2.50	3.05	3.46	4.53	5.67	6.28	6.88	7.46	8.02	9.29	10.53	11.79	-	-	-	0.06	0.41	0.58	0.71
5200	2.52	3.08	3.50	4.58	5.73	6.35	6.96	7.54	8.10	9.38	10.62	11.87	-	-	-	0.06	0.42	0.59	0.73
5300	2.55	3.11	3.54	4.63	5.80	6.42	7.03	7.62	8.18	9.46	10.71	11.94	-	-	-	0.07	0.42	0.60	0.74
5400	2.57	3.14	3.57	4.67	5.86	6.49	7.10	7.69	8.26	9.55	10.78	12.01	-	-	-	0.07	0.43	0.61	0.75
5500	2.59	3.17	3.60	4.72	5.92	6.55	7.17	7.77	8.34	9.62	10.86	-	-	-	-	0.07	0.44	0.62	0.77
5600	2.61	3.20	3.64	4.77	5.97	6.62	7.24	7.84	8.41	9.70	10.93	-	-	-	-	0.07	0.45	0.64	0.78
5800	2.64	3.25	3.70	4.85	6.08	6.74	7.37	7.97	8.55	9.83	11.05	-	-	-	-	0.07	0.46	0.66	0.81
6000	2.68	3.30	3.76	4.93	6.19	6.85	7.48	8.09	8.67	9.95	11.14	-	-	-	-	0.07	0.48	0.68	0.84
6200	2.71	3.35	3.81	5.01	6.28	6.95	7.59	8.20	8.79	10.06	-	-	-	-	-	0.08	0.50	0.70	0.87
6400	2.74	3.39	3.86	5.08	6.37	7.05	7.69	8.30	8.89	10.14	-	-	-	-	-	0.08	0.51	0.73	0.89
6600	2.76	3.43	3.91	5.15	6.45	7.13	7.78	8.39	8.97	10.21	-	-	-	-	-	0.08	0.53	0.75	0.92
6800	2.79	3.46	3.95	5.21	6.53														

SPAX-Section Power Rating

Table 2-33

[kw]

small pulley speed nd(rpm)	Basic power rating for small pulley datum diameter : Ps															Additional power rating for speed ratio (Pa)			
	Small pulley datum diameter dd (mm)															Speed ratio			
	71	75	80	90	100	112	118	125	140	160	180	200	224	250	280	1.01 to 1.05	1.06 to 1.26	1.27 to 1.57	< 1.57
700	0.98	1.14	1.35	1.76	2.17	2.66	2.90	3.18	3.78	4.57	5.36	6.13	7.06	8.04	9.17	0.02	0.13	0.19	0.23
950	1.25	1.47	1.75	2.29	2.84	3.49	3.81	4.18	4.97	6.02	7.06	8.08	9.29	10.59	12.05	0.03	0.18	0.26	0.31
1450	1.75	2.08	2.48	3.29	4.10	5.05	5.52	6.07	7.23	8.76	10.26	11.73	13.45	15.27	17.30	0.04	0.27	0.39	0.48
2850	2.88	3.49	4.24	5.71	7.16	8.86	9.70	10.66	12.67	15.23	17.65	19.92	22.43	24.85	-	0.08	0.54	0.77	0.94
100	0.19	0.21	0.25	0.31	0.38	0.46	0.49	0.54	0.64	0.76	0.89	1.02	1.17	1.33	1.51	0.00	0.02	0.03	0.03
200	0.34	0.39	0.46	0.58	0.71	0.86	0.93	1.02	1.20	1.45	1.69	1.94	2.22	2.53	2.89	0.01	0.04	0.05	0.07
300	0.48	0.56	0.65	0.83	1.02	1.24	1.35	1.48	1.75	2.11	2.46	2.82	3.24	3.69	4.21	0.01	0.06	0.08	0.10
400	0.61	0.71	0.83	1.08	1.32	1.61	1.75	1.92	2.27	2.74	3.21	3.67	4.22	4.82	5.50	0.01	0.08	0.11	0.13
500	0.74	0.86	1.01	1.31	1.61	1.96	2.14	2.35	2.79	3.37	3.94	4.51	5.19	5.92	6.75	0.01	0.09	0.13	0.17
600	0.86	1.00	1.18	1.54	1.89	2.31	2.52	2.77	3.29	3.97	4.65	5.33	6.13	6.99	7.97	0.02	0.11	0.16	0.20
700	0.98	1.14	1.35	1.76	2.17	2.66	2.90	3.18	3.78	4.57	5.36	6.13	7.06	8.04	9.17	0.02	0.13	0.19	0.23
800	1.09	1.28	1.51	1.98	2.44	2.99	3.27	3.58	4.26	5.16	6.04	6.92	7.96	9.08	10.34	0.02	0.15	0.22	0.26
900	1.20	1.41	1.67	2.19	2.71	3.32	3.63	3.98	4.74	5.74	6.72	7.70	8.85	10.09	11.49	0.03	0.17	0.24	0.30
1000	1.30	1.54	1.82	2.40	2.97	3.65	3.98	4.38	5.21	6.31	7.39	8.46	9.73	11.08	12.61	0.03	0.19	0.27	0.33
1100	1.41	1.66	1.98	2.60	3.23	3.97	4.33	4.76	5.67	6.87	8.05	9.21	10.58	12.05	13.70	0.03	0.21	0.30	0.36
1200	1.51	1.78	2.12	2.81	3.48	4.28	4.68	5.14	6.12	7.42	8.69	9.94	11.43	13.00	14.77	0.04	0.23	0.32	0.40
1300	1.61	1.90	2.27	3.00	3.73	4.59	5.02	5.52	6.57	7.96	9.32	10.67	12.25	13.92	15.80	0.04	0.25	0.35	0.43
1400	1.70	2.02	2.41	3.20	3.98	4.90	5.36	5.89	7.01	8.49	9.95	11.38	13.06	14.83	16.81	0.04	0.27	0.38	0.46
1500	1.80	2.13	2.55	3.39	4.22	5.20	5.69	6.25	7.45	9.02	10.56	12.07	13.84	15.71	17.79	0.04	0.28	0.40	0.50
1600	1.89	2.25	2.69	3.58	4.46	5.50	6.01	6.61	7.88	9.54	11.16	12.75	14.61	16.57	18.73	0.05	0.30	0.43	0.53
1700	1.98	2.36	2.83	3.77	4.69	5.79	6.33	6.96	8.30	10.05	11.75	13.42	15.36	17.40	19.64	0.05	0.32	0.46	0.56
1800	2.07	2.47	2.96	3.95	4.92	6.08	6.65	7.31	8.72	10.55	12.33	14.07	16.10	18.20	20.52	0.05	0.34	0.48	0.60
1900	2.15	2.57	3.09	4.13	5.15	6.36	6.96	7.66	9.13	11.04	12.90	14.71	16.81	18.98	21.36	0.06	0.36	0.51	0.63
2000	2.24	2.68	3.22	4.31	5.38	6.65	7.27	8.00	9.53	11.52	13.46	15.33	17.50	19.73	22.16	0.06	0.38	0.54	0.66
2100	2.32	2.78	3.35	4.48	5.60	6.92	7.58	8.33	9.92	11.99	14.00	15.94	18.17	20.46	22.92	0.06	0.40	0.56	0.69
2200	2.40	2.88	3.48	4.66	5.82	7.19	7.87	8.66	10.31	12.46	14.53	16.53	18.82	21.15	23.64	0.06	0.42	0.59	0.73
2300	2.48	2.98	3.60	4.83	6.03	7.46	8.17	8.98	10.69	12.91	15.05	17.10	19.44	21.81	24.32	0.07	0.44	0.62	0.76
2400	2.56	3.07	3.72	4.99	6.25	7.73	8.46	9.30	11.07	13.36	15.55	17.66	20.04	22.44	24.96	0.07	0.45	0.65	0.79
2500	2.63	3.17	3.84	5.16	6.46	7.99	8.74	9.61	11.44	13.79	16.05	18.19	20.62	23.04	25.55	0.07	0.47	0.67	0.83
2600	2.71	3.26	3.95	5.32	6.66	8.24	9.02	9.92	11.80	14.22	16.52	18.71	21.17	23.60	26.09	0.08	0.49	0.70	0.86
2700	2.78	3.35	4.07	5.48	6.86	8.49	9.30	10.22	12.15	14.63	16.99	19.21	21.69	24.13	26.59	0.08	0.51	0.73	0.89
2800	2.85	3.44	4.18	5.63	7.06	8.74	9.56	10.51	12.50	15.03	17.44	19.69	22.19	24.62	-	0.08	0.53	0.75	0.93
2900	2.92	3.53	4.29	5.79	7.26	8.98	9.83	10.80	12.84	15.43	17.87	20.15	22.66	25.08	-	0.08	0.55	0.78	0.96
3000	2.99	3.62	4.40	5.94	7.45	9.22	10.09	11.09	13.17	15.81	18.29	20.59	23.11	25.49	-	0.09	0.57	0.81	0.99
3100	3.05	3.70	4.50	6.09	7.64	9.45	10.34	11.36	13.49	16.18	18.69	21.01	23.52	-	-	0.09	0.59	0.83	1.03
3200	3.11	3.78	4.61	6.23	7.82	9.68	10.59	11.63	13.80	16.53	19.08	21.41	23.91	-	-	0.09	0.61	0.86	1.06
3300	3.18	3.86	4.71	6.38	8.00	9.91	10.84	11.90	14.11	16.88	19.45	21.78	24.26	-	-	0.10	0.63	0.89	1.09
3400	3.24	3.94	4.81	6.52	8.18	10.13	11.07	12.16	14.40	17.21	19.80	22.14	24.58	-	-	0.10	0.64	0.91	1.12
3500	3.30	4.02	4.91	6.65	8.36	10.34	11.31	12.41	14.69	17.53	20.13	22.47	-	-	-	0.10	0.66	0.94	1.16
3600	3.35	4.09	5.00	6.79	8.53	10.55	11.53	12.66	14.97	17.84	20.45	22.77	-	-	-	0.11	0.68	0.97	1.19
3700	3.41	4.16	5.09	6.92	8.69	10.75	11.75	12.90	15.24	18.14	20.75	23.05	-	-	-	0.11	0.70	0.99	1.22
3800	3.46	4.23	5.18	7.05	8.86	10.95	11.97	13.13	15.50	18.42	21.03	23.31	-	-	-	0.11	0.72	1.02	1.26
3900	3.52	4.30	5.27	7.17	9.01	11.15	12.18	13.35	15.75	18.69	21.30	-	-	-	-	0.11	0.74	1.05	1.29
4000	3.57	4.37	5.36	7.29	9.17	11.34	12.38	13.57	15.99	18.94	21.54	-	-	-	-	0.12	0.76	1.08	1.32
4100	3.61	4.43	5.44	7.41	9.32	11.52	12.58	13.78	16.23	19.18	21.76	-	-	-	-	0.12	0.78	1.10	1.36
4200	3.66	4.50	5.52	7.53	9.47	11.70	12.77	13.98	16.45	19.41	21.96	-	-	-	-	0.12	0.80	1.13	1.39
4300	3.71	4.56	5.60	7.64	9.61	11.87	12.95	14.18	16.66	19.62	-	-	-	-	-	0.13	0.81	1.16	1.42
4400	3.75	4.61	5.68	7.75	9.75	12.04	13.13	14.37	16.86	19.82	-	-	-	-	-	0.13	0.83	1.18	1.45
4500	3.79	4.67	5.75	7.86	9.88	12.20	13.30	14.55	17.05	20.00	-	-	-	-	-	0.13	0.85	1.21	1.49
4600	3.83	4.73	5.82	7.96	10.01	12.35	13.47	14.72	17.23	20.16	-	-	-	-	-	0.13	0.87	1.24	1.52
4700	3.87	4.78	5.89	8.06	10.14	12.50	13.63	14.89	17.40	20.31	-	-	-	-	-	0.14	0.89	1.26	1.55
4800	3.91	4.83	5.96	8.16	10.26	12.64	13.78	15.05	17.56	-	-	-	-	-	-	0.14	0.91	1.29	1.59
4900	3.94	4.88	6.03	8.25	10.38	12.78	13.92	15.19	17.71	-	-	-	-	-	-	0.14	0.93	1.32	1.62
5000	3.97	4.92	6.09	8.34	10.49	12.91	14.06	15.33	17.84	-	-	-	-	-	-	0.15	0.95	1.34	1.65
5100	4.00	4.97	6.15	8.43	10.60	13.04	14.19	15.47	17.97	-	-	-	-	-	-	0.15	0.97	1.37	1.69
5200	4.03	5.01	6.20	8.51	10.70	13.16	14.31	15.59	18.08	-	-	-	-	-	-	0.15	0.99	1.40	1.72
5300	4.06	5.05	6.26	8.59	10.80	13.27	14.42	15.70	18.18	-	-	-	-	-	-	0.16	1.00	1.43	1.75
5400	4.08	5.08	6.31	8.67	10.89	13.37	14.53	15.81	18.27	-	-	-	-	-	-	0.16	1.02	1.45	1.79
5500	4.11	5.12	6.36	8.74	10.98	13.47	14.63	15.91	-	-	-	-	-	-	-	0.16	1.04	1.48	1.82
5600	4.13	5.15	6.40	8.81	11.06	13.56	14.72	15.99	-	-	-	-	-	-	-	0.16	1.06	1.51	1.85
5700	4.15	5.18	6.45	8.87	11.14	13.65	14.81	16.07	-	-	-	-	-	-	-	0.17	1.08	1.53	1.88
5800	4.16	5.21	6.49	8.93	11.22	13.73	14.88	16.14	-	-	-	-	-	-	-	0.17	1.10	1.56	1.92
5900	4.18	5.24	6.53	8.99	11.28	13.80	14.95	16.20	-	-	-	-	-	-	-	0.17	1.12	1.59	1.95
6000	4.19	5.26	6.56	9.04	11.35	13.86	15.01	16.25	-	-	-	-	-	-	-	0.18	1.14	1.61	1.98
6100	4.20	5.28	6.59	9.09	11.41	13.92	15.06	16.29	-	-	-	-	-	-	-	0.18	1.16	1.64	2.02
6200	4.21	5.30	6.62	9.14	11.46	13.97	15.10	-	-	-	-	-	-	-	-	0.18	1.17	1.67	2.05
6300	4.22	5.32	6.65																

SPB-Section Power Rating

Table 2-34

[kw]

small pulley speed nd(rpm)	Basic power rating for small pulley datum diameter : Ps															Additional power rating for speed ratio (Pa)			
	Small pulley datum diameter dd (mm)															Speed ratio			
	140	150	160	180	190	200	212	224	236	250	280	315	355	375	400	1.01 to 1.05	1.06 to 1.26	1.27 to 1.57	1.57<
700	3.44	4.02	4.59	5.73	6.29	6.85	7.52	8.18	8.84	9.60	11.22	13.07	15.13	16.15	17.40	0.05	0.33	0.46	0.57
950	4.40	5.16	5.91	7.40	8.14	8.87	9.74	10.60	11.45	12.44	14.51	16.86	19.46	20.71	22.25	0.07	0.44	0.63	0.77
1450	6.08	7.17	8.25	10.37	11.41	12.44	13.65	14.84	16.01	17.35	20.11	23.13	26.32	27.80	29.53	0.10	0.67	0.96	1.18
2850	9.09	10.84	12.51	15.65	17.11	18.49	20.03	21.45	22.73	24.06	--	--	--	--	--	0.20	1.32	1.88	2.31
100	0.66	0.75	0.85	1.03	1.13	1.22	1.33	1.44	1.55	1.68	1.95	2.27	2.63	2.81	3.03	0.01	0.05	0.07	0.08
200	1.20	1.38	1.56	1.92	2.10	2.27	2.49	2.70	2.91	3.15	3.67	4.28	4.96	5.30	5.72	0.01	0.09	0.13	0.16
300	1.70	1.96	2.22	2.75	3.01	3.26	3.57	3.88	4.19	4.54	5.30	6.18	7.16	7.66	8.27	0.02	0.14	0.20	0.24
400	2.16	2.51	2.85	3.53	3.87	4.21	4.61	5.01	5.41	5.87	6.86	7.99	9.28	9.91	10.70	0.03	0.19	0.26	0.32
500	2.61	3.03	3.45	4.29	4.71	5.12	5.61	6.10	6.59	7.16	8.36	9.75	11.31	12.08	13.03	0.04	0.23	0.33	0.41
600	3.03	3.53	4.03	5.02	5.51	6.00	6.58	7.16	7.73	8.40	9.81	11.44	13.26	14.16	15.27	0.04	0.28	0.40	0.49
700	3.44	4.02	4.59	5.73	6.29	6.85	7.52	8.18	8.84	9.60	11.22	13.07	15.13	16.15	17.40	0.05	0.33	0.46	0.57
800	3.84	4.49	5.13	6.41	7.05	7.68	8.43	9.17	9.91	10.77	12.57	14.63	16.92	18.05	19.42	0.06	0.37	0.53	0.65
900	4.22	4.94	5.66	7.08	7.78	8.48	9.31	10.13	10.95	11.89	13.88	16.13	18.63	19.85	21.34	0.06	0.42	0.59	0.73
1000	4.58	5.38	6.17	7.72	8.49	9.25	10.16	11.06	11.95	12.97	15.13	17.57	20.25	21.55	23.13	0.07	0.46	0.66	0.81
1100	4.94	5.80	6.66	8.35	9.18	10.01	10.99	11.96	12.92	14.02	16.33	18.94	21.78	23.15	24.80	0.08	0.51	0.73	0.89
1200	5.28	6.21	7.13	8.95	9.85	10.73	11.78	12.82	13.85	15.02	17.48	20.23	23.21	24.63	26.34	0.09	0.56	0.79	0.97
1300	5.61	6.61	7.59	9.54	10.49	11.43	12.55	13.65	14.74	15.99	18.58	21.45	24.54	25.99	27.73	0.09	0.60	0.86	1.05
1400	5.93	6.99	8.04	10.10	11.11	12.11	13.29	14.45	15.60	16.90	19.61	22.59	25.76	27.23	28.97	0.10	0.65	0.92	1.13
1500	6.23	7.36	8.47	10.64	11.71	12.76	14.00	15.22	16.41	17.78	20.58	23.65	26.86	28.33	30.04	0.11	0.70	0.99	1.22
1600	6.53	7.71	8.88	11.16	12.28	13.38	14.68	15.94	17.19	18.60	21.49	24.62	27.83	29.29	30.95	0.11	0.74	1.05	1.30
1700	6.81	8.05	9.27	11.66	12.83	13.97	15.32	16.64	17.92	19.38	22.34	25.50	28.69	30.10	31.68	0.12	0.79	1.12	1.38
1800	7.08	8.38	9.65	12.14	13.35	14.54	15.93	17.29	18.61	20.10	23.11	26.28	29.40	30.75	32.22	0.13	0.84	1.19	1.46
1900	7.33	8.69	10.01	12.60	13.85	15.07	16.51	17.90	19.25	20.77	23.81	26.96	29.98	31.24	32.56	0.14	0.88	1.25	1.54
2000	7.58	8.98	10.36	13.03	14.32	15.58	17.05	18.47	19.85	21.38	24.43	27.53	30.41	31.55	-	0.14	0.93	1.32	1.62
2100	7.81	9.26	10.68	13.44	14.76	16.05	17.55	19.00	20.39	21.94	24.98	28.00	30.68	-	-	0.15	0.98	1.38	1.70
2200	8.02	9.53	10.99	13.82	15.17	16.49	18.02	19.48	20.89	22.44	25.44	28.35	-	-	-	0.16	1.02	1.45	1.78
2300	8.23	9.77	11.28	14.18	15.56	16.90	18.44	19.92	21.33	22.87	25.82	28.58	-	-	-	0.17	1.07	1.52	1.86
2400	8.42	10.01	11.55	14.51	15.91	17.27	18.83	20.31	21.72	23.25	26.11	28.69	-	-	-	0.17	1.11	1.58	1.95
2500	8.59	10.22	11.80	14.81	16.24	17.61	19.17	20.66	22.05	23.55	26.31	-	-	-	-	0.18	1.16	1.65	2.03
2600	8.76	10.42	12.03	15.09	16.53	17.91	19.48	20.95	22.32	23.79	26.41	-	-	-	-	0.19	1.21	1.71	2.11
2700	8.90	10.60	12.24	15.34	16.79	18.17	19.73	21.19	22.53	23.95	26.42	-	-	-	-	0.19	1.25	1.78	2.19
2800	9.03	10.76	12.43	15.55	17.01	18.39	19.94	21.37	22.68	24.04	-	-	-	-	-	0.20	1.30	1.85	2.27
2900	9.15	10.91	12.59	15.74	17.20	18.57	20.10	21.50	22.77	24.06	-	-	-	-	-	0.21	1.35	1.91	2.35
3000	9.25	11.03	12.74	15.90	17.35	18.71	20.22	21.58	22.79	24.00	-	-	-	-	-	0.22	1.39	1.98	2.43
3100	9.34	11.14	12.86	16.03	17.47	18.81	20.28	21.59	22.74	-	-	-	-	-	-	0.22	1.44	2.04	2.51
3200	9.41	11.23	12.96	16.12	17.55	18.87	20.29	21.55	22.62	-	-	-	-	-	-	0.23	1.49	2.11	2.59
3300	9.46	11.29	13.03	16.18	17.59	18.88	20.25	21.44	-	-	-	-	-	-	-	0.24	1.53	2.18	2.68
3400	9.49	11.34	13.08	16.21	17.59	18.84	20.16	21.27	-	-	-	-	-	-	-	0.24	1.58	2.24	2.76
3500	9.51	11.36	13.10	16.20	17.55	18.76	20.01	-	-	-	-	-	-	-	-	0.25	1.63	2.31	2.84
3600	9.51	11.37	13.10	16.15	17.47	18.62	19.80	-	-	-	-	-	-	-	-	0.26	1.67	2.37	2.92
3700	9.49	11.35	13.07	16.07	17.34	18.44	-	-	-	-	-	-	-	-	-	0.27	1.72	2.44	3.00
3800	9.46	11.31	13.02	15.96	17.17	18.21	-	-	-	-	-	-	-	-	-	0.27	1.76	2.50	3.08
3900	9.40	11.25	12.93	15.80	16.96	-	-	-	-	-	-	-	-	-	-	0.28	1.81	2.57	3.16
4000	9.32	11.16	12.82	15.60	16.70	-	-	-	-	-	-	-	-	-	-	0.29	1.86	2.64	3.24
4100	9.23	11.05	12.68	15.37	-	-	-	-	-	-	-	-	-	-	-	0.29	1.90	2.70	3.32
4200	9.11	10.91	12.51	15.09	-	-	-	-	-	-	-	-	-	-	-	0.30	1.95	2.77	3.40
4300	8.98	10.75	12.31	-	-	-	-	-	-	-	-	-	-	-	-	0.31	2.00	2.83	3.49
4400	8.82	10.57	12.09	-	-	-	-	-	-	-	-	-	-	-	-	0.32	2.04	2.90	3.57
4500	8.64	10.35	11.82	-	-	-	-	-	-	-	-	-	-	-	-	0.32	2.09	2.97	3.65
4600	8.45	10.12	11.53	-	-	-	-	-	-	-	-	-	-	-	-	0.33	2.14	3.03	3.73
4700	8.22	9.85	11.21	-	-	-	-	-	-	-	-	-	-	-	-	0.34	2.18	3.10	3.81
4800	7.98	9.56	-	-	-	-	-	-	-	-	-	-	-	-	-	0.34	2.23	3.16	3.89
4900	7.71	9.24	-	-	-	-	-	-	-	-	-	-	-	-	-	0.35	2.28	3.23	3.97
5000	7.42	8.89	-	-	-	-	-	-	-	-	-	-	-	-	-	0.36	2.32	3.30	4.05
5100	7.11	-	-	-	-	-	-	-	-	-	-	-	-	-	-	0.37	2.37	3.36	4.13
5200	6.77	-	-	-	-	-	-	-	-	-	-	-	-	-	-	0.37	2.41	3.43	4.22
5300	6.41	-	-	-	-	-	-	-	-	-	-	-	-	-	-	0.38	2.46	3.49	4.30
5400	6.02	-	-	-	-	-	-	-	-	-	-	-	-	-	-	0.39	2.51	3.56	4.38
5500	-	-	-	-	-	-	-	-	-	-	-	-	-	-	-	0.40	2.55	3.63	4.46

Light blue background: Belt speed is over 30 m/sec. to 35 m/sec. Please consult our sales company or Engineering Department.

Dark blue background: Belt speed is over 35 m/sec. to 40 m/sec. Please consult our sales company or Engineering Department.



SPBX(5VX)-Section Power Rating

Table 2-35

[kw]

small pulley speed nd(rpm)	Basic power rating for small pulley datum diameter : Ps															Additional power rating for speed ratio (Pa)			
	Small pulley datum diameter dd (mm)															Speed ratio			
	112	118	125	132	140	150	160	180	200	224	250	280	315	355	400	1.01 to 1.05	1.06 to 1.26	1.27 to 1.57	1.57<
700	2.87	3.26	3.71	4.16	4.68	5.32	5.96	7.24	8.50	10.01	11.64	13.50	15.65	18.07	20.76	0.04	0.29	0.41	0.50
950	3.79	4.31	4.91	5.52	6.21	7.07	7.92	9.62	11.31	13.31	15.46	17.91	20.72	23.87	27.33	0.06	0.39	0.55	0.68
1450	5.53	6.30	7.20	8.10	9.12	10.39	11.65	14.15	16.61	19.52	22.60	26.06	29.97	34.25	38.79	0.09	0.59	0.84	1.04
2850	9.74	11.15	12.78	14.38	16.20	18.42	20.60	24.81	28.80	33.28	37.70	-	-	-	-	0.18	1.17	1.65	2.04
100	0.48	0.54	0.61	0.67	0.75	0.85	0.95	1.14	1.34	1.57	1.82	2.11	2.45	2.83	3.26	0.01	0.04	0.06	0.07
200	0.91	1.02	1.16	1.29	1.45	1.64	1.83	2.21	2.59	3.05	3.54	4.11	4.76	5.51	6.35	0.01	0.08	0.12	0.14
300	1.32	1.49	1.69	1.89	2.12	2.40	2.69	3.25	3.82	4.49	5.22	6.05	7.02	8.12	9.35	0.02	0.12	0.17	0.21
400	1.72	1.95	2.21	2.47	2.78	3.15	3.53	4.27	5.01	5.90	6.86	7.96	9.23	10.68	12.30	0.03	0.16	0.23	0.29
500	2.11	2.39	2.72	3.05	3.42	3.89	4.35	5.27	6.19	7.29	8.48	9.84	11.41	13.19	15.18	0.03	0.20	0.29	0.36
600	2.49	2.83	3.22	3.61	4.05	4.61	5.16	6.26	7.36	8.66	10.07	11.68	13.55	15.66	18.00	0.04	0.25	0.35	0.43
700	2.87	3.26	3.71	4.16	4.68	5.32	5.96	7.24	8.50	10.01	11.64	13.50	15.65	18.07	20.76	0.04	0.29	0.41	0.50
800	3.24	3.68	4.20	4.71	5.30	6.03	6.75	8.20	9.64	11.35	13.19	15.29	17.71	20.43	23.45	0.05	0.33	0.46	0.57
900	3.61	4.10	4.68	5.25	5.91	6.72	7.53	9.15	10.75	12.66	14.71	17.04	19.73	22.74	26.06	0.06	0.37	0.52	0.64
1000	3.97	4.51	5.15	5.78	6.51	7.41	8.31	10.09	11.85	13.95	16.20	18.76	21.70	24.99	28.59	0.06	0.41	0.58	0.71
1100	4.32	4.92	5.62	6.31	7.10	8.09	9.07	11.01	12.94	15.23	17.67	20.45	23.63	27.17	31.03	0.07	0.45	0.64	0.79
1200	4.67	5.32	6.08	6.83	7.69	8.76	9.82	11.93	14.01	16.48	19.12	22.10	25.51	29.29	33.38	0.08	0.49	0.70	0.86
1300	5.02	5.72	6.53	7.34	8.27	9.42	10.56	12.83	15.06	17.71	20.53	23.72	27.34	31.33	35.62	0.08	0.53	0.75	0.93
1400	5.36	6.11	6.98	7.85	8.84	10.07	11.29	13.71	16.10	18.92	21.92	25.29	29.11	33.30	37.76	0.09	0.57	0.81	1.00
1500	5.69	6.49	7.42	8.35	9.40	10.71	12.01	14.59	17.12	20.11	23.27	26.82	30.82	35.18	39.79	0.09	0.61	0.87	1.07
1600	6.02	6.87	7.86	8.84	9.96	11.35	12.73	15.45	18.12	21.27	24.59	28.31	32.48	36.98	41.70	0.10	0.65	0.93	1.14
1700	6.35	7.25	8.29	9.33	10.51	11.97	13.43	16.29	19.11	22.41	25.88	29.75	34.06	38.69	43.47	0.11	0.70	0.99	1.21
1800	6.67	7.62	8.72	9.81	11.05	12.59	14.12	17.12	20.07	23.51	27.13	31.14	35.58	40.30	45.11	0.11	0.74	1.05	1.29
1900	6.99	7.98	9.14	10.28	11.58	13.20	14.79	17.94	21.01	24.60	28.35	32.49	37.03	41.81	46.61	0.12	0.78	1.10	1.36
2000	7.30	8.34	9.55	10.75	12.11	13.79	15.46	18.74	21.93	25.65	29.52	33.77	38.40	43.22	-	0.13	0.82	1.16	1.43
2100	7.61	8.69	9.95	11.21	12.62	14.38	16.12	19.52	22.83	26.67	30.66	35.00	39.70	44.51	-	0.13	0.86	1.22	1.50
2200	7.91	9.04	10.35	11.66	13.13	14.96	16.76	20.29	23.71	27.67	31.75	36.18	40.91	-	-	0.14	0.90	1.28	1.57
2300	8.20	9.38	10.75	12.10	13.63	15.52	17.39	21.03	24.56	28.63	32.80	37.29	42.04	-	-	0.15	0.94	1.34	1.64
2400	8.50	9.72	11.13	12.53	14.12	16.08	18.00	21.76	25.39	29.55	33.80	38.34	43.08	-	-	0.15	0.98	1.39	1.71
2500	8.78	10.05	11.51	12.96	14.60	16.62	18.60	22.47	26.20	30.44	34.76	39.32	-	-	-	0.16	1.02	1.45	1.79
2600	9.06	10.37	11.88	13.38	15.07	17.15	19.19	23.17	26.97	31.30	35.66	40.23	-	-	-	0.16	1.06	1.51	1.86
2700	9.34	10.69	12.25	13.79	15.53	17.67	19.77	23.84	27.73	32.12	36.52	41.08	-	-	-	0.17	1.10	1.57	1.93
2800	9.61	11.00	12.60	14.19	15.98	18.17	20.33	24.49	28.45	32.90	37.32	-	-	-	-	0.18	1.15	1.63	2.00
2900	9.87	11.30	12.95	14.58	16.41	18.67	20.87	25.12	29.14	33.64	38.07	-	-	-	-	0.18	1.19	1.68	2.07
3000	10.13	11.60	13.29	14.96	16.84	19.15	21.40	25.73	29.81	34.34	38.77	-	-	-	-	0.19	1.23	1.74	2.14
3100	10.38	11.89	13.62	15.33	17.26	19.61	21.91	26.31	30.44	35.00	-	-	-	-	-	0.20	1.27	1.80	2.21
3200	10.62	12.17	13.95	15.70	17.66	20.07	22.41	26.88	31.05	35.62	-	-	-	-	-	0.20	1.31	1.86	2.28
3300	10.86	12.44	14.26	16.05	18.06	20.51	22.89	27.42	31.62	36.19	-	-	-	-	-	0.21	1.35	1.92	2.36
3400	11.09	12.71	14.57	16.39	18.44	20.93	23.35	27.93	32.16	36.71	-	-	-	-	-	0.22	1.39	1.97	2.43
3500	11.32	12.97	14.87	16.73	18.81	21.34	23.79	28.42	32.67	-	-	-	-	-	-	0.22	1.43	2.03	2.50
3600	11.54	13.22	15.16	17.05	19.17	21.74	24.22	28.89	33.14	-	-	-	-	-	-	0.23	1.47	2.09	2.57
3700	11.75	13.47	15.43	17.36	19.51	22.11	24.62	29.32	33.57	-	-	-	-	-	-	0.23	1.51	2.15	2.64
3800	11.95	13.70	15.70	17.66	19.84	22.48	25.01	29.73	33.97	-	-	-	-	-	-	0.24	1.55	2.21	2.71
3900	12.15	13.93	15.96	17.95	20.16	22.82	25.38	30.12	-	-	-	-	-	-	-	0.25	1.60	2.26	2.78
4000	12.34	14.15	16.21	18.23	20.46	23.15	25.73	30.47	-	-	-	-	-	-	-	0.25	1.64	2.32	2.86
4100	12.52	14.36	16.45	18.49	20.75	23.47	26.05	30.80	-	-	-	-	-	-	-	0.26	1.68	2.38	2.93
4200	12.70	14.56	16.68	18.75	21.03	23.76	26.36	31.10	-	-	-	-	-	-	-	0.27	1.72	2.44	3.00
4300	12.87	14.75	16.90	18.99	21.29	24.04	26.64	-	-	-	-	-	-	-	-	0.27	1.76	2.50	3.07
4400	13.03	14.94	17.11	19.22	21.54	24.30	26.91	-	-	-	-	-	-	-	-	0.28	1.80	2.55	3.14
4500	13.18	15.11	17.31	19.43	21.77	24.54	27.15	-	-	-	-	-	-	-	-	0.28	1.84	2.61	3.21
4600	13.32	15.28	17.49	19.63	21.98	24.76	27.36	-	-	-	-	-	-	-	-	0.29	1.88	2.67	3.28
4700	13.46	15.43	17.67	19.82	22.18	24.97	27.56	-	-	-	-	-	-	-	-	0.30	1.92	2.73	3.36
4800	13.58	15.58	17.83	20.00	22.37	25.15	-	-	-	-	-	-	-	-	-	0.30	1.96	2.79	3.43
4900	13.70	15.71	17.98	20.16	22.53	25.31	-	-	-	-	-	-	-	-	-	0.31	2.00	2.85	3.50
5000	13.81	15.84	18.12	20.31	22.68	25.46	-	-	-	-	-	-	-	-	-	0.32	2.05	2.90	3.57
5100	13.91	15.95	18.25	20.44	22.82	-	-	-	-	-	-	-	-	-	-	0.32	2.09	2.96	3.64
5200	14.00	16.06	18.36	20.56	22.93	-	-	-	-	-	-	-	-	-	-	0.33	2.13	3.02	3.71
5300	14.08	16.15	18.46	20.66	23.03	-	-	-	-	-	-	-	-	-	-	0.34	2.17	3.08	3.78
5400	14.15	16.23	18.55	20.75	23.11	-	-	-	-	-	-	-	-	-	-	0.34	2.21	3.14	3.86
5500	14.22	16.30	18.63	20.83	-	-	-	-	-	-	-	-	-	-	-	0.35	2.25	3.19	3.93
5600	14.27	16.36	18.69	20.88	-	-	-	-	-	-	-	-	-	-	-	0.35	2.29	3.25	4.00
5700	14.31	16.41	18.74	20.93	-	-	-	-	-	-	-	-	-	-	-	0.36	2.33	3.31	4.07
5800	14.35	16.45	18.77	-	-	-	-	-	-	-	-	-	-	-	-	0.37	2.37	3.37	4.14
5900	14.37	16.47	18.80	-	-	-	-	-	-	-	-	-	-	-	-	0.37	2.41	3.43	4.21
6000	14.38	16.49	18.80	-	-	-	-	-	-	-	-	-	-	-	-	0.38	2.45	3.48	4.28

Light blue box: Belt speed is over 30 m/sec. to 35 m/sec. Please consult our sales company or Engineering Department.
 Dark blue box: Belt speed is over 35 m/sec. to 40 m/sec. Please consult our sales company or Engineering Department.

2

Design

SPC-Section Power Rating

Table 2-36

[kw]

small pulley speed nd(rpm)	Basic power rating for small pulley datum diameter : Ps														Additional power rating for speed ratio (Pa)			
	Small pulley datum diameter dd (mm)														Speed ratio			
	224	250	280	300	315	335	355	375	400	450	500	560	630	710	1.01 to 1.05	1.06 to 1.26	1.27 to 1.57	<1.57
700	10.47	13.12	16.14	18.12	19.59	21.53	23.45	25.34	27.68	32.24	36.64	41.69	47.26	53.16	0.14	0.90	1.27	1.57
950	13.29	16.73	20.60	23.12	24.99	27.44	29.84	32.19	35.06	40.55	45.69	51.36	57.23	62.84	0.19	1.22	1.73	2.13
1450	17.83	22.52	27.67	30.95	33.32	36.37	39.27	42.03	45.25	50.91	55.44	-	-	-	0.29	1.86	2.64	3.25
2850	20.68	25.53	-	-	-	-	-	-	-	-	-	-	-	-	0.57	3.66	5.19	6.38
50	1.08	1.31	1.57	1.75	1.88	2.06	2.23	2.40	2.62	3.05	3.47	3.98	4.57	5.24	0.01	0.06	0.09	0.11
100	1.99	2.43	2.94	3.28	3.53	3.86	4.19	4.53	4.94	5.76	6.57	7.54	8.67	9.94	0.02	0.13	0.18	0.22
150	2.84	3.48	4.23	4.72	5.08	5.57	6.06	6.54	7.14	8.34	9.53	10.94	12.57	14.41	0.03	0.19	0.27	0.34
200	3.64	4.49	5.46	6.10	6.58	7.22	7.85	8.48	9.27	10.83	12.37	14.21	16.33	18.72	0.04	0.26	0.36	0.45
250	4.41	5.46	6.65	7.44	8.03	8.81	9.59	10.37	11.33	13.24	15.13	17.38	19.96	22.87	0.05	0.32	0.46	0.56
300	5.16	6.40	7.81	8.74	9.44	10.36	11.28	12.20	13.34	15.59	17.82	20.45	23.48	26.89	0.06	0.38	0.55	0.67
350	5.89	7.31	8.93	10.01	10.81	11.88	12.93	13.99	15.29	17.88	20.43	23.44	26.89	30.75	0.07	0.45	0.64	0.78
400	6.59	8.20	10.04	11.25	12.15	13.35	14.55	15.73	17.20	20.10	22.96	26.34	30.18	34.47	0.08	0.51	0.73	0.90
450	7.28	9.07	11.11	12.46	13.46	14.80	16.12	17.43	19.06	22.28	25.43	29.14	33.36	38.03	0.09	0.58	0.82	1.01
500	7.95	9.92	12.16	13.64	14.75	16.21	17.66	19.10	20.88	24.39	27.83	31.85	36.41	41.43	0.10	0.64	0.91	1.12
550	8.60	10.75	13.19	14.80	16.00	17.59	19.16	20.72	22.65	26.44	30.15	34.47	39.33	44.65	0.11	0.71	1.00	1.23
600	9.24	11.56	14.19	15.93	17.22	18.93	20.63	22.30	24.37	28.44	32.39	36.98	42.12	47.68	0.12	0.77	1.09	1.34
650	9.86	12.35	15.18	17.04	18.42	20.25	22.05	23.84	26.05	30.37	34.55	39.39	44.77	50.53	0.13	0.83	1.18	1.46
700	10.47	13.12	16.14	18.12	19.59	21.53	23.45	25.34	27.68	32.24	36.64	41.69	47.26	53.16	0.14	0.90	1.27	1.57
750	11.06	13.88	17.07	19.17	20.73	22.78	24.80	26.80	29.26	34.04	38.63	43.88	49.60	55.58	0.15	0.96	1.37	1.68
800	11.64	14.62	17.99	20.20	21.84	23.99	26.12	28.22	30.79	35.78	40.54	45.94	51.78	57.77	0.16	1.03	1.46	1.79
850	12.21	15.34	18.88	21.20	22.92	25.18	27.40	29.59	32.27	37.44	42.36	47.88	53.78	59.72	0.17	1.09	1.55	1.90
900	12.76	16.04	19.75	22.18	23.97	26.32	28.64	30.91	33.69	39.03	44.07	49.69	55.60	61.42	0.18	1.15	1.64	2.02
950	13.29	16.73	20.60	23.12	24.99	27.44	29.84	32.19	35.06	40.55	45.69	51.36	57.23	62.84	0.19	1.22	1.73	2.13
1000	13.81	17.39	21.42	24.04	25.98	28.51	30.99	33.42	36.37	41.99	47.21	52.89	58.66	63.99	0.20	1.28	1.82	2.24
1050	14.32	18.04	22.22	24.93	26.93	29.55	32.10	34.59	37.62	43.34	48.61	54.27	59.88	64.85	0.21	1.35	1.91	2.35
1100	14.81	18.67	22.99	25.80	27.86	30.55	33.17	35.72	38.81	44.62	49.90	55.50	60.89	-	0.22	1.41	2.00	2.46
1150	15.29	19.28	23.74	26.63	28.75	31.51	34.19	36.79	39.93	45.80	51.08	56.56	61.68	-	0.23	1.48	2.09	2.58
1200	15.75	19.87	24.46	27.43	29.60	32.43	35.16	37.81	40.99	46.90	52.13	57.46	62.23	-	0.24	1.54	2.19	2.69
1250	16.20	20.44	25.16	28.20	30.42	33.30	36.09	38.78	41.99	47.90	53.06	58.19	-	-	0.25	1.60	2.28	2.80
1300	16.63	20.99	25.83	28.94	31.20	34.14	36.96	39.68	42.91	48.80	53.86	58.74	-	-	0.26	1.67	2.37	2.91
1350	17.05	21.52	26.47	29.64	31.95	34.93	37.79	40.52	43.77	49.61	54.53	59.10	-	-	0.27	1.73	2.46	3.02
1400	17.45	22.03	27.09	30.31	32.66	35.67	38.56	41.31	44.54	50.31	55.06	-	-	-	0.28	1.80	2.55	3.13
1450	17.83	22.52	27.67	30.95	33.32	36.37	39.27	42.03	45.25	50.91	55.44	-	-	-	0.29	1.86	2.64	3.25
1500	18.20	22.98	28.23	31.55	33.95	37.02	39.93	42.68	45.87	51.40	55.68	-	-	-	0.30	1.92	2.73	3.36
1550	18.55	23.43	28.75	32.12	34.54	37.62	40.53	43.27	46.42	51.78	-	-	-	-	0.31	1.99	2.82	3.47
1600	18.89	23.85	29.25	32.65	35.08	38.17	41.08	43.79	46.88	52.04	-	-	-	-	0.32	2.05	2.91	3.58
1650	19.20	24.24	29.71	33.14	35.58	38.68	41.56	44.23	47.26	52.18	-	-	-	-	0.33	2.12	3.00	3.69
1700	19.50	24.62	30.14	33.59	36.04	39.12	41.98	44.61	47.55	-	-	-	-	-	0.34	2.18	3.10	3.81
1750	19.78	24.97	30.54	34.00	36.45	39.52	42.34	44.91	47.75	-	-	-	-	-	0.35	2.25	3.19	3.92
1800	20.04	25.29	30.91	34.37	36.82	39.86	42.63	45.14	47.87	-	-	-	-	-	0.36	2.31	3.28	4.03
1850	20.29	25.59	31.24	34.70	37.13	40.14	42.86	45.29	47.88	-	-	-	-	-	0.37	2.37	3.37	4.14
1900	20.51	25.87	31.54	34.99	37.40	40.36	43.02	45.36	47.81	-	-	-	-	-	0.38	2.44	3.46	4.25
1950	20.72	26.11	31.80	35.24	37.62	40.53	43.11	45.34	-	-	-	-	-	-	0.39	2.50	3.55	4.37
2000	20.90	26.34	32.02	35.44	37.79	40.63	43.13	45.25	-	-	-	-	-	-	0.40	2.57	3.64	4.48
2050	21.07	26.53	32.21	35.59	37.91	40.68	43.07	-	-	-	-	-	-	-	0.41	2.63	3.73	4.59
2100	21.21	26.70	32.36	35.70	37.97	40.66	42.94	-	-	-	-	-	-	-	0.42	2.69	3.82	4.70
2150	21.33	26.84	32.47	35.77	37.98	40.58	42.74	-	-	-	-	-	-	-	0.43	2.76	3.92	4.81
2200	21.44	26.95	32.54	35.78	37.94	40.43	-	-	-	-	-	-	-	-	0.44	2.82	4.01	4.93
2250	21.52	27.03	32.57	35.75	37.84	40.21	-	-	-	-	-	-	-	-	0.45	2.89	4.10	5.04
2300	21.58	27.08	32.56	35.67	37.68	-	-	-	-	-	-	-	-	-	0.46	2.95	4.19	5.15
2350	21.62	27.10	32.51	35.53	37.46	-	-	-	-	-	-	-	-	-	0.47	3.01	4.28	5.26
2400	21.63	27.09	32.42	35.34	37.19	-	-	-	-	-	-	-	-	-	0.48	3.08	4.37	5.37
2450	21.62	27.05	32.28	35.11	-	-	-	-	-	-	-	-	-	-	0.49	3.14	4.46	5.49
2500	21.59	26.98	32.10	34.81	-	-	-	-	-	-	-	-	-	-	0.50	3.21	4.55	5.60
2550	21.53	26.87	31.88	-	-	-	-	-	-	-	-	-	-	-	0.51	3.27	4.64	5.71
2600	21.45	26.73	31.61	-	-	-	-	-	-	-	-	-	-	-	0.52	3.34	4.73	5.82
2650	21.35	26.56	31.29	-	-	-	-	-	-	-	-	-	-	-	0.53	3.40	4.83	5.93
2700	21.22	26.36	30.93	-	-	-	-	-	-	-	-	-	-	-	0.54	3.46	4.92	6.05
2750	21.07	26.12	-	-	-	-	-	-	-	-	-	-	-	-	0.55	3.53	5.01	6.16
2800	20.88	25.84	-	-	-	-	-	-	-	-	-	-	-	-	0.56	3.59	5.10	6.27
2850	20.68	25.53	-	-	-	-	-	-	-	-	-	-	-	-	0.57	3.66	5.19	6.38
2900	20.45	25.18	-	-	-	-	-	-	-	-	-	-	-	-	0.58	3.72	5.28	6.49
2950	20.19	24.80	-	-	-	-	-	-	-	-	-	-	-	-	0.59	3.78	5.37	6.61
3000	19.90	24.38	-	-	-	-	-	-	-	-	-	-	-	-	0.60	3.85	5.46	6.72
3050	19.58	23.92	-	-	-	-	-	-	-	-	-	-	-	-	0.61	3.91	5.55	6.83
3100	19.24	-	-	-	-	-	-	-	-	-	-	-	-	-	0.62	3.98	5.64	6.94
3150	18.87	-	-	-	-	-	-	-	-	-	-	-	-	-	0.63	4.04	5.74	7.05
3200	18.47	-	-	-	-	-	-	-	-	-	-	-	-	-	0.63	4.11	5.83	7.17
3250	18.04	-	-	-	-	-	-	-	-	-	-	-	-	-	0.64	4.17	5.92	7.28
3300	17.58	-	-	-	-	-	-	-	-	-	-	-	-	-	0.65	4.23	6.01	7.39
3350	17.10	-	-	-	-	-	-	-	-	-	-	-	-	-	0.66	4.30	6.10	7.50
3400	16.58	-	-	-	-	-	-	-	-	-	-	-	-	-	0.67	4.36	6.19	7.61
3450	-	-	-	-	-	-	-	-	-	-	-	-	-	-	0.68	4.43	6.28	7.73
3500	-	-	-	-	-	-	-	-	-	-	-	-	-	-	0.69	4.49	6.37	7.84

SPCX-Section Power Rating

Table 2-37

[kw]

small pulley speed nd(rpm)	Basic power rating for small pulley datum diameter : Ps														Additional power rating for speed ratio (Pa)			
	Small pulley datum diameter dd (mm)														Speed ratio			
	180	200	224	250	280	315	335	355	400	450	500	560	630	710	1.01 to 1.05	1.06 to 1.26	1.27 to 1.57	1.57<
700	9.39	11.26	13.50	15.91	18.68	21.87	23.67	25.47	29.46	33.82	38.08	43.06	48.66	54.76	0.08	0.49	0.70	0.86
950	12.54	15.04	18.02	21.21	24.85	29.02	31.37	33.69	38.80	44.29	49.56	55.55	62.04	-	0.10	0.67	0.95	1.16
1450	18.51	22.17	26.47	31.03	36.13	41.86	45.01	48.07	54.59	61.17	66.97	-	-	-	0.16	1.02	1.44	1.77
2850	31.93	37.66	43.98	50.07	-	-	-	-	-	-	-	-	-	-	0.31	2.00	2.84	3.49
50	0.73	0.87	1.04	1.23	1.44	1.68	1.83	1.97	2.28	2.63	2.98	3.40	3.89	4.44	0.01	0.04	0.05	0.06
100	1.43	1.71	2.05	2.41	2.83	3.32	3.60	3.87	4.50	5.19	5.88	6.71	7.67	8.77	0.01	0.07	0.10	0.12
150	2.12	2.54	3.04	3.58	4.21	4.93	5.35	5.76	6.69	7.72	8.74	9.97	11.40	13.03	0.02	0.11	0.15	0.18
200	2.80	3.36	4.02	4.74	5.57	6.53	7.08	7.63	8.86	10.22	11.58	13.20	15.09	17.23	0.02	0.14	0.20	0.24
250	3.48	4.17	5.00	5.89	6.92	8.12	8.80	9.48	11.01	12.70	14.38	16.39	18.73	21.38	0.03	0.18	0.25	0.31
300	4.15	4.98	5.97	7.03	8.26	9.69	10.50	11.32	13.14	15.15	17.16	19.55	22.32	25.45	0.03	0.21	0.30	0.37
350	4.82	5.78	6.93	8.17	9.60	11.25	12.20	13.14	15.25	17.59	19.91	22.67	25.86	29.46	0.04	0.25	0.35	0.43
400	5.48	6.58	7.88	9.30	10.92	12.81	13.88	14.95	17.35	19.99	22.62	25.74	29.34	33.39	0.04	0.28	0.40	0.49
450	6.14	7.37	8.84	10.42	12.24	14.35	15.55	16.75	19.42	22.38	25.30	28.77	32.75	37.22	0.05	0.32	0.45	0.55
500	6.80	8.16	9.78	11.53	13.54	15.88	17.20	18.53	21.48	24.73	27.94	31.74	36.10	40.96	0.05	0.35	0.50	0.61
550	7.45	8.94	10.72	12.64	14.84	17.39	18.84	20.29	23.51	27.05	30.54	34.67	39.37	44.59	0.06	0.39	0.55	0.67
600	8.10	9.72	11.65	13.74	16.13	18.90	20.47	22.03	25.52	29.34	33.10	37.53	42.56	48.11	0.07	0.42	0.60	0.73
650	8.74	10.49	12.58	14.83	17.41	20.39	22.08	23.76	27.51	31.60	35.62	40.33	45.66	51.50	0.07	0.46	0.65	0.80
700	9.39	11.26	13.50	15.91	18.68	21.87	23.67	25.47	29.46	33.82	38.08	43.06	48.66	54.76	0.08	0.49	0.70	0.86
750	10.02	12.03	14.42	16.99	19.93	23.33	25.25	27.16	31.39	36.00	40.49	45.72	51.57	57.88	0.08	0.53	0.75	0.92
800	10.66	12.79	15.33	18.06	21.18	24.78	26.81	28.83	33.29	38.14	42.85	48.30	54.36	60.84	0.09	0.56	0.80	0.98
850	11.29	13.54	16.23	19.12	22.41	26.21	28.35	30.47	35.16	40.24	45.15	50.81	57.04	63.64	0.09	0.60	0.85	1.04
900	11.91	14.29	17.13	20.17	23.64	27.62	29.87	32.09	37.00	42.29	47.39	53.22	59.60	66.27	0.10	0.63	0.90	1.10
950	12.54	15.04	18.02	21.21	24.85	29.02	31.37	33.69	38.80	44.29	49.56	55.55	62.04	68.71	0.10	0.67	0.95	1.16
1000	13.15	15.78	18.90	22.24	26.04	30.40	32.85	35.26	40.57	46.24	51.66	57.78	64.33	70.97	0.11	0.70	0.99	1.22
1050	13.77	16.51	19.77	23.26	27.23	31.76	34.30	36.81	42.30	48.15	53.69	59.91	66.49	73.02	0.11	0.74	1.04	1.28
1100	14.38	17.24	20.64	24.27	28.39	33.10	35.73	38.32	43.99	49.99	55.65	61.94	68.50	-	0.12	0.77	1.09	1.35
1150	14.98	17.96	21.50	25.27	29.55	34.42	37.14	39.81	45.64	51.78	57.53	63.85	70.36	-	0.12	0.81	1.14	1.41
1200	15.58	18.68	22.35	26.26	30.69	35.72	38.52	41.27	47.25	53.51	59.33	65.66	72.05	-	0.13	0.84	1.19	1.47
1250	16.18	19.39	23.19	27.24	31.81	36.99	39.88	42.70	48.81	55.17	61.04	67.34	-	-	0.14	0.88	1.24	1.53
1300	16.77	20.09	24.03	28.21	32.92	38.25	41.20	44.09	50.33	56.77	62.66	68.91	-	-	0.14	0.91	1.29	1.59
1350	17.35	20.79	24.85	29.16	34.01	39.48	42.50	45.46	51.80	58.31	64.20	70.34	-	-	0.15	0.95	1.34	1.65
1400	17.94	21.48	25.67	30.10	35.08	40.68	43.77	46.78	53.22	59.77	65.63	-	-	-	0.15	0.98	1.39	1.71
1450	18.51	22.17	26.47	31.03	36.13	41.86	45.01	48.07	54.59	61.17	66.97	-	-	-	0.16	1.02	1.44	1.77
1500	19.08	22.84	27.27	31.94	37.17	43.01	46.22	49.33	55.90	62.48	68.21	-	-	-	0.16	1.05	1.49	1.84
1550	19.65	23.51	28.05	32.84	38.19	44.14	47.40	50.54	57.17	63.73	-	-	-	-	0.17	1.09	1.54	1.90
1600	20.21	24.17	28.83	33.73	39.18	45.24	48.54	51.72	58.37	64.89	-	-	-	-	0.17	1.12	1.59	1.96
1650	20.76	24.83	29.59	34.60	40.16	46.31	49.65	52.86	59.52	65.97	-	-	-	-	0.18	1.16	1.64	2.02
1700	21.31	25.47	30.35	35.46	41.11	47.35	50.73	53.95	60.61	-	-	-	-	-	0.18	1.19	1.69	2.08
1750	21.85	26.11	31.09	36.30	42.05	48.36	51.76	55.00	61.64	-	-	-	-	-	0.19	1.23	1.74	2.14
1800	22.38	26.74	31.82	37.12	42.96	49.34	52.76	56.01	62.61	-	-	-	-	-	0.20	1.26	1.79	2.20
1850	22.91	27.36	32.54	37.93	43.85	50.29	53.72	56.97	63.51	-	-	-	-	-	0.20	1.30	1.84	2.26
1900	23.43	27.97	33.25	38.73	44.72	51.20	54.65	57.88	64.34	-	-	-	-	-	0.21	1.33	1.89	2.32
1950	23.95	28.57	33.94	39.50	45.56	52.09	55.53	58.75	-	-	-	-	-	-	0.21	1.37	1.94	2.39
2000	24.46	29.17	34.62	40.26	46.38	52.93	56.37	59.57	-	-	-	-	-	-	0.22	1.40	1.99	2.45
2050	24.96	29.75	35.29	41.00	47.17	53.74	57.17	60.34	-	-	-	-	-	-	0.22	1.44	2.04	2.51
2100	25.46	30.33	35.95	41.72	47.94	54.52	57.93	61.05	-	-	-	-	-	-	0.23	1.47	2.09	2.57
2150	25.94	30.89	36.59	42.42	48.68	55.26	58.64	61.72	-	-	-	-	-	-	0.23	1.51	2.14	2.63
2200	26.42	31.45	37.22	43.11	49.39	55.96	59.30	-	-	-	-	-	-	-	0.24	1.54	2.19	2.69
2250	26.90	31.99	37.83	43.77	50.08	56.62	59.92	-	-	-	-	-	-	-	0.24	1.58	2.24	2.75
2300	27.36	32.53	38.43	44.42	50.74	57.24	-	-	-	-	-	-	-	-	0.25	1.61	2.29	2.81
2350	27.82	33.05	39.01	45.04	51.37	57.83	-	-	-	-	-	-	-	-	0.25	1.65	2.34	2.87
2400	28.27	33.57	39.58	45.64	51.98	58.37	-	-	-	-	-	-	-	-	0.26	1.68	2.39	2.94
2450	28.71	34.07	40.14	46.23	52.55	-	-	-	-	-	-	-	-	-	0.27	1.72	2.44	3.00
2500	29.14	34.56	40.68	46.79	53.09	-	-	-	-	-	-	-	-	-	0.27	1.75	2.49	3.06
2550	29.57	35.04	41.20	47.32	53.60	-	-	-	-	-	-	-	-	-	0.28	1.79	2.54	3.12
2600	29.98	35.51	41.71	47.84	54.08	-	-	-	-	-	-	-	-	-	0.28	1.82	2.59	3.18
2650	30.39	35.96	42.20	48.33	54.53	-	-	-	-	-	-	-	-	-	0.29	1.86	2.64	3.24
2700	30.79	36.41	42.67	48.80	54.95	-	-	-	-	-	-	-	-	-	0.29	1.89	2.69	3.30
2750	31.18	36.84	43.12	49.25	-	-	-	-	-	-	-	-	-	-	0.30	1.93	2.74	3.36
2800	31.56	37.26	43.56	49.67	-	-	-	-	-	-	-	-	-	-	0.30	1.96	2.79	3.43
2850	31.93	37.66	43.98	50.07	-	-	-	-	-	-	-	-	-	-	0.31	2.00	2.84	3.49
2900	32.29	38.06	44.39	50.44	-	-	-	-	-	-	-	-	-	-	0.31	2.03	2.89	3.55
2950	32.64	38.44	44.77	50.79	-	-	-	-	-	-	-	-	-	-	0.32	2.07	2.93	3.61
3000	32.98	38.80	45.14	51.11	-	-	-	-	-	-	-	-	-	-	0.33	2.10	2.98	3.67
3050	33.32	39.16	45.48	51.40	-	-	-	-	-	-	-	-	-	-	0.33	2.14	3.03	3.73
3100	33.64	39.50	45.81	-	-	-	-	-	-	-	-	-	-	-	0.34	2.17	3.08	3.79
3150	33.95	39.82	46.12	-	-	-	-	-	-	-	-	-	-	-	0.34	2.21	3.13	3.85
3200	34.25	40.13	46.41	-	-	-	-	-	-	-	-	-	-	-	0.35	2.24	3.18	3.91
3250	34.54	40.43	46.67	-	-	-	-	-	-	-	-	-	-	-	0.35	2.28	3.23	3.98
3300	34.82	40.71	46.92	-	-	-	-	-	-	-	-	-	-	-	0.36	2.31	3.28	4.04
3350	35.09	40.98	47.15	-	-	-	-	-	-	-	-	-	-	-	0.36	2.35	3.33	4.10
3400	35.35	41.23	47.35	-	-	-	-	-	-	-	-	-	-	-	0.37	2.38	3.38	4.16

3V-Section Power Rating

Table 2-38

[kw]

small pulley speed nd(rpm)	Basic power rating for small pulley effective diameter : Ps															Additional power rating for speed ratio (Pa)			
	Small pulley effective diameter de (mm)															Speed ratio			
	63	71	80	85	90	95	100	112	125	132	140	150	160	180	200	1.01 to 1.05	1.06 to 1.26	1.27 to 1.57	<1.57
700	0.52	0.71	0.92	1.04	1.15	1.27	1.39	1.66	1.96	2.12	2.30	2.52	2.74	3.18	3.62	0.01	0.07	0.09	0.12
950	0.65	0.91	1.19	1.35	1.50	1.65	1.81	2.17	2.56	2.77	3.01	3.30	3.59	4.17	4.74	0.01	0.09	0.13	0.16
1450	0.90	1.28	1.69	1.92	2.15	2.37	2.59	3.13	3.69	4.00	4.34	4.76	5.18	6.00	6.80	0.02	0.14	0.19	0.24
2850	1.45	2.12	2.87	3.28	3.68	4.08	4.47	5.40	6.36	6.86	7.43	8.11	8.76	9.99	11.11	0.04	0.27	0.38	0.47
100	0.10	0.13	0.17	0.19	0.21	0.23	0.25	0.29	0.34	0.37	0.39	0.43	0.47	0.54	0.61	0.00	0.01	0.01	0.02
200	0.19	0.24	0.31	0.35	0.38	0.42	0.46	0.54	0.64	0.69	0.74	0.81	0.88	1.02	1.16	0.00	0.02	0.03	0.03
300	0.26	0.35	0.44	0.50	0.55	0.60	0.66	0.78	0.92	0.99	1.07	1.18	1.28	1.48	1.68	0.00	0.03	0.04	0.05
400	0.33	0.44	0.57	0.64	0.71	0.78	0.85	1.01	1.19	1.28	1.39	1.53	1.66	1.92	2.19	0.01	0.04	0.05	0.07
500	0.39	0.53	0.69	0.78	0.86	0.95	1.03	1.23	1.45	1.57	1.70	1.86	2.03	2.35	2.67	0.01	0.05	0.07	0.08
600	0.46	0.62	0.81	0.91	1.01	1.11	1.21	1.45	1.71	1.84	2.00	2.20	2.39	2.77	3.15	0.01	0.06	0.08	0.10
700	0.52	0.71	0.92	1.04	1.15	1.27	1.39	1.66	1.96	2.12	2.30	2.52	2.74	3.18	3.62	0.01	0.07	0.09	0.12
800	0.57	0.79	1.03	1.16	1.29	1.43	1.56	1.87	2.20	2.38	2.59	2.84	3.09	3.58	4.07	0.01	0.08	0.11	0.13
900	0.63	0.87	1.14	1.28	1.43	1.58	1.72	2.07	2.44	2.64	2.87	3.15	3.43	3.98	4.52	0.01	0.08	0.12	0.15
1000	0.68	0.95	1.24	1.41	1.57	1.73	1.89	2.27	2.68	2.90	3.15	3.45	3.76	4.36	4.96	0.01	0.09	0.13	0.16
1100	0.73	1.02	1.35	1.52	1.70	1.88	2.05	2.47	2.91	3.15	3.42	3.75	4.09	4.74	5.38	0.02	0.10	0.15	0.18
1200	0.78	1.10	1.45	1.64	1.83	2.02	2.21	2.66	3.14	3.40	3.69	4.05	4.41	5.11	5.80	0.02	0.11	0.16	0.20
1300	0.83	1.17	1.55	1.75	1.96	2.16	2.37	2.85	3.36	3.64	3.95	4.34	4.72	5.47	6.21	0.02	0.12	0.17	0.21
1400	0.88	1.24	1.64	1.86	2.08	2.30	2.52	3.03	3.59	3.88	4.21	4.62	5.03	5.83	6.61	0.02	0.13	0.19	0.23
1500	0.93	1.31	1.74	1.97	2.21	2.44	2.67	3.22	3.80	4.11	4.47	4.90	5.33	6.17	7.00	0.02	0.14	0.20	0.25
1600	0.97	1.38	1.83	2.08	2.33	2.57	2.82	3.40	4.02	4.34	4.72	5.17	5.63	6.51	7.37	0.02	0.15	0.21	0.26
1700	1.02	1.45	1.92	2.19	2.45	2.71	2.96	3.57	4.22	4.57	4.96	5.44	5.92	6.84	7.74	0.02	0.16	0.23	0.28
1800	1.06	1.51	2.01	2.29	2.56	2.84	3.11	3.75	4.43	4.79	5.20	5.70	6.20	7.17	8.10	0.03	0.17	0.24	0.30
1900	1.10	1.58	2.10	2.39	2.68	2.97	3.25	3.92	4.63	5.01	5.44	5.96	6.48	7.48	8.44	0.03	0.18	0.25	0.31
2000	1.14	1.64	2.19	2.49	2.79	3.09	3.39	4.09	4.83	5.22	5.67	6.21	6.75	7.79	8.78	0.03	0.19	0.27	0.33
2100	1.18	1.70	2.28	2.59	2.91	3.22	3.52	4.25	5.03	5.43	5.89	6.46	7.01	8.08	9.10	0.03	0.20	0.28	0.35
2200	1.22	1.76	2.36	2.69	3.02	3.34	3.66	4.42	5.22	5.64	6.11	6.70	7.27	8.37	9.41	0.03	0.21	0.29	0.36
2300	1.26	1.82	2.44	2.78	3.12	3.46	3.79	4.57	5.40	5.84	6.33	6.93	7.52	8.65	9.71	0.03	0.22	0.31	0.38
2400	1.29	1.88	2.52	2.88	3.23	3.58	3.92	4.73	5.59	6.04	6.54	7.16	7.76	8.91	9.99	0.03	0.23	0.32	0.39
2500	1.33	1.93	2.60	2.97	3.33	3.69	4.05	4.88	5.77	6.23	6.75	7.38	8.00	9.17	10.27	0.04	0.24	0.33	0.41
2600	1.36	1.99	2.68	3.06	3.44	3.81	4.17	5.03	5.94	6.42	6.95	7.60	8.22	9.42	10.52	0.04	0.25	0.35	0.43
2700	1.40	2.04	2.76	3.15	3.54	3.92	4.29	5.18	6.11	6.60	7.14	7.81	8.45	9.66	10.77	0.04	0.25	0.36	0.44
2800	1.43	2.10	2.83	3.24	3.63	4.03	4.41	5.33	6.28	6.78	7.33	8.01	8.66	9.88	11.00	0.04	0.26	0.37	0.46
2900	1.46	2.15	2.91	3.32	3.73	4.13	4.53	5.47	6.44	6.95	7.52	8.20	8.86	10.10	11.21	0.04	0.27	0.39	0.48
3000	1.49	2.20	2.98	3.41	3.82	4.24	4.65	5.60	6.60	7.12	7.70	8.39	9.06	10.30	11.42	0.04	0.28	0.40	0.49
3100	1.52	2.25	3.05	3.49	3.92	4.34	4.76	5.74	6.75	7.28	7.87	8.57	9.25	10.49	11.60	0.05	0.29	0.41	0.51
3200	1.55	2.30	3.12	3.57	4.01	4.44	4.87	5.87	6.90	7.44	8.03	8.75	9.43	10.68	11.77	0.05	0.30	0.43	0.53
3300	1.58	2.35	3.19	3.65	4.10	4.54	4.98	6.00	7.05	7.59	8.19	8.91	9.60	10.84	11.92	0.05	0.31	0.44	0.54
3400	1.61	2.39	3.25	3.72	4.18	4.64	5.08	6.12	7.19	7.74	8.35	9.07	9.76	11.00	12.06	0.05	0.32	0.45	0.56
3500	1.64	2.44	3.32	3.80	4.27	4.73	5.18	6.24	7.32	7.88	8.50	9.22	9.91	11.14	12.17	0.05	0.33	0.47	0.58
3600	1.66	2.48	3.38	3.87	4.35	4.82	5.28	6.36	7.46	8.02	8.64	9.37	10.05	11.27	12.27	0.05	0.34	0.48	0.59
3700	1.69	2.52	3.44	3.94	4.43	4.91	5.38	6.47	7.58	8.15	8.77	9.50	10.19	11.39	12.36	0.05	0.35	0.49	0.61
3800	1.71	2.57	3.50	4.01	4.51	5.00	5.47	6.58	7.70	8.27	8.90	9.63	10.31	11.49	12.42	0.06	0.36	0.51	0.63
3900	1.73	2.61	3.56	4.08	4.58	5.08	5.57	6.68	7.82	8.39	9.02	9.75	10.42	11.58	-	0.06	0.37	0.52	0.64
4000	1.75	2.65	3.62	4.14	4.66	5.16	5.65	6.79	7.93	8.51	9.13	9.86	10.53	11.66	-	0.06	0.38	0.54	0.66
4100	1.77	2.68	3.67	4.21	4.73	5.24	5.74	6.88	8.03	8.61	9.24	9.96	10.62	11.72	-	0.06	0.39	0.55	0.67
4200	1.79	2.72	3.73	4.27	4.80	5.32	5.82	6.98	8.13	8.71	9.34	10.06	10.70	11.76	-	0.06	0.40	0.56	0.69
4300	1.81	2.76	3.78	4.33	4.87	5.39	5.90	7.07	8.23	8.81	9.43	10.14	10.77	-	-	0.06	0.41	0.58	0.71
4400	1.83	2.79	3.83	4.39	4.93	5.46	5.98	7.15	8.32	8.90	9.51	10.21	10.83	-	-	0.06	0.41	0.59	0.72
4500	1.85	2.82	3.88	4.44	4.99	5.53	6.05	7.23	8.40	8.98	9.59	10.28	10.88	-	-	0.07	0.42	0.60	0.74
4600	1.86	2.85	3.92	4.50	5.05	5.60	6.12	7.31	8.48	9.05	9.66	10.34	10.92	-	-	0.07	0.43	0.62	0.76
4700	1.88	2.88	3.97	4.55	5.11	5.66	6.19	7.38	8.55	9.12	9.72	10.38	10.94	-	-	0.07	0.44	0.63	0.77
4800	1.89	2.91	4.01	4.60	5.17	5.72	6.25	7.45	8.62	9.18	9.77	10.42	-	-	-	0.07	0.45	0.64	0.79
4900	1.91	2.94	4.05	4.64	5.22	5.78	6.31	7.52	8.68	9.24	9.82	10.44	-	-	-	0.07	0.46	0.66	0.81
5000	1.92	2.97	4.09	4.69	5.27	5.83	6.37	7.58	8.73	9.28	9.85	10.46	-	-	-	0.07	0.47	0.67	0.82
5100	1.93	2.99	4.13	4.73	5.32	5.88	6.42	7.63	8.78	9.32	9.88	-	-	-	-	0.07	0.48	0.68	0.84
5200	1.94	3.01	4.16	4.77	5.36	5.93	6.48	7.68	8.82	9.36	9.90	-	-	-	-	0.08	0.49	0.70	0.86
5300	1.95	3.04	4.20	4.81	5.41	5.98	6.52	7.73	8.86	9.38	9.90	-	-	-	-	0.08	0.50	0.71	0.87
5400	1.96	3.06	4.23	4.85	5.45	6.02	6.57	7.77	8.88	9.40	9.90	-	-	-	-	0.08	0.51	0.72	0.89
5500	1.97	3.08	4.26	4.88	5.48	6.06	6.61	7.81	8.91	9.41	-	-	-	-	-	0.08	0.52	0.74	0.90
5600	1.97	3.10	4.29	4.92	5.52	6.10	6.64	7.84	8.92	9.41	-	-	-	-	-	0.08	0.53	0.75	0.92
5800	1.98	3.13	4.34	4.97	5.58	6.16	6.71	7.88	8.93	-	-	-	-	-	-	0.08	0.55	0.78	0.95
6000	1.99	3.15	4.38	5.02	5.63	6.21	6.75	7.91	8.91	-	-	-	-	-	-	0.09	0.57	0.80	0.99
6200	1.99	3.17	4.41	5.06	5.67	6.25	6.79	7.92	-	-	-	-	-	-	-	0.09	0.58	0.83	1.02
6400	1.98	3.19	4.44	5.09	5.70	6.27	6.80	7.90	-	-	-	-	-	-	-	0.09	0.60	0.86	1.05
6600	1.97	3.19	4.46	5.11	5.71	6.28	6.80	7.86	-	-	-	-	-	-	-	0.10	0.62	0.88	1.09
6800	1.96	3.19	4.47	5.11	5.72	6.28	6.79	7.80	-	-	-	-	-	-	-	0.10	0.64	0.91	1.12
7																			

5V-Section Power Rating

Table 2-39

[kw]

small pulley speed nd(rpm)	Basic power rating for small pulley effective diameter : Ps															Additional power rating for speed ratio (Pa)			
	Small pulley effective diameter de (mm)															Speed ratio			
	140	150	160	180	190	200	212	224	236	250	280	315	355	375	400	1.01 to 1.05	1.06 to 1.26	1.27 to 1.57	1.57<
700	3.73	4.39	5.04	6.34	6.98	7.62	8.39	9.15	9.90	10.77	12.62	14.73	17.10	18.26	19.69	0.06	0.37	0.53	0.65
950	4.75	5.62	6.48	8.19	9.03	9.87	10.86	11.85	12.82	13.95	16.32	19.01	21.99	23.43	25.19	0.08	0.51	0.72	0.88
1450	6.55	7.80	9.03	11.46	12.65	13.83	15.22	16.58	17.92	19.46	22.63	26.11	29.78	31.49	33.48	0.12	0.77	1.10	1.35
2850	9.72	11.73	13.67	17.30	19.00	20.60	22.40	24.06	25.58	27.15	-	-	-	-	-	0.24	1.52	2.16	2.65
100	0.72	0.83	0.93	1.15	1.26	1.36	1.49	1.62	1.74	1.89	2.20	2.56	2.97	3.18	3.43	0.01	0.05	0.08	0.09
200	1.31	1.51	1.72	2.13	2.33	2.54	2.78	3.02	3.26	3.54	4.14	4.83	5.61	5.99	6.47	0.02	0.11	0.15	0.19
300	1.84	2.15	2.45	3.05	3.34	3.64	3.99	4.34	4.69	5.10	5.97	6.97	8.10	8.66	9.35	0.02	0.16	0.23	0.28
400	2.35	2.74	3.14	3.92	4.30	4.69	5.15	5.61	6.06	6.59	7.72	9.02	10.48	11.21	12.11	0.03	0.21	0.30	0.37
500	2.83	3.31	3.80	4.75	5.23	5.70	6.26	6.83	7.38	8.03	9.41	10.99	12.77	13.65	14.75	0.04	0.27	0.38	0.47
600	3.29	3.86	4.43	5.56	6.12	6.68	7.34	8.00	8.66	9.42	11.04	12.90	14.98	16.00	17.27	0.05	0.32	0.45	0.56
700	3.73	4.39	5.04	6.34	6.98	7.62	8.39	9.15	9.90	10.77	12.62	14.73	17.10	18.26	19.69	0.06	0.37	0.53	0.65
800	4.15	4.89	5.63	7.10	7.82	8.54	9.40	10.25	11.10	12.07	14.14	16.50	19.12	20.41	21.98	0.07	0.43	0.61	0.75
900	4.56	5.38	6.21	7.83	8.63	9.43	10.38	11.32	12.26	13.33	15.61	18.19	21.05	22.45	24.15	0.07	0.48	0.68	0.84
1000	4.95	5.86	6.76	8.54	9.42	10.29	11.33	12.36	13.38	14.55	17.02	19.81	22.89	24.38	26.19	0.08	0.53	0.76	0.93
1100	5.33	6.32	7.30	9.23	10.18	11.13	12.25	13.36	14.46	15.72	18.37	21.36	24.62	26.19	28.09	0.09	0.59	0.83	1.02
1200	5.69	6.76	7.81	9.89	10.92	11.93	13.14	14.33	15.50	16.85	19.67	22.82	26.24	27.87	29.83	0.10	0.64	0.91	1.12
1300	6.04	7.19	8.32	10.54	11.63	12.71	13.99	15.26	16.50	17.93	20.90	24.21	27.75	29.43	31.42	0.11	0.69	0.98	1.21
1400	6.38	7.60	8.80	11.16	12.32	13.46	14.82	16.15	17.46	18.96	22.07	25.50	29.14	30.84	32.84	0.12	0.75	1.06	1.30
1500	6.71	7.99	9.27	11.76	12.98	14.19	15.61	17.01	18.38	19.94	23.17	26.70	30.39	32.10	34.08	0.12	0.80	1.14	1.40
1600	7.02	8.38	9.71	12.33	13.61	14.88	16.36	17.82	19.25	20.87	24.20	27.80	31.52	33.20	35.13	0.13	0.85	1.21	1.49
1700	7.32	8.74	10.14	12.89	14.22	15.54	17.08	18.60	20.07	21.75	25.16	28.80	32.50	34.14	35.99	0.14	0.91	1.29	1.58
1800	7.60	9.09	10.56	13.41	14.80	16.17	17.77	19.33	20.85	22.56	26.03	29.70	33.33	34.90	36.63	0.15	0.96	1.36	1.68
1900	7.87	9.42	10.95	13.91	15.35	16.76	18.41	20.02	21.57	23.32	26.83	30.48	34.00	35.48	37.05	0.16	1.01	1.44	1.77
2000	8.13	9.74	11.32	14.39	15.88	17.33	19.02	20.66	22.24	24.02	27.55	31.15	34.52	35.87	-	0.17	1.07	1.51	1.86
2100	8.37	10.04	11.68	14.84	16.37	17.85	19.58	21.25	22.86	24.65	28.18	31.69	34.86	-	-	0.17	1.12	1.59	1.96
2200	8.60	10.33	12.01	15.27	16.83	18.35	20.11	21.80	23.42	25.22	28.71	32.11	-	-	-	0.18	1.17	1.67	2.05
2300	8.82	10.59	12.33	15.66	17.26	18.80	20.59	22.30	23.93	25.72	29.16	32.40	-	-	-	0.19	1.23	1.74	2.14
2400	9.01	10.84	12.62	16.03	17.65	19.22	21.03	22.74	24.37	26.15	29.51	32.56	-	-	-	0.20	1.28	1.82	2.24
2500	9.20	11.07	12.89	16.37	18.01	19.60	21.42	23.14	24.75	26.51	29.75	-	-	-	-	0.21	1.33	1.89	2.33
2600	9.37	11.28	13.14	16.67	18.34	19.94	21.76	23.47	25.07	26.79	29.89	-	-	-	-	0.21	1.39	1.97	2.42
2700	9.52	11.48	13.37	16.95	18.63	20.23	22.05	23.75	25.33	27.00	29.93	-	-	-	-	0.22	1.44	2.04	2.51
2800	9.66	11.65	13.57	17.19	18.88	20.49	22.30	23.97	25.51	27.12	-	-	-	-	-	0.23	1.49	2.12	2.61
2900	9.78	11.81	13.76	17.41	19.10	20.70	22.49	24.13	25.62	27.16	-	-	-	-	-	0.24	1.55	2.20	2.70
3000	9.88	11.94	13.91	17.59	19.28	20.87	22.63	24.23	25.67	27.11	-	-	-	-	-	0.25	1.60	2.27	2.79
3100	9.97	12.05	14.04	17.73	19.41	20.98	22.71	24.27	25.63	-	-	-	-	-	-	0.26	1.65	2.35	2.89
3200	10.03	12.14	14.15	17.84	19.51	21.06	22.74	24.24	25.52	-	-	-	-	-	-	0.26	1.71	2.42	2.98
3300	10.08	12.21	14.23	17.91	19.56	21.08	22.71	24.14	-	-	-	-	-	-	-	0.27	1.76	2.50	3.07
3400	10.12	12.26	14.29	17.95	19.57	21.05	22.63	23.97	-	-	-	-	-	-	-	0.28	1.81	2.57	3.17
3500	10.13	12.29	14.31	17.95	19.54	20.97	22.48	-	-	-	-	-	-	-	-	0.29	1.87	2.65	3.26
3600	10.12	12.29	14.31	17.90	19.46	20.84	22.26	-	-	-	-	-	-	-	-	0.30	1.92	2.73	3.35
3700	10.10	12.27	14.28	17.82	19.33	20.66	-	-	-	-	-	-	-	-	-	0.31	1.97	2.80	3.45
3800	10.05	12.22	14.22	17.70	19.16	20.42	-	-	-	-	-	-	-	-	-	0.31	2.03	2.88	3.54
3900	9.99	12.15	14.13	17.54	18.94	-	-	-	-	-	-	-	-	-	-	0.32	2.08	2.95	3.63
4000	9.90	12.05	14.02	17.33	18.66	-	-	-	-	-	-	-	-	-	-	0.33	2.13	3.03	3.73
4100	9.79	11.93	13.87	17.08	-	-	-	-	-	-	-	-	-	-	-	0.34	2.19	3.10	3.82
4200	9.66	11.78	13.69	16.79	-	-	-	-	-	-	-	-	-	-	-	0.35	2.24	3.18	3.91
4300	9.51	11.61	13.47	-	-	-	-	-	-	-	-	-	-	-	-	0.35	2.29	3.26	4.00
4400	9.34	11.41	13.23	-	-	-	-	-	-	-	-	-	-	-	-	0.36	2.35	3.33	4.10
4500	9.14	11.18	12.95	-	-	-	-	-	-	-	-	-	-	-	-	0.37	2.40	3.41	4.19
4600	8.92	10.92	12.63	-	-	-	-	-	-	-	-	-	-	-	-	0.38	2.45	3.48	4.28
4700	8.68	10.63	12.28	-	-	-	-	-	-	-	-	-	-	-	-	0.39	2.51	3.56	4.38
4800	8.41	10.31	-	-	-	-	-	-	-	-	-	-	-	-	-	0.40	2.56	3.64	4.47
4900	8.12	9.97	-	-	-	-	-	-	-	-	-	-	-	-	-	0.40	2.61	3.71	4.56
5000	7.80	9.59	-	-	-	-	-	-	-	-	-	-	-	-	-	0.41	2.67	3.79	4.66
5100	7.46	-	-	-	-	-	-	-	-	-	-	-	-	-	-	0.42	2.72	3.86	4.75
5200	7.09	-	-	-	-	-	-	-	-	-	-	-	-	-	-	0.43	2.77	3.94	4.84
5300	6.70	-	-	-	-	-	-	-	-	-	-	-	-	-	-	0.44	2.83	4.01	4.94
5400	6.28	-	-	-	-	-	-	-	-	-	-	-	-	-	-	0.45	2.88	4.09	5.03
5500	-	-	-	-	-	-	-	-	-	-	-	-	-	-	-	0.45	2.93	4.17	5.12

Light blue: Belt speed is over 30 m/sec. to 35 m/sec. Please consult our sales company or Engineering Department.
 Dark blue: Belt speed is over 35 m/sec. to 40 m/sec. Please consult our sales company or Engineering Department.

2

Design

8V-Section Power Rating

Table 2-40

[kw]

small pulley speed nd(rpm)	Basic power rating for small pulley effective diameter : Ps															Additional power rating for speed ratio (Pa)			
	Small pulley effective diameter de (mm)															Speed ratio			
	315	335	355	375	400	425	450	475	500	530	560	600	630	710	800	1.01 to 1.05	1.06 to 1.26	1.27 to 1.57	1.57<
450	18.09	20.34	22.58	24.80	27.55	30.28	32.98	35.66	38.32	41.48	44.60	48.71	51.74	59.66	68.24	0.19	1.22	1.73	2.13
700	25.93	29.22	32.47	35.69	39.65	43.55	47.38	51.15	54.86	59.21	63.47	68.97	72.98	83.08	93.40	0.29	1.90	2.70	3.31
950	32.62	36.79	40.87	44.87	49.76	54.52	59.15	63.63	67.96	72.95	77.72	83.70	87.89	97.75	106.35	0.40	2.58	3.66	4.50
1450	42.12	47.36	52.38	57.15	62.76	67.96	72.72	77.03	80.86	-	-	-	-	-	-	0.61	3.93	5.58	6.87
50	2.64	2.94	3.23	3.52	3.89	4.25	4.61	4.97	5.33	5.76	6.19	6.75	7.18	8.30	9.56	0.02	0.14	0.19	0.24
100	4.90	5.46	6.02	6.58	7.28	7.97	8.66	9.35	10.04	10.86	11.67	12.76	13.57	15.71	18.10	0.04	0.27	0.39	0.47
150	7.01	7.83	8.65	9.47	10.48	11.49	12.50	13.50	14.50	15.69	16.88	18.46	19.63	22.74	26.21	0.06	0.41	0.58	0.71
200	9.02	10.09	11.16	12.23	13.55	14.87	16.18	17.49	18.79	20.34	21.89	23.94	25.46	29.50	33.98	0.08	0.54	0.77	0.95
250	10.95	12.27	13.58	14.89	16.52	18.14	19.75	21.35	22.94	24.84	26.73	29.23	31.09	36.01	41.45	0.10	0.68	0.96	1.18
300	12.82	14.38	15.93	17.48	19.40	21.30	23.20	25.09	26.96	29.20	31.42	34.35	36.53	42.28	48.62	0.13	0.81	1.16	1.42
350	14.63	16.42	18.21	19.98	22.19	24.38	26.56	28.72	30.86	33.42	35.96	39.30	41.79	48.32	55.48	0.15	0.95	1.35	1.66
400	16.38	18.41	20.42	22.42	24.91	27.37	29.82	32.24	34.65	37.51	40.35	44.09	46.86	54.12	62.03	0.17	1.09	1.54	1.89
450	18.09	20.34	22.58	24.80	27.55	30.28	32.98	35.66	38.32	41.48	44.60	48.71	51.74	59.66	68.24	0.19	1.22	1.73	2.13
500	19.75	22.22	24.67	27.10	30.12	33.10	36.06	38.98	41.88	45.31	48.70	53.14	56.43	64.94	74.08	0.21	1.36	1.93	2.37
550	21.36	24.05	26.71	29.35	32.61	35.84	39.03	42.19	45.31	49.00	52.64	57.40	60.90	69.94	79.55	0.23	1.49	2.12	2.60
600	22.93	25.82	28.69	31.53	35.03	38.50	41.92	45.29	48.62	52.56	56.42	61.46	65.16	74.64	84.61	0.25	1.63	2.31	2.84
650	24.46	27.55	30.61	33.64	37.38	41.07	44.70	48.28	51.81	55.96	60.03	65.32	69.19	79.03	89.23	0.27	1.76	2.50	3.08
700	25.93	29.22	32.47	35.69	39.65	43.55	47.38	51.15	54.86	59.21	63.47	68.97	72.98	83.08	93.40	0.29	1.90	2.70	3.31
750	27.37	30.84	34.28	37.67	41.84	45.94	49.96	53.91	57.78	62.31	66.72	72.40	76.51	86.79	97.07	0.31	2.03	2.89	3.55
800	28.75	32.41	36.02	39.58	43.95	48.23	52.43	56.54	60.55	65.24	69.78	75.60	79.79	90.13	100.24	0.34	2.17	3.08	3.79
850	30.09	33.92	37.70	41.41	45.97	50.43	54.79	59.03	63.17	67.99	72.64	78.56	82.78	93.08	102.86	0.36	2.31	3.27	4.02
900	31.38	35.38	39.32	43.18	47.91	52.53	57.03	61.40	65.65	70.57	75.29	81.26	85.49	95.63	104.90	0.38	2.44	3.47	4.26
950	32.62	36.79	40.87	44.87	49.76	54.52	59.15	63.63	67.96	72.95	77.72	83.70	87.89	97.75	106.35	0.40	2.58	3.66	4.50
1000	33.82	38.13	42.35	46.49	51.52	56.41	61.14	65.71	70.10	75.15	79.93	85.86	89.98	99.42	-	0.42	2.71	3.85	4.74
1050	34.96	39.41	43.77	48.02	53.19	58.19	63.01	67.64	72.08	77.14	81.89	87.74	91.73	100.63	-	0.44	2.85	4.04	4.97
1100	36.05	40.64	45.11	49.48	54.76	59.85	64.74	69.41	73.87	78.92	83.61	89.31	93.14	-	-	0.46	2.98	4.24	5.21
1150	37.09	41.80	46.39	50.85	56.23	61.40	66.33	71.03	75.48	80.47	85.08	90.58	94.19	-	-	0.48	3.12	4.43	5.45
1200	38.07	42.90	47.59	52.13	57.60	62.82	67.78	72.48	76.90	81.81	86.28	91.52	94.87	-	-	0.50	3.26	4.62	5.68
1250	39.00	43.93	48.71	53.32	58.86	64.11	69.09	73.76	78.11	82.91	87.20	92.12	-	-	-	0.52	3.39	4.81	5.92
1300	39.87	44.89	49.75	54.42	60.01	65.28	70.24	74.86	79.12	83.76	87.84	-	-	-	-	0.55	3.53	5.01	6.16
1350	40.68	45.79	50.71	55.43	61.04	66.31	71.23	75.77	79.92	84.37	88.19	-	-	-	-	0.57	3.66	5.20	6.39
1400	41.43	46.61	51.59	56.34	61.96	67.21	72.06	76.50	80.50	84.71	-	-	-	-	-	0.59	3.80	5.39	6.63
1450	42.12	47.36	52.38	57.15	62.76	67.96	72.72	77.03	80.86	-	-	-	-	-	-	0.61	3.93	5.58	6.87
1500	42.74	48.04	53.08	57.86	63.44	68.57	73.22	77.36	80.98	-	-	-	-	-	-	0.63	4.07	5.78	7.10
1550	43.30	48.64	53.70	58.46	63.99	69.03	73.53	77.48	-	-	-	-	-	-	-	0.65	4.20	5.97	7.34
1600	43.80	49.16	54.22	58.96	64.42	69.33	73.66	77.39	-	-	-	-	-	-	-	0.67	4.34	6.16	7.58
1650	44.23	49.60	54.64	59.34	64.71	69.47	73.61	-	-	-	-	-	-	-	-	0.69	4.48	6.35	7.81
1700	44.58	49.96	54.97	59.61	64.86	69.45	-	-	-	-	-	-	-	-	-	0.71	4.61	6.55	8.05
1750	44.87	50.23	55.20	59.77	64.87	69.26	-	-	-	-	-	-	-	-	-	0.73	4.75	6.74	8.29
1800	45.08	50.42	55.33	59.80	64.74	-	-	-	-	-	-	-	-	-	-	0.76	4.88	6.93	8.52
1850	45.22	50.52	55.35	59.71	64.46	-	-	-	-	-	-	-	-	-	-	0.78	5.02	7.12	8.76
1900	45.29	50.52	55.27	59.50	64.03	-	-	-	-	-	-	-	-	-	-	0.80	5.15	7.32	9.00
1950	45.28	50.44	55.08	59.16	-	-	-	-	-	-	-	-	-	-	-	0.82	5.29	7.51	9.23
2000	45.18	50.26	54.77	58.69	-	-	-	-	-	-	-	-	-	-	-	0.84	5.43	7.70	9.47
2050	45.01	49.99	54.35	-	-	-	-	-	-	-	-	-	-	-	-	0.86	5.56	7.89	9.71
2100	44.75	49.61	53.82	-	-	-	-	-	-	-	-	-	-	-	-	0.88	5.70	8.09	9.94
2150	44.41	49.14	53.16	-	-	-	-	-	-	-	-	-	-	-	-	0.90	5.83	8.28	10.18
2200	43.99	48.56	-	-	-	-	-	-	-	-	-	-	-	-	-	0.92	5.97	8.47	10.42
2250	43.48	47.88	-	-	-	-	-	-	-	-	-	-	-	-	-	0.94	6.10	8.66	10.65

Light blue: Belt speed is over 30 m/sec. to 35 m/sec. Please consult our sales company or Engineering Department.
 Dark blue: Belt speed is over 35 m/sec. to 40 m/sec. Please consult our sales company or Engineering Department.

2

Design



Maxstar Wedge V-Belts

● 3V-3VX (SR = 1.00 ~ 1.41)

Table 2-41-1 Drive Selection Table

Speed ratio	Effective diameter (mm)		Center distance (mm)													
	Small pulley	Large pulley	3V	3V	3V	3V	3V	3V	3V	3V	3V	3V	3V	3V	3V	
			250	265	280	300	315	335	355	375	400	425	450	475	500	530
1.00	67	67	212	231	250	276	295	320	346	371	403	435	466	498	530	568
1.00	71	71	206	225	244	269	288	314	339	365	396	428	460	492	523	561
1.00	75	75	200	219	238	263	282	308	333	359	390	422	454	486	517	555
1.00	80	80	192	211	230	255	274	300	325	351	382	414	446	478	509	547
1.00	85	85	184	203	222	247	266	292	317	343	374	406	438	470	501	539
1.00	90	90	176	195	214	240	259	284	310	335	367	399	430	462	494	532
1.00	95	95	168	187	206	232	251	276	302	327	359	391	422	454	486	524
1.00	100	100	160	179	198	224	243	268	294	319	351	383	414	446	478	516
1.00	112	112	142	161	180	205	224	250	275	301	332	364	396	428	459	497
1.00	125	125	-	140	159	185	204	229	255	280	312	344	375	407	439	477
1.00	140	140	-	-	-	161	180	206	231	257	288	320	352	384	415	453
1.00	150	150	-	-	-	-	164	190	215	241	272	304	336	368	399	437
1.00	160	160	-	-	-	-	-	174	200	225	257	289	320	352	384	422
1.00	180	180	-	-	-	-	-	-	-	194	225	257	289	321	352	390
1.00	200	200	-	-	-	-	-	-	-	-	-	226	257	289	321	359
1.00	250	250	-	-	-	-	-	-	-	-	-	-	-	-	-	280
1.00	315	315	-	-	-	-	-	-	-	-	-	-	-	-	-	-
1.05	95	100	164	183	202	228	247	272	298	323	355	387	418	450	482	520
1.06	67	71	209	228	247	273	292	317	343	368	400	432	463	495	527	565
1.06	71	75	203	222	241	266	285	311	336	362	393	425	457	489	520	558
1.06	80	85	188	207	226	251	270	296	321	347	378	410	442	474	505	543
1.06	85	90	180	199	218	244	263	288	314	339	371	403	434	466	498	536
1.06	90	95	172	191	210	236	255	280	306	331	363	395	426	458	490	528
1.07	75	80	196	215	234	259	278	304	329	355	386	418	450	482	513	551
1.07	140	150	-	-	-	-	172	198	223	249	280	312	344	376	407	445
1.07	150	160	-	-	-	-	-	182	207	233	264	296	328	360	391	429
1.11	90	100	168	187	206	232	251	276	302	327	359	391	422	454	486	524
1.11	180	200	-	-	-	-	-	-	-	-	209	241	273	305	336	374
1.12	67	75	206	225	244	269	288	314	339	365	396	428	460	492	523	561
1.12	85	95	176	195	214	240	259	284	310	335	367	399	430	462	494	532
1.12	100	112	151	170	189	214	233	259	284	310	341	373	405	437	468	506
1.12	112	125	131	150	169	195	214	239	265	290	322	354	385	417	449	487
1.12	125	140	-	-	147	173	192	217	243	268	300	332	363	395	427	465
1.13	71	80	199	218	237	262	281	307	332	358	389	421	453	485	516	554
1.13	80	90	184	203	222	247	266	292	317	343	374	406	438	470	501	539
1.13	160	180	-	-	-	-	-	-	184	209	241	273	304	336	368	406
1.14	75	85	192	211	230	255	274	300	325	351	382	414	446	478	509	547
1.14	140	160	-	-	-	-	164	190	215	241	272	304	336	368	399	437
1.18	85	100	172	191	210	236	255	280	306	331	363	395	426	458	490	528
1.18	95	112	155	174	193	218	237	263	288	314	345	377	409	441	472	510
1.19	80	95	180	199	218	243	262	288	313	339	370	402	434	466	497	536
1.20	67	80	202	221	240	265	284	310	335	361	392	424	456	488	520	558
1.20	71	85	195	214	233	258	277	303	328	354	385	417	449	481	512	550
1.20	75	90	188	207	226	251	270	296	321	347	378	410	442	474	505	543
1.20	125	150	-	-	-	165	184	209	235	260	292	324	355	387	419	457
1.20	150	180	-	-	-	-	-	-	191	217	248	280	312	344	376	414
1.25	80	100	176	195	214	239	258	284	309	335	366	399	430	462	494	532
1.25	90	112	158	178	197	222	241	267	292	318	349	381	413	445	476	514
1.25	100	125	140	159	178	204	223	248	274	300	331	363	395	427	458	496
1.25	112	140	-	138	157	183	202	227	253	278	310	342	373	405	437	475
1.25	160	200	-	-	-	-	-	-	-	193	224	256	288	320	352	390
1.25	200	250	-	-	-	-	-	-	-	-	-	-	-	249	280	319
1.26	250	315	-	-	-	-	-	-	-	-	-	-	-	-	-	-
1.27	67	85	198	217	236	261	280	306	331	357	389	421	452	484	516	554
1.27	71	90	191	210	229	254	273	299	324	350	381	413	445	477	508	546
1.27	75	95	184	203	222	247	266	292	317	343	374	406	438	470	501	539
1.27	315	400	-	-	-	-	-	-	-	-	-	-	-	-	-	-
1.28	125	160	-	-	-	156	175	201	226	252	284	316	347	379	411	449
1.29	140	180	-	-	-	-	-	173	199	224	256	288	320	352	383	421
1.32	85	112	162	181	200	226	245	270	296	321	353	385	417	449	480	518
1.32	95	125	144	163	182	208	227	252	278	303	335	367	398	430	462	500
1.34	71	95	187	206	225	250	269	295	320	346	377	409	441	473	504	542
1.34	75	100	180	199	218	243	262	288	313	339	370	402	434	466	497	535
1.34	112	150	-	-	149	174	193	219	244	270	302	334	365	397	429	467
1.34	150	200	-	-	-	-	-	-	-	200	232	264	296	328	359	397
1.35	67	90	194	213	232	257	276	302	327	353	385	417	448	480	512	550
1.39	90	125	148	167	186	211	230	256	282	307	339	371	402	434	466	504
1.39	180	250	-	-	-	-	-	-	-	-	-	-	231	263	295	333
1.40	100	140	-	147	166	191	211	236	262	287	319	351	382	415	446	484
1.41	80	112	166	185	204	230	249	274	300	325	357	389	420	452	484	522

2

Design

3V·3VX
1.00 ~ 1.41

Color coding of Power rating correction factor : Kc

0.7	0.8	0.9	1.0	1.1	1.2
-----	-----	-----	-----	-----	-----

Center distance (mm)																	Speed ratio
3V 560	3V 600	3V 630	3V 670	3V 710	3V 750	3V 800	3V 850	3V 900	3V 950	3V 1000	3V 1060	3V 1120	3V 1180	3V 1250	3V 1320	3V 1400	
606	657	695	746	796	847	911	974	1038	1101	1165	1241	1317	1393	1482	1571	1673	1.00
599	650	688	739	790	841	904	968	1031	1095	1158	1234	1311	1387	1476	1565	1666	1.00
593	644	682	733	784	835	898	962	1025	1089	1152	1228	1305	1381	1470	1559	1660	1.00
585	636	674	725	776	827	890	954	1017	1081	1144	1220	1297	1373	1462	1551	1652	1.00
577	628	666	717	768	819	882	946	1009	1073	1136	1212	1289	1365	1454	1543	1644	1.00
570	621	659	710	760	811	875	938	1002	1065	1129	1205	1281	1357	1446	1535	1637	1.00
562	613	651	702	752	803	867	930	994	1057	1121	1197	1273	1349	1438	1527	1629	1.00
554	605	643	694	744	795	859	922	986	1049	1113	1189	1265	1341	1430	1519	1621	1.00
535	586	624	675	726	777	840	904	967	1031	1094	1170	1247	1323	1412	1501	1602	1.00
515	566	604	655	705	756	820	883	947	1010	1074	1150	1226	1302	1391	1480	1582	1.00
491	542	580	631	682	733	796	860	923	987	1050	1126	1203	1279	1368	1457	1558	1.00
475	526	564	615	666	717	780	844	907	971	1034	1110	1187	1263	1352	1441	1542	1.00
460	511	549	600	650	701	765	828	892	955	1019	1095	1171	1247	1336	1425	1527	1.00
428	479	517	568	619	670	733	797	860	924	987	1063	1140	1216	1305	1394	1495	1.00
397	448	486	537	587	638	702	765	829	892	956	1032	1108	1184	1273	1362	1464	1.00
318	369	407	458	509	560	623	687	750	814	877	953	1030	1106	1195	1284	1385	1.00
-	-	-	356	407	458	521	585	648	712	775	851	928	1004	1093	1182	1283	1.00
558	609	647	698	748	799	863	926	990	1053	1117	1193	1269	1345	1434	1523	1625	1.05
603	654	692	743	793	844	908	971	1035	1098	1162	1238	1314	1390	1479	1568	1670	1.06
596	647	685	736	787	838	901	965	1028	1092	1155	1231	1308	1384	1473	1562	1663	1.06
581	632	670	721	772	823	886	950	1013	1077	1140	1216	1293	1369	1458	1547	1648	1.06
574	625	663	714	764	815	879	942	1006	1069	1133	1209	1285	1361	1450	1539	1641	1.06
566	617	655	706	756	807	871	934	998	1061	1125	1201	1277	1353	1442	1531	1633	1.06
589	640	678	729	780	831	894	958	1021	1085	1148	1224	1301	1377	1466	1555	1656	1.07
483	534	572	623	674	725	788	852	915	979	1042	1118	1195	1271	1360	1449	1550	1.07
467	519	557	608	658	709	773	836	900	963	1027	1103	1179	1255	1344	1433	1535	1.07
562	613	651	702	752	803	867	930	994	1057	1121	1197	1273	1349	1438	1527	1629	1.11
412	463	501	552	603	654	717	781	844	908	971	1048	1124	1200	1289	1378	1480	1.11
599	650	688	739	790	841	904	968	1031	1095	1158	1234	1311	1387	1476	1565	1666	1.12
570	621	659	710	760	811	875	938	1002	1065	1129	1205	1281	1357	1446	1535	1637	1.12
544	595	633	684	735	786	849	913	976	1040	1103	1179	1256	1332	1421	1510	1611	1.12
525	576	614	665	715	766	830	893	957	1020	1084	1160	1236	1312	1401	1490	1592	1.12
503	554	592	643	693	744	808	871	935	998	1062	1138	1214	1290	1379	1468	1570	1.12
592	643	681	732	783	834	897	961	1024	1088	1151	1227	1304	1380	1469	1558	1659	1.13
577	628	666	717	768	819	882	946	1009	1073	1136	1212	1289	1365	1454	1543	1644	1.13
444	495	533	584	634	685	749	812	876	939	1003	1079	1155	1231	1320	1409	1511	1.13
585	636	674	725	776	827	890	954	1017	1081	1144	1220	1297	1373	1462	1551	1652	1.14
475	526	564	615	666	717	780	844	907	971	1034	1110	1187	1263	1352	1441	1542	1.14
566	617	655	706	756	807	871	934	998	1061	1125	1201	1277	1353	1442	1531	1633	1.18
548	599	637	688	739	790	853	917	980	1044	1107	1183	1260	1336	1425	1514	1615	1.18
574	625	663	714	764	815	879	942	1006	1069	1133	1209	1285	1361	1450	1539	1641	1.19
596	647	685	736	786	837	901	964	1028	1091	1155	1231	1307	1383	1472	1561	1663	1.20
588	639	677	728	779	830	893	957	1020	1084	1147	1223	1300	1376	1465	1554	1655	1.20
581	632	670	721	772	823	886	950	1013	1077	1140	1216	1293	1369	1458	1547	1648	1.20
495	546	584	635	685	736	800	863	927	990	1054	1130	1206	1282	1371	1460	1562	1.20
452	503	541	592	642	693	757	820	884	947	1011	1087	1163	1239	1328	1417	1519	1.20
570	621	659	710	760	811	875	938	1002	1065	1129	1205	1281	1357	1446	1535	1637	1.25
552	603	641	692	743	794	857	921	984	1048	1111	1187	1264	1340	1429	1518	1619	1.25
534	585	623	674	725	776	839	903	966	1030	1093	1169	1246	1322	1411	1500	1601	1.25
513	564	602	653	703	754	818	881	945	1008	1072	1148	1224	1301	1390	1479	1580	1.25
428	479	517	568	618	669	733	797	860	924	987	1063	1140	1216	1305	1394	1495	1.25
357	408	446	497	548	599	662	726	789	853	916	992	1069	1145	1234	1323	1424	1.25
-	317	355	406	457	508	571	635	698	762	826	902	978	1054	1143	1232	1334	1.26
592	643	681	732	782	833	897	960	1024	1087	1151	1227	1303	1379	1468	1557	1659	1.27
584	635	673	724	775	826	890	953	1017	1080	1144	1220	1296	1372	1461	1550	1652	1.27
577	628	666	717	768	819	882	946	1009	1073	1136	1212	1289	1365	1454	1543	1644	1.27
-	-	-	-	-	389	452	516	580	644	707	783	860	936	1025	1114	1216	1.27
487	538	576	627	677	728	792	855	919	983	1046	1122	1199	1275	1364	1453	1554	1.28
459	510	548	599	650	701	764	828	891	955	1018	1094	1171	1247	1336	1425	1527	1.29
556	607	645	696	747	798	861	925	988	1052	1115	1191	1268	1344	1433	1522	1623	1.32
538	589	627	678	729	780	843	907	970	1034	1097	1173	1250	1326	1415	1504	1605	1.32
580	632	670	721	771	822	886	949	1013	1076	1140	1216	1292	1368	1457	1546	1648	1.34
573	624	662	713	764	815	878	942	1005	1069	1132	1208	1285	1361	1450	1539	1641	1.34
505	556	594	645	695	746	810	874	937	1001	1064	1140	1217	1293	1382	1471	1572	1.34
435	486	525	576	626	677	741	804	868	931	995	1071	1147	1223	1312	1401	1503	1.34
588	639	677	728	778	829	893	956	1020	1083	1147	1223	1299	1375	1464	1553	1655	1.35
542	593	631	682	732	783	847	910	974	1037	1101	1177	1254	1330	1419	1508	1609	1.39
372	423	461	512	563	614	677	741	805	868	932	1008	1084	1160	1249	1338	1440	1.39
522	573	611	662	713	764	827	891	954	1018	1081	1157	1234	1310	1399	1488	1589	1.40
560	611	649	700	751	802	865	929	992	1056	1119	1195	1272	1348	1437	1526	1627	1.41

2
Design



● 3V·3VX (SR = 1.42 ~ 2.52)

Table 2-41-2 Drive Selection Table

Speed ratio	Effective diameter (mm)		Center distance (mm)													
	Small pulley	Large pulley	3V	3V	3V	3V	3V	3V	3V	3V	3V	3V	3V	3V	3V	3V
			250	265	280	300	315	335	355	375	400	425	450	475	500	530
1.42	71	100	183	202	221	246	265	291	316	342	373	405	437	469	500	539
1.43	67	95	190	209	228	253	272	298	323	349	381	413	444	476	508	546
1.43	112	160	-	-	-	166	185	211	236	262	293	325	357	389	421	459
1.43	140	200	-	-	-	-	-	-	181	207	239	271	303	335	367	405
1.44	125	180	-	-	-	-	-	184	210	235	267	299	331	363	394	433
1.48	85	125	151	170	190	215	234	260	285	311	342	375	406	438	470	508
1.48	95	140	131	150	169	195	214	240	265	291	323	355	386	418	450	488
1.5	67	100	186	205	224	249	268	294	319	345	376	409	440	472	504	542
1.5	75	112	170	189	208	233	252	278	304	329	361	393	424	456	488	526
1.51	100	150	-	138	157	183	202	228	253	279	311	343	374	406	438	476
1.56	90	140	135	154	173	199	218	244	269	295	326	358	390	422	454	492
1.57	80	125	155	174	193	219	238	264	289	315	346	378	410	442	473	511
1.57	160	250	-	-	-	-	-	-	-	-	-	-	245	278	310	348
1.58	200	315	-	-	-	-	-	-	-	-	-	-	-	-	-	-
1.59	71	112	173	192	211	236	255	281	307	332	364	396	427	459	491	529
1.59	95	150	-	141	161	187	206	231	257	283	314	346	378	410	442	480
1.59	315	500	-	-	-	-	-	-	-	-	-	-	-	-	-	-
1.6	250	400	-	-	-	-	-	-	-	-	-	-	-	-	-	-
1.61	100	160	-	-	148	174	193	219	245	271	302	334	366	398	430	468
1.61	112	180	-	-	-	-	167	193	219	245	277	309	340	373	404	442
1.61	125	200	-	-	-	-	-	-	192	218	250	282	314	346	378	416
1.66	85	140	138	157	177	202	222	247	273	299	330	362	394	426	457	496
1.67	150	250	-	-	-	-	-	-	-	-	-	220	252	285	317	355
1.68	67	112	175	195	214	239	258	284	310	335	367	399	430	462	494	532
1.68	75	125	158	178	197	223	242	267	293	318	350	382	414	446	477	515
1.68	90	150	-	145	164	190	209	235	261	286	318	350	382	414	445	484
1.69	95	160	-	-	152	178	197	223	249	274	306	338	370	402	434	472
1.76	80	140	142	161	180	206	225	251	277	302	334	366	398	430	461	499
1.76	180	315	-	-	-	-	-	-	-	-	-	-	-	-	-	276
1.77	71	125	161	181	200	225	245	270	296	321	353	385	417	449	480	518
1.78	85	150	129	148	168	194	213	239	264	290	322	354	386	418	449	487
1.79	90	160	-	136	155	181	201	226	252	278	310	342	374	406	437	475
1.79	112	200	-	-	-	-	-	175	201	227	259	292	323	356	387	426
1.79	140	250	-	-	-	-	-	-	-	-	-	227	259	292	324	363
1.81	100	180	-	-	-	156	176	202	228	253	285	318	349	381	413	451
1.88	67	125	164	183	203	228	248	273	299	324	356	388	420	452	483	521
1.88	75	140	145	164	184	210	229	255	280	306	338	370	401	433	465	503
1.89	80	150	132	152	171	197	217	242	268	294	325	358	389	421	453	491
1.89	85	160	-	139	159	185	204	230	256	282	313	346	377	409	441	479
1.91	95	180	-	-	-	159	179	205	231	257	289	321	353	385	417	455
1.98	160	315	-	-	-	-	-	-	-	-	-	-	-	-	250	290
1.99	71	140	148	167	187	212	232	257	283	309	341	373	404	436	468	506
2	250	500	-	-	-	-	-	-	-	-	-	-	-	-	-	-
2	315	630	-	-	-	-	-	-	-	-	-	-	-	-	-	-
2.01	90	180	-	-	-	163	182	209	235	261	292	325	357	389	421	459
2.01	100	200	-	-	-	-	-	183	209	236	268	300	332	364	396	435
2.01	125	250	-	-	-	-	-	-	-	-	204	237	270	303	335	373
2.01	200	400	-	-	-	-	-	-	-	-	-	-	-	-	-	-
2.02	75	150	136	155	175	201	220	246	272	297	329	361	393	425	457	495
2.02	80	160	-	142	162	188	208	234	259	285	317	349	381	413	445	483
2.11	67	140	150	170	189	215	235	260	286	312	343	376	407	439	471	509
2.11	150	315	-	-	-	-	-	-	-	-	-	-	-	-	257	296
2.12	95	200	-	-	-	-	160	186	213	239	271	304	336	368	400	438
2.13	71	150	138	158	178	204	223	249	275	300	332	364	396	428	460	498
2.13	85	180	-	-	-	166	186	212	238	264	296	328	360	392	424	462
2.15	75	160	-	146	165	192	211	237	263	289	321	353	385	417	448	487
2.23	180	400	-	-	-	-	-	-	-	-	-	-	-	-	-	-
2.24	90	200	-	-	-	-	163	190	216	242	275	307	339	372	403	442
2.25	112	250	-	-	-	-	-	-	-	-	212	246	279	312	344	382
2.26	67	150	141	161	180	206	226	252	277	303	335	367	399	431	463	501
2.26	140	315	-	-	-	-	-	-	-	-	-	-	-	-	263	303
2.27	80	180	-	-	143	169	189	215	242	268	300	332	364	396	428	466
2.28	71	160	128	148	168	194	214	240	266	292	324	356	388	420	451	490
2.37	85	200	-	-	-	-	166	193	220	246	278	311	343	375	407	445
2.41	67	160	131	151	171	197	217	243	269	295	326	359	390	423	454	493
2.42	75	180	-	-	146	173	193	219	245	271	303	336	367	400	432	470
2.51	160	400	-	-	-	-	-	-	-	-	-	-	-	-	-	-
2.51	200	500	-	-	-	-	-	-	-	-	-	-	-	-	-	-
2.52	80	200	-	-	-	-	169	196	223	249	282	314	346	379	411	449
2.52	100	250	-	-	-	-	-	-	-	187	220	254	287	320	352	391

2
Design

3V-3VX
1.42 ~ 2.52

Color coding of Power rating correction factor : Kc

0.7	0.8	0.9	1.0	1.1	1.2
-----	-----	-----	-----	-----	-----

Center distance (mm)																	Speed ratio
3V 560	3V 600	3V 630	3V 670	3V 710	3V 750	3V 800	3V 850	3V 900	3V 950	3V 1000	3V 1060	3V 1120	3V 1180	3V 1250	3V 1320	3V 1400	
577	628	666	717	767	818	882	945	1009	1072	1136	1212	1288	1364	1453	1542	1644	1.42
584	635	673	724	774	825	889	952	1016	1079	1143	1219	1295	1371	1460	1549	1651	1.43
497	548	586	637	687	738	802	866	929	993	1056	1132	1209	1285	1374	1463	1564	1.43
443	494	532	583	634	685	748	812	875	939	1003	1079	1155	1231	1320	1409	1511	1.43
471	522	560	611	661	712	776	840	903	967	1030	1106	1183	1259	1348	1437	1538	1.44
546	597	635	686	736	787	851	914	978	1041	1105	1181	1257	1333	1422	1511	1613	1.48
526	577	615	666	717	768	831	895	958	1022	1085	1161	1238	1314	1403	1492	1593	1.48
580	631	669	720	770	821	885	948	1012	1075	1139	1215	1291	1367	1456	1545	1647	1.50
564	615	653	704	754	805	869	932	996	1059	1123	1199	1275	1352	1441	1530	1631	1.50
514	565	603	654	705	756	819	883	946	1010	1073	1149	1226	1302	1391	1480	1581	1.51
530	581	619	670	720	771	835	899	962	1026	1089	1165	1242	1318	1407	1496	1597	1.56
550	601	639	690	740	791	855	918	982	1045	1109	1185	1261	1337	1426	1515	1617	1.57
386	438	476	527	578	629	693	756	820	883	947	1023	1100	1176	1265	1354	1455	1.57
301	353	391	443	494	545	609	673	736	800	864	940	1016	1093	1182	1271	1372	1.58
567	618	656	707	757	809	872	936	999	1063	1126	1202	1279	1355	1444	1533	1634	1.59
518	569	607	658	709	760	823	887	950	1014	1077	1153	1230	1306	1395	1484	1585	1.59
-	-	-	-	-	-	-	429	494	559	623	700	777	853	943	1032	1134	1.59
506	557	595	646	697	748	811	875	938	1002	1065	1141	1218	1294	1383	1472	1574	1.61
480	532	570	621	671	722	786	849	913	977	1040	1116	1193	1269	1358	1447	1548	1.61
454	505	543	595	645	696	760	823	887	951	1014	1090	1167	1243	1332	1421	1522	1.61
534	585	623	674	724	775	839	902	966	1029	1093	1169	1245	1321	1411	1500	1601	1.66
394	445	483	535	585	636	700	764	827	891	955	1031	1107	1183	1272	1361	1463	1.67
570	621	659	710	761	812	875	939	1002	1066	1129	1205	1282	1358	1447	1536	1637	1.68
553	604	642	693	744	795	859	922	986	1049	1113	1189	1265	1341	1430	1519	1621	1.68
522	573	611	662	712	763	827	890	954	1018	1081	1157	1234	1310	1399	1488	1589	1.68
510	561	599	650	700	752	815	879	942	1006	1069	1145	1222	1298	1387	1476	1577	1.69
537	588	626	678	728	779	843	906	970	1033	1097	1173	1249	1325	1414	1503	1605	1.76
315	367	406	457	508	560	624	687	751	815	879	955	1032	1108	1197	1286	1388	1.76
556	607	645	697	747	798	862	925	989	1052	1116	1192	1268	1344	1433	1522	1624	1.77
525	577	615	666	716	767	831	894	958	1021	1085	1161	1238	1314	1403	1492	1593	1.78
513	565	603	654	704	755	819	882	946	1010	1073	1149	1226	1302	1391	1480	1581	1.79
464	515	553	604	655	706	770	833	897	960	1024	1100	1177	1253	1342	1431	1532	1.79
401	452	491	542	593	644	708	771	835	899	962	1038	1115	1191	1280	1369	1471	1.79
489	541	579	630	680	731	795	859	922	986	1049	1125	1202	1278	1367	1456	1558	1.81
559	611	649	700	750	801	865	928	992	1055	1119	1195	1271	1347	1436	1525	1627	1.88
541	592	630	681	732	783	847	910	974	1037	1101	1177	1253	1329	1418	1507	1609	1.88
529	580	618	669	720	771	835	898	962	1025	1089	1165	1241	1317	1406	1495	1597	1.89
517	568	606	658	708	759	823	886	950	1013	1077	1153	1230	1306	1395	1484	1585	1.89
493	544	582	634	684	735	799	862	926	990	1053	1129	1206	1282	1371	1460	1561	1.91
329	381	420	472	523	574	638	702	766	830	894	970	1047	1123	1212	1301	1403	1.98
544	595	633	684	735	786	850	913	977	1040	1104	1180	1256	1332	1421	1510	1612	1.99
-	-	-	-	-	-	408	474	539	605	669	746	824	901	991	1080	1182	2.00
-	-	-	-	-	-	-	-	-	-	503	583	662	740	830	921	1024	2.00
497	548	586	637	688	739	803	866	930	993	1057	1133	1210	1286	1375	1464	1565	2.01
473	524	562	613	664	715	779	842	906	970	1033	1109	1186	1262	1351	1440	1542	2.01
412	463	502	553	604	655	719	782	846	910	973	1050	1126	1202	1291	1381	1482	2.01
-	-	313	366	418	471	535	600	664	728	792	869	946	1022	1112	1201	1303	2.01
533	584	622	673	724	775	838	902	966	1029	1093	1169	1245	1321	1410	1499	1601	2.02
521	572	610	661	712	763	827	890	954	1017	1081	1157	1233	1309	1398	1487	1589	2.02
547	598	636	687	738	789	853	916	980	1043	1107	1183	1259	1335	1424	1513	1615	2.11
336	388	427	479	530	581	646	709	773	837	901	977	1054	1130	1219	1309	1410	2.11
476	528	566	617	668	719	783	846	910	973	1037	1113	1190	1266	1355	1444	1545	2.12
536	587	625	676	727	778	841	905	969	1032	1096	1172	1248	1324	1413	1502	1604	2.13
501	552	590	641	692	743	806	870	934	997	1061	1137	1213	1289	1379	1468	1569	2.13
525	576	614	665	716	767	830	894	957	1021	1085	1161	1237	1313	1402	1491	1593	2.15
-	-	326	380	432	484	549	614	679	743	807	884	961	1037	1127	1216	1318	2.23
480	531	570	621	671	723	786	850	914	977	1041	1117	1193	1270	1359	1448	1549	2.24
421	473	511	562	613	665	728	792	856	920	983	1059	1136	1212	1301	1390	1492	2.25
539	590	628	679	730	781	845	908	972	1035	1099	1175	1251	1327	1416	1505	1607	2.26
342	395	434	486	537	589	653	717	781	845	908	985	1062	1138	1227	1316	1418	2.26
504	556	594	645	695	747	810	874	937	1001	1065	1141	1217	1293	1382	1471	1573	2.27
528	579	617	668	719	770	833	897	961	1024	1088	1164	1240	1316	1405	1494	1596	2.28
484	535	573	625	675	726	790	854	917	981	1045	1121	1197	1273	1362	1452	1553	2.37
531	582	620	671	722	773	836	900	964	1027	1091	1167	1243	1319	1408	1497	1599	2.41
508	559	597	649	699	750	814	878	941	1005	1068	1145	1221	1297	1386	1475	1577	2.42
-	298	339	393	446	498	563	628	693	757	821	898	975	1052	1141	1231	1333	2.51
-	-	-	-	-	373	441	508	574	639	704	782	860	937	1027	1117	1219	2.51
487	539	577	628	679	730	794	857	921	985	1048	1124	1201	1277	1366	1455	1557	2.52
430	481	520	571	622	673	737	801	865	929	992	1068	1145	1221	1310	1400	1501	2.52



● 3V·3VX (SR = 2.53 ~ 9.56)

Table 2-41-3 Drive Selection Table

Speed ratio	Effective diameter (mm)		Center distance (mm)													
	Small pulley	Large pulley	3V	3V	3V	3V	3V	3V	3V	3V	3V	3V	3V	3V	3V	
			250	265	280	300	315	335	355	375	400	425	450	475	500	530
2.53	125	315	-	-	-	-	-	-	-	-	-	-	-	239	273	313
2.53	250	630	-	-	-	-	-	-	-	-	-	-	-	-	-	-
2.56	71	180	-	-	148	175	195	222	248	274	306	338	370	403	434	473
2.65	95	250	-	-	-	-	-	-	-	190	224	257	290	323	356	394
2.68	150	400	-	-	-	-	-	-	-	-	-	-	-	-	-	-
2.69	75	200	-	-	-	152	173	200	226	253	285	318	350	382	414	453
2.72	67	180	-	-	151	178	198	224	251	277	309	341	373	406	437	476
2.79	180	500	-	-	-	-	-	-	-	-	-	-	-	-	-	-
2.80	90	250	-	-	-	-	-	-	-	193	227	261	294	327	359	398
2.83	112	315	-	-	-	-	-	-	-	-	-	-	-	247	281	322
2.85	71	200	-	-	-	155	175	202	229	256	288	321	353	385	417	456
2.87	140	400	-	-	-	-	-	-	-	-	-	-	-	-	-	-
2.97	85	250	-	-	-	-	-	-	-	196	230	264	297	330	363	401
3.02	67	200	-	-	-	157	178	205	232	258	291	323	356	388	420	458
3.14	160	500	-	-	-	-	-	-	-	-	-	-	-	-	-	-
3.16	80	250	-	-	-	-	-	-	-	199	233	267	300	333	366	405
3.16	200	630	-	-	-	-	-	-	-	-	-	-	-	-	-	-
3.18	100	315	-	-	-	-	-	-	-	-	-	-	219	255	289	330
3.22	125	400	-	-	-	-	-	-	-	-	-	-	-	-	-	-
3.35	95	315	-	-	-	-	-	-	-	-	-	-	222	258	292	333
3.35	150	500	-	-	-	-	-	-	-	-	-	-	-	-	-	-
3.37	75	250	-	-	-	-	-	-	174	202	237	271	304	337	369	408
3.52	180	630	-	-	-	-	-	-	-	-	-	-	-	-	-	-
3.53	90	315	-	-	-	-	-	-	-	-	-	-	225	261	295	336
3.56	71	250	-	-	-	-	-	-	176	205	239	273	306	340	372	411
3.59	140	500	-	-	-	-	-	-	-	-	-	-	-	-	-	-
3.60	112	400	-	-	-	-	-	-	-	-	-	-	-	-	-	-
3.74	85	315	-	-	-	-	-	-	-	-	-	-	228	264	299	339
3.78	67	250	-	-	-	-	-	-	179	207	242	276	309	342	375	414
3.96	160	630	-	-	-	-	-	-	-	-	-	-	-	-	-	-
3.98	80	315	-	-	-	-	-	-	-	-	-	-	231	267	302	343
4.03	125	500	-	-	-	-	-	-	-	-	-	-	-	-	-	-
4.04	100	400	-	-	-	-	-	-	-	-	-	-	-	-	-	-
4.23	150	630	-	-	-	-	-	-	-	-	-	-	-	-	-	-
4.25	75	315	-	-	-	-	-	-	-	-	-	-	234	271	305	346
4.25	95	400	-	-	-	-	-	-	-	-	-	-	-	-	-	-
4.49	90	400	-	-	-	-	-	-	-	-	-	-	-	-	-	-
4.50	71	315	-	-	-	-	-	-	-	-	-	-	237	273	308	348
4.50	112	500	-	-	-	-	-	-	-	-	-	-	-	-	-	-
4.53	140	630	-	-	-	-	-	-	-	-	-	-	-	-	-	-
4.76	85	400	-	-	-	-	-	-	-	-	-	-	-	-	-	-
4.77	67	315	-	-	-	-	-	-	-	-	-	202	239	276	310	351
5.05	100	500	-	-	-	-	-	-	-	-	-	-	-	-	-	-
5.06	80	400	-	-	-	-	-	-	-	-	-	-	-	-	-	-
5.08	125	630	-	-	-	-	-	-	-	-	-	-	-	-	-	-
5.32	95	500	-	-	-	-	-	-	-	-	-	-	-	-	-	-
5.40	75	400	-	-	-	-	-	-	-	-	-	-	-	-	-	-
5.62	90	500	-	-	-	-	-	-	-	-	-	-	-	-	-	-
5.68	112	630	-	-	-	-	-	-	-	-	-	-	-	-	-	-
5.71	71	400	-	-	-	-	-	-	-	-	-	-	-	-	-	249
5.95	85	500	-	-	-	-	-	-	-	-	-	-	-	-	-	-
6.06	67	400	-	-	-	-	-	-	-	-	-	-	-	-	-	251
6.33	80	500	-	-	-	-	-	-	-	-	-	-	-	-	-	-
6.36	100	630	-	-	-	-	-	-	-	-	-	-	-	-	-	-
6.70	95	630	-	-	-	-	-	-	-	-	-	-	-	-	-	-
6.76	75	500	-	-	-	-	-	-	-	-	-	-	-	-	-	-
7.08	90	630	-	-	-	-	-	-	-	-	-	-	-	-	-	-
7.15	71	500	-	-	-	-	-	-	-	-	-	-	-	-	-	-
7.50	85	630	-	-	-	-	-	-	-	-	-	-	-	-	-	-
7.58	67	500	-	-	-	-	-	-	-	-	-	-	-	-	-	-
7.98	80	630	-	-	-	-	-	-	-	-	-	-	-	-	-	-
8.52	75	630	-	-	-	-	-	-	-	-	-	-	-	-	-	-
9.01	71	630	-	-	-	-	-	-	-	-	-	-	-	-	-	-
9.56	67	630	-	-	-	-	-	-	-	-	-	-	-	-	-	-

2

Design

3V-3VX

2.53 ~ 9.56

Color coding of Power rating correction factor : Kc

0.7	0.8	0.9	1.0	1.1	1.2
-----	-----	-----	-----	-----	-----

Center distance (mm)																	Speed ratio
3V 560	3V 600	3V 630	3V 670	3V 710	3V 750	3V 800	3V 850	3V 900	3V 950	3V 1000	3V 1060	3V 1120	3V 1180	3V 1250	3V 1320	3V 1400	
353	405	444	496	548	599	664	728	792	856	920	996	1073	1149	1238	1328	1429	2.53
-	-	-	-	-	-	-	-	-	478	546	626	706	784	876	967	1070	2.53
511	562	600	652	702	753	817	881	944	1008	1071	1148	1224	1300	1389	1478	1580	2.56
433	485	523	575	626	677	741	805	869	932	996	1072	1149	1225	1314	1403	1505	2.65
-	304	345	399	452	505	570	635	700	764	829	905	983	1059	1149	1238	1340	2.68
491	542	581	632	683	734	798	861	925	989	1052	1128	1205	1281	1370	1459	1561	2.69
514	565	603	655	705	756	820	884	947	1011	1075	1151	1227	1303	1392	1481	1583	2.72
-	-	-	-	-	385	454	521	587	653	718	796	874	951	1041	1131	1234	2.79
437	488	527	578	629	681	745	809	872	936	1000	1076	1153	1229	1318	1407	1509	2.80
361	414	453	505	557	609	673	737	801	865	929	1006	1082	1159	1248	1337	1439	2.83
494	545	584	635	686	737	801	864	928	992	1055	1131	1208	1284	1373	1462	1564	2.85
-	311	352	406	459	512	577	642	707	771	836	913	990	1066	1156	1246	1348	2.87
440	492	530	582	633	684	748	812	876	940	1004	1080	1156	1233	1322	1411	1513	2.97
497	548	587	638	689	740	804	867	931	995	1058	1134	1211	1287	1376	1465	1567	3.02
-	-	-	-	341	398	467	534	601	666	732	810	888	965	1055	1146	1248	3.14
444	496	534	586	637	688	752	816	880	943	1007	1083	1160	1236	1326	1415	1516	3.16
-	-	-	-	-	-	-	-	438	509	578	659	739	818	910	1002	1105	3.16
369	422	462	514	565	617	682	746	810	874	938	1014	1091	1168	1257	1346	1448	3.18
-	320	362	416	469	522	588	653	717	782	846	923	1001	1077	1167	1257	1359	3.23
373	426	465	517	569	621	685	749	814	878	942	1018	1095	1171	1261	1350	1452	3.35
-	-	-	-	347	404	473	541	607	673	739	817	895	972	1063	1153	1255	3.35
447	499	538	589	640	692	756	820	883	947	1011	1087	1164	1240	1329	1419	1520	3.37
-	-	-	-	-	-	-	-	451	522	591	672	753	832	924	1015	1119	3.52
376	429	468	521	572	624	689	753	817	881	945	1022	1099	1175	1264	1354	1456	3.53
450	502	540	592	643	695	759	823	886	950	1014	1090	1167	1243	1332	1422	1523	3.56
-	-	-	-	353	410	480	547	614	680	746	824	902	979	1070	1160	1263	3.59
271	328	370	424	478	531	596	662	727	791	856	933	1010	1087	1177	1266	1368	3.60
379	433	472	524	576	628	692	757	821	885	949	1025	1102	1179	1268	1357	1459	3.74
453	505	543	595	646	698	762	825	889	953	1017	1093	1170	1246	1335	1425	1526	3.78
-	-	-	-	-	-	-	-	463	534	604	685	766	845	938	1029	1133	3.96
383	436	475	528	579	631	696	760	824	888	953	1029	1106	1182	1272	1361	1463	3.98
-	-	-	-	362	420	489	557	624	690	756	834	912	990	1080	1171	1273	4.03
278	336	377	432	486	539	605	670	735	800	864	941	1019	1096	1185	1275	1377	4.04
-	-	-	-	-	-	-	-	469	541	610	692	773	852	944	1036	1140	4.23
386	439	479	531	583	635	699	764	828	892	956	1033	1110	1186	1276	1365	1467	4.25
281	339	381	436	489	542	608	673	738	803	868	945	1022	1099	1189	1279	1381	4.25
284	342	384	439	492	546	612	677	742	807	871	948	1026	1103	1193	1282	1384	4.49
389	442	481	534	586	638	702	767	831	895	959	1036	1113	1189	1279	1368	1470	4.50
-	-	-	-	370	428	498	566	633	699	765	843	921	999	1079	1180	1283	4.50
-	-	-	-	-	-	-	400	475	547	617	698	779	859	951	1043	1147	4.53
287	345	387	442	496	549	615	680	745	810	875	952	1030	1106	1196	1286	1388	4.76
391	445	484	537	588	640	705	769	834	898	962	1039	1116	1192	1281	1371	1473	4.77
-	-	-	317	377	435	505	573	641	707	773	851	930	1007	1098	1188	1291	5.05
290	348	390	445	499	552	618	684	749	814	878	956	1033	1110	1200	1290	1392	5.06
-	-	-	-	-	-	-	408	484	556	626	708	789	869	961	1053	1157	5.08
-	-	-	320	380	438	508	577	644	710	776	855	933	1011	1102	1192	1295	5.32
293	351	393	448	502	556	622	687	752	817	882	959	1037	1114	1203	1293	1395	5.40
-	-	-	322	383	442	512	580	647	714	780	858	937	1014	1105	1196	1298	5.62
-	-	-	-	-	-	-	416	492	564	634	716	798	878	970	1062	1166	5.68
295	354	396	451	505	558	624	690	755	820	885	962	1040	1116	1206	1296	1398	5.71
-	-	-	325	386	445	515	583	650	717	783	862	940	1018	1109	1199	1302	5.95
298	356	398	454	507	561	627	693	758	823	888	965	1042	1119	1209	1299	1401	6.06
-	-	-	328	389	448	518	586	654	720	786	865	944	1021	1112	1203	1306	6.33
-	-	-	-	-	-	-	423	499	572	642	724	806	886	978	1070	1175	6.36
-	-	-	-	-	-	-	426	502	575	645	727	809	889	982	1074	1178	6.70
-	-	-	331	392	451	521	590	657	724	790	868	947	1025	1116	1206	1309	6.76
-	-	-	-	-	-	-	429	505	578	648	731	812	892	985	1077	1182	7.08
-	-	-	334	395	453	524	592	660	726	793	871	950	1028	1118	1209	1312	7.15
-	-	-	-	-	-	-	432	508	581	651	734	815	895	988	1081	1185	7.50
-	-	-	336	397	456	526	595	662	729	795	874	953	1030	1121	1212	1315	7.58
-	-	-	-	-	-	-	435	511	584	655	737	819	899	992	1084	1189	7.98
-	-	-	-	-	-	-	438	514	587	658	740	822	902	995	1087	1192	8.52
-	-	-	-	-	-	-	440	517	590	660	743	825	905	998	1090	1195	9.01
-	-	-	-	-	-	-	443	519	592	663	745	827	907	1000	1093	1197	9.56

2
Design



● 5V-5VX (SR = 1.00 ~ 1.27)

Table 2-42-1 Drive Selection Table

Speed ratio	Effective diameter (mm)		Center distance (mm)															
	Small pulley	Large pulley	5V	5V	5V	5V	5V	5V	5V	5V	5V	5V	5V	5V	5V	5V	5V	5V
			500	530	560	600	630	670	710	750	800	850	900	950	1000	1060	1120	1180
1.00	150	150	399	437	475	526	564	615	666	717	780	844	907	971	1034	1110	1187	1263
1.00	160	160	384	422	460	511	549	600	650	701	765	828	892	955	1019	1095	1171	1247
1.00	170	170	368	406	444	495	533	584	634	685	749	812	876	939	1003	1079	1155	1231
1.00	180	180	352	390	428	479	517	568	619	670	733	797	860	924	987	1063	1140	1216
1.00	190	190	337	375	413	464	502	553	603	654	718	781	845	908	972	1048	1124	1200
1.00	200	200	321	359	397	448	486	537	587	638	702	765	829	892	956	1032	1108	1184
1.00	212	212	302	340	378	429	467	518	568	619	683	746	810	873	937	1013	1089	1165
1.00	224	224	283	321	359	410	448	499	550	601	664	728	791	855	918	994	1071	1147
1.00	236	236	264	302	340	391	429	480	531	582	645	709	772	836	899	975	1052	1128
1.00	250	250	-	280	318	369	407	458	509	560	623	687	750	814	877	953	1030	1106
1.00	265	265	-	-	295	346	384	435	485	536	600	663	727	790	854	930	1006	1082
1.00	280	280	-	-	-	322	360	411	462	513	576	640	703	767	830	906	983	1059
1.00	300	300	-	-	-	-	329	380	430	481	545	608	672	735	799	875	951	1027
1.00	315	315	-	-	-	-	-	356	407	458	521	585	648	712	775	851	928	1004
1.00	355	355	-	-	-	-	-	-	-	395	458	522	585	649	712	788	865	941
1.00	400	400	-	-	-	-	-	-	-	-	-	451	515	578	642	718	794	870
1.00	450	450	-	-	-	-	-	-	-	-	-	-	-	500	563	639	716	792
1.00	500	500	-	-	-	-	-	-	-	-	-	-	-	-	-	561	637	713
1.05	190	200	329	367	405	456	494	545	595	646	710	773	837	900	964	1040	1116	1192
1.05	224	236	274	312	350	401	439	490	540	591	655	718	782	845	909	985	1061	1137
1.05	300	315	-	-	-	-	-	368	418	469	533	596	660	723	787	863	939	1015
1.06	160	170	376	414	452	503	541	592	642	693	757	820	884	947	1011	1087	1163	1239
1.06	170	180	360	398	436	487	525	576	627	678	741	805	868	932	995	1071	1148	1224
1.06	180	190	344	382	420	471	509	560	611	662	725	789	852	916	979	1055	1132	1208
1.06	200	212	311	349	387	438	476	527	578	629	692	756	819	883	946	1022	1099	1175
1.06	212	224	293	331	369	420	458	509	559	610	674	737	801	864	928	1004	1080	1156
1.06	236	250	253	291	329	380	418	469	520	571	634	698	761	825	888	964	1041	1117
1.06	250	265	-	268	306	357	395	446	497	548	611	675	738	802	865	941	1018	1094
1.06	265	280	-	-	283	334	372	423	473	524	588	651	715	778	842	918	994	1070
1.07	150	160	391	429	467	519	557	608	658	709	773	836	900	963	1027	1103	1179	1255
1.07	280	300	-	-	-	306	344	395	446	497	560	624	687	751	814	890	967	1043
1.11	180	200	336	374	412	463	501	552	603	654	717	781	844	908	971	1048	1124	1200
1.11	212	236	283	321	359	410	448	499	550	601	664	728	791	855	918	994	1071	1147
1.11	450	500	-	-	-	-	-	-	-	-	-	-	-	-	523	599	676	752
1.12	170	190	352	390	428	479	517	568	619	670	733	797	860	924	987	1063	1140	1216
1.12	190	212	319	357	395	446	484	535	586	637	700	764	827	891	954	1030	1107	1183
1.12	200	224	302	340	378	429	467	518	568	619	683	746	810	873	937	1013	1089	1165
1.12	224	250	262	300	338	390	428	479	529	580	644	707	771	834	898	974	1050	1126
1.12	236	265	-	279	317	368	406	457	508	559	622	686	749	813	876	952	1029	1105
1.12	250	280	-	-	294	345	383	434	485	536	600	663	727	790	854	930	1006	1082
1.13	160	180	368	406	444	495	533	584	634	685	749	812	876	939	1003	1079	1155	1231
1.13	265	300	-	-	-	318	356	407	457	508	572	636	699	763	826	902	979	1055
1.13	280	315	-	-	-	-	332	383	434	485	548	612	675	739	802	879	955	1031
1.13	315	355	-	-	-	-	-	-	375	426	489	553	616	680	744	820	896	972
1.13	355	400	-	-	-	-	-	-	-	-	422	486	550	613	677	753	829	905
1.13	400	450	-	-	-	-	-	-	-	-	-	-	475	538	602	678	754	831
1.14	150	170	384	422	460	511	549	600	650	701	765	828	892	955	1019	1095	1171	1247
1.18	170	200	344	382	420	471	509	560	611	662	725	789	852	916	979	1055	1132	1208
1.18	180	212	327	365	403	454	492	543	593	644	708	771	835	898	962	1038	1115	1191
1.18	190	224	309	347	385	437	475	526	576	627	691	754	818	881	945	1021	1097	1173
1.18	200	236	292	330	368	419	457	508	559	610	673	737	800	864	927	1003	1080	1156
1.18	212	250	271	310	348	399	437	488	538	589	653	716	780	843	907	983	1059	1135
1.18	300	355	-	-	-	-	-	-	386	437	501	564	628	692	755	831	908	984
1.19	160	190	360	398	436	487	525	576	626	677	741	804	868	931	995	1071	1148	1224
1.19	224	265	-	288	326	377	415	466	517	568	632	695	759	822	886	962	1038	1114
1.19	236	280	-	-	305	356	394	445	496	547	610	674	737	801	864	940	1017	1093
1.19	265	315	-	-	-	305	344	395	445	496	560	623	687	751	814	890	967	1043
1.20	150	180	376	414	452	503	541	592	642	693	757	820	884	947	1011	1087	1163	1239
1.25	250	300	-	-	-	329	367	418	469	520	583	647	711	774	838	914	990	1066
1.25	160	200	352	390	428	479	517	568	618	669	733	797	860	924	987	1063	1140	1216
1.25	170	212	334	372	410	462	500	551	601	652	716	779	843	906	970	1046	1122	1198
1.25	180	224	317	355	393	444	482	533	584	635	698	762	825	889	952	1028	1105	1181
1.25	190	236	300	338	376	427	465	516	566	617	681	745	808	872	935	1011	1088	1164
1.25	200	250	280	319	357	408	446	497	548	599	662	726	789	853	916	992	1069	1145
1.25	212	265	259	297	335	386	425	476	526	577	641	704	768	831	895	971	1048	1124
1.25	224	280	-	276	314	365	403	454	505	556	620	683	747	810	874	950	1026	1102
1.25	400	500	-	-	-	-	-	-	-	-	-	-	-	497	561	637	714	790
1.26	250	315	-	-	-	317	355	406	457	508	571	635	698	762	826	902	978	1054
1.26	500	630	-	-	-	-	-	-	-	-	-	-	-	-	-	-	-	608
1.27	150	190	367	405	444	495	533	584	634	685	749	812	876	939	1003	1079	1155	1231

2

Design

5V·5VX

1.00 ~ 1.27

Color coding of Power rating correction factor : Kc

0.7	0.8	0.9	1.0	1.1	1.2
-----	-----	-----	-----	-----	-----

Center distance (mm)																		Speed ratio	
5V 1250	5V 1320	5V 1400	5V 1500	5V 1600	5V 1700	5V 1800	5V 1900	5V 2000	5V 2120	5V 2240	5V 2360	5V 2500	5V 2650	5V 2800	5V 3000	5V 3150	5V 3350		5V 3550
1352	1441	1542	1669	1796	1923	2050	2177	2304	2457	2609	2761	2939	3130	3320	3574	3765	4019	4273	1.00
1336	1425	1527	1654	1781	1908	2035	2162	2289	2441	2594	2746	2924	3114	3305	3559	3749	4003	4257	1.00
1320	1409	1511	1638	1765	1892	2019	2146	2273	2425	2578	2730	2908	3098	3289	3543	3733	3987	4241	1.00
1305	1394	1495	1622	1749	1876	2003	2130	2257	2410	2562	2714	2892	3083	3273	3527	3718	3972	4226	1.00
1289	1378	1480	1607	1734	1861	1988	2115	2242	2394	2547	2699	2877	3067	3258	3512	3702	3956	4210	1.00
1273	1362	1464	1591	1718	1845	1972	2099	2226	2378	2531	2683	2861	3051	3242	3496	3686	3940	4194	1.00
1254	1343	1445	1572	1699	1826	1953	2080	2207	2359	2512	2664	2842	3032	3223	3477	3667	3921	4175	1.00
1236	1325	1426	1553	1680	1807	1934	2061	2188	2341	2493	2645	2823	3014	3204	3458	3649	3903	4157	1.00
1217	1306	1407	1534	1661	1788	1915	2042	2169	2322	2474	2626	2804	2995	3185	3439	3630	3884	4138	1.00
1195	1284	1385	1512	1639	1766	1893	2020	2147	2300	2452	2604	2782	2973	3163	3417	3608	3862	4116	1.00
1171	1260	1362	1489	1616	1743	1870	1997	2124	2276	2429	2581	2759	2949	3140	3394	3584	3838	4092	1.00
1148	1237	1338	1465	1592	1719	1846	1973	2100	2253	2405	2557	2735	2926	3116	3370	3561	3815	4069	1.00
1116	1205	1307	1434	1561	1688	1815	1942	2069	2221	2374	2526	2704	2894	3085	3339	3529	3783	4037	1.00
1093	1182	1283	1410	1537	1664	1791	1918	2045	2198	2350	2502	2680	2871	3061	3315	3506	3760	4014	1.00
1030	1119	1220	1347	1474	1601	1728	1855	1982	2135	2287	2439	2617	2808	2998	3252	3443	3697	3951	1.00
959	1048	1150	1277	1404	1531	1658	1785	1912	2064	2217	2369	2547	2737	2928	3182	3372	3626	3880	1.00
881	970	1071	1198	1325	1452	1579	1706	1833	1986	2138	2290	2468	2659	2849	3103	3294	3548	3802	1.00
802	891	993	1120	1247	1374	1501	1628	1755	1907	2060	2212	2390	2580	2771	3025	3215	3469	3723	1.00
1281	1370	1472	1599	1726	1853	1980	2107	2234	2386	2539	2691	2869	3059	3250	3504	3694	3948	4202	1.05
1226	1315	1417	1544	1671	1798	1925	2052	2179	2331	2484	2636	2814	3004	3195	3449	3639	3893	4147	1.05
1104	1193	1295	1422	1549	1676	1803	1930	2057	2209	2362	2514	2692	2882	3073	3327	3517	3771	4025	1.05
1328	1417	1519	1646	1773	1900	2027	2154	2281	2433	2586	2738	2916	3106	3297	3551	3741	3995	4249	1.06
1313	1402	1503	1630	1757	1884	2011	2138	2265	2418	2570	2722	2900	3091	3281	3535	3726	3980	4234	1.06
1297	1386	1487	1614	1741	1868	1995	2122	2249	2402	2554	2706	2884	3075	3265	3519	3710	3964	4218	1.06
1264	1353	1454	1581	1708	1835	1962	2089	2216	2369	2521	2673	2851	3042	3232	3486	3677	3931	4185	1.06
1245	1334	1436	1563	1690	1817	1944	2071	2198	2350	2503	2655	2833	3023	3214	3468	3658	3912	4166	1.06
1206	1295	1396	1523	1650	1777	1904	2031	2158	2311	2463	2615	2793	2984	3174	3428	3619	3873	4127	1.06
1183	1272	1373	1501	1628	1755	1882	2009	2136	2288	2441	2593	2771	2961	3152	3406	3596	3850	4104	1.06
1159	1248	1350	1477	1604	1731	1858	1985	2112	2264	2417	2569	2747	2937	3128	3382	3572	3826	4080	1.06
1344	1433	1535	1662	1789	1916	2043	2170	2297	2449	2602	2754	2932	3122	3313	3567	3757	4011	4265	1.07
1132	1221	1322	1449	1576	1703	1830	1957	2084	2237	2389	2541	2719	2910	3100	3354	3545	3799	4053	1.07
1289	1378	1480	1607	1734	1861	1988	2115	2242	2394	2547	2699	2877	3067	3258	3512	3702	3956	4210	1.11
1236	1325	1426	1553	1680	1807	1934	2061	2188	2341	2493	2645	2823	3014	3204	3458	3649	3903	4157	1.11
841	930	1032	1159	1286	1413	1540	1667	1794	1946	2099	2251	2429	2619	2810	3064	3254	3508	3762	1.11
1305	1394	1495	1622	1749	1876	2003	2130	2257	2410	2562	2714	2892	3083	3273	3527	3718	3972	4226	1.12
1272	1361	1462	1589	1716	1843	1970	2097	2224	2377	2529	2681	2859	3050	3240	3494	3685	3939	4193	1.12
1254	1343	1445	1572	1699	1826	1953	2080	2207	2359	2512	2664	2842	3032	3223	3477	3667	3921	4175	1.12
1215	1304	1406	1533	1660	1787	1914	2041	2168	2320	2473	2625	2803	2993	3184	3438	3628	3882	4136	1.12
1194	1283	1384	1511	1638	1765	1892	2019	2146	2299	2451	2603	2781	2972	3162	3416	3607	3861	4115	1.12
1171	1260	1362	1489	1616	1743	1870	1997	2124	2276	2429	2581	2759	2949	3140	3394	3584	3838	4092	1.12
1320	1409	1511	1638	1765	1892	2019	2146	2273	2425	2578	2730	2908	3098	3289	3543	3733	3987	4241	1.13
1144	1233	1334	1461	1588	1715	1842	1969	2096	2249	2401	2553	2731	2922	3112	3366	3557	3811	4065	1.13
1120	1209	1311	1438	1565	1692	1819	1946	2073	2225	2378	2530	2708	2898	3089	3343	3533	3787	4041	1.13
1061	1150	1252	1379	1506	1633	1760	1887	2014	2166	2319	2471	2649	2839	3030	3284	3474	3728	3982	1.13
994	1083	1185	1312	1439	1566	1693	1820	1947	2099	2252	2404	2582	2772	2963	3217	3407	3661	3915	1.13
920	1009	1110	1237	1364	1491	1618	1745	1872	2025	2177	2329	2507	2698	2888	3142	3333	3587	3841	1.13
1336	1425	1527	1654	1781	1908	2035	2162	2289	2441	2594	2746	2924	3114	3305	3559	3749	4003	4257	1.14
1297	1386	1487	1614	1741	1868	1995	2122	2249	2402	2554	2706	2884	3075	3265	3519	3710	3964	4218	1.18
1280	1369	1470	1597	1724	1851	1978	2105	2232	2385	2537	2689	2867	3058	3248	3502	3693	3947	4201	1.18
1262	1351	1453	1580	1707	1834	1961	2088	2215	2367	2520	2672	2850	3040	3231	3485	3675	3929	4183	1.18
1245	1334	1435	1562	1689	1816	1943	2070	2197	2350	2503	2655	2833	3023	3214	3468	3658	3912	4166	1.18
1224	1314	1415	1542	1669	1796	1923	2050	2177	2330	2482	2634	2812	3003	3193	3447	3638	3892	4146	1.18
1073	1162	1263	1390	1517	1644	1771	1898	2025	2178	2330	2482	2660	2851	3041	3295	3486	3740	3994	1.18
1313	1402	1503	1630	1757	1884	2011	2138	2265	2418	2570	2722	2900	3091	3281	3535	3726	3980	4234	1.19
1203	1292	1394	1521	1648	1775	1902	2029	2156	2308	2461	2613	2791	2981	3172	3426	3616	3870	4124	1.19
1182	1271	1373	1500	1627	1754	1881	2008	2135	2287	2440	2592	2770	2960	3151	3405	3595	3849	4103	1.19
1132	1221	1322	1449	1576	1703	1830	1957	2084	2237	2389	2541	2719	2910	3100	3354	3545	3799	4053	1.19
1328	1417	1519	1646	1773	1900	2027	2154	2281	2433	2586	2738	2916	3106	3297	3551	3741	3995	4249	1.20
1155	1244	1346	1473	1600	1727	1854	1981	2108	2260	2413	2565	2743	2933	3124	3378	3568	3822	4076	1.25
1305	1394	1495	1622	1749	1876	2003	2130	2257	2410	2562	2714	2892	3083	3273	3527	3718	3972	4226	1.25
1287	1376	1478	1605	1732	1859	1986	2113	2240	2392	2545	2697	2875	3065	3256	3510	3700	3954	4208	1.25
1270	1359	1461	1588	1715	1842	1969	2096	2223	2375	2528	2680	2858	3048	3239	3493	3683	3937	4191	1.25
1253	1342	1443	1570	1697	1824	1951	2078	2205	2358	2510	2662	2840	3031	3221	3475	3666	3920	4174	1.25
1234	1323	1424	1551	1678	1805	1932	2059	2186	2339	2491	2643	2821							

● 5V·5VX (SR = 1.27 ~ 1.87)

Table 2-42-2 Drive Selection Table

Speed ratio	Effective diameter (mm)		Center distance (mm)															
	Small pulley	Large pulley	5V	5V	5V	5V	5V	5V	5V	5V	5V	5V	5V	5V	5V	5V	5V	5V
			500	530	560	600	630	670	710	750	800	850	900	950	1000	1060	1120	1180
1.27	236	300	-	-	288	340	378	429	479	531	594	658	721	785	848	924	1001	1077
1.27	280	355	-	-	-	-	-	350	401	452	516	580	643	707	770	846	923	999
1.27	315	400	-	-	-	-	-	-	-	389	452	516	580	644	707	783	860	936
1.27	355	450	-	-	-	-	-	-	-	-	-	445	509	572	636	712	789	865
1.32	170	224	324	363	401	452	490	541	591	642	706	770	833	897	960	1036	1113	1189
1.32	180	236	307	345	383	434	472	524	574	625	689	752	816	879	943	1019	1095	1171
1.32	190	250	288	326	364	415	453	505	555	606	670	733	797	860	924	1000	1077	1153
1.32	212	280	-	285	323	374	412	463	514	565	629	692	756	819	883	959	1036	1112
1.33	160	212	342	380	418	469	507	558	609	660	723	787	850	914	977	1054	1130	1206
1.33	200	265	268	306	344	395	434	485	535	586	650	714	777	841	904	980	1057	1133
1.34	150	200	359	397	435	486	525	576	626	677	741	804	868	931	995	1071	1147	1223
1.34	224	300	-	-	297	348	387	438	488	540	603	667	730	794	858	934	1010	1086
1.34	236	315	-	-	-	327	365	416	467	518	582	646	709	773	836	912	989	1065
1.34	265	355	-	-	-	-	-	361	412	463	527	591	655	718	782	858	934	1011
1.34	300	400	-	-	-	-	-	-	-	400	464	527	591	655	718	795	871	947
1.39	170	236	314	353	391	442	480	531	582	633	696	760	823	887	951	1027	1103	1179
1.39	180	250	295	333	372	423	461	512	563	614	677	741	805	868	932	1008	1084	1160
1.40	190	265	275	313	352	403	441	492	543	594	658	721	785	848	912	988	1064	1141
1.40	450	630	-	-	-	-	-	-	-	-	-	-	-	-	-	-	567	644
1.41	160	224	332	370	408	459	497	548	599	650	714	777	841	904	968	1044	1120	1196
1.41	200	280	255	293	332	383	421	472	523	574	638	701	765	829	892	968	1045	1121
1.41	224	315	-	-	284	336	374	425	476	527	591	655	718	782	845	922	998	1074
1.41	355	500	-	-	-	-	-	-	-	-	-	-	466	530	594	671	747	824
1.42	150	212	349	387	426	477	515	566	616	667	731	795	858	922	985	1061	1138	1214
1.42	212	300	-	267	306	357	395	447	497	549	612	676	740	803	867	943	1019	1095
1.42	250	355	-	-	-	-	321	372	423	474	538	602	666	729	793	869	946	1022
1.43	280	400	-	-	-	-	-	-	362	414	478	542	606	670	733	810	886	963
1.43	315	450	-	-	-	-	-	-	-	-	410	474	538	602	666	742	819	895
1.48	160	236	322	360	398	449	488	539	589	640	704	768	831	895	958	1034	1111	1187
1.48	170	250	302	341	379	430	468	520	570	621	685	749	812	876	939	1015	1092	1168
1.48	180	265	282	321	359	410	448	500	550	601	665	729	792	856	920	996	1072	1148
1.48	190	280	262	300	339	390	428	480	530	582	645	709	773	836	900	976	1052	1128
1.49	212	315	-	-	293	344	383	434	485	536	600	664	727	791	855	931	1007	1083
1.50	150	224	339	377	416	467	505	556	607	658	721	785	848	912	976	1052	1128	1204
1.50	300	450	-	-	-	-	-	-	-	-	420	485	549	613	677	753	830	906
1.51	200	300	-	276	314	366	404	456	506	558	621	685	749	812	876	952	1029	1105
1.51	236	355	-	-	-	-	330	382	433	485	549	612	676	740	804	880	956	1033
1.51	265	400	-	-	-	-	-	-	373	425	489	553	617	681	745	821	898	974
1.56	180	280	269	308	346	398	436	487	538	589	653	716	780	844	907	983	1060	1136
1.57	160	250	310	348	386	438	476	527	578	629	693	756	820	883	947	1023	1100	1176
1.57	170	265	289	328	366	418	456	507	558	609	673	736	800	864	927	1003	1080	1156
1.58	150	236	329	367	406	457	495	546	597	648	712	775	839	902	966	1042	1119	1195
1.58	200	315	-	-	301	353	391	443	494	545	609	673	736	800	864	940	1016	1093
1.58	400	630	-	-	-	-	-	-	-	-	-	-	-	-	-	-	603	680
1.59	190	300	-	283	321	373	411	463	514	565	629	692	756	820	883	960	1036	1112
1.59	224	355	-	-	-	300	339	391	442	493	557	621	685	749	813	889	966	1042
1.59	315	500	-	-	-	-	-	-	-	-	-	429	494	559	623	700	777	853
1.60	500	800	-	-	-	-	-	-	-	-	-	-	-	-	-	-	-	-
1.61	250	400	-	-	-	-	-	-	384	436	500	564	628	692	756	832	909	985
1.61	280	450	-	-	-	-	-	-	-	-	434	499	563	627	691	768	845	921
1.66	170	280	276	315	353	405	443	495	545	597	660	724	788	851	915	991	1068	1144
1.67	160	265	297	335	374	425	463	515	565	616	680	744	807	871	935	1011	1087	1164
1.67	190	315	-	269	308	360	398	450	501	552	616	680	744	807	871	947	1024	1100
1.67	300	500	-	-	-	-	-	-	-	-	-	440	505	569	634	711	788	864
1.68	150	250	317	355	394	445	483	535	585	636	700	764	827	891	955	1031	1107	1183
1.68	180	300	251	290	329	380	419	470	521	572	636	700	764	827	891	967	1044	1120
1.68	212	355	-	-	-	308	347	399	451	502	566	630	694	758	822	898	975	1051
1.70	236	400	-	-	-	-	-	342	393	445	510	574	638	702	766	842	919	996
1.71	265	450	-	-	-	-	-	-	380	445	510	574	638	702	779	856	932	1009
1.76	160	280	283	322	360	412	450	502	553	604	668	731	795	859	922	999	1075	1151
1.76	180	315	-	276	315	367	406	457	508	560	624	687	751	815	879	955	1032	1108
1.78	150	265	304	342	381	432	471	522	573	624	688	751	815	879	942	1018	1095	1171
1.78	170	300	258	297	336	387	426	477	528	580	644	707	771	835	899	975	1051	1127
1.78	355	630	-	-	-	-	-	-	-	-	-	-	-	-	-	555	634	712
1.78	450	800	-	-	-	-	-	-	-	-	-	-	-	-	-	-	-	-
1.79	200	355	-	-	-	317	356	408	459	511	575	639	703	767	830	907	984	1060
1.79	224	400	-	-	-	-	-	350	402	454	518	583	647	711	775	851	928	1005
1.79	280	500	-	-	-	-	-	-	-	-	-	454	519	584	648	725	802	879
1.81	250	450	-	-	-	-	-	-	390	455	520	585	649	713	790	867	943	1019
1.87	170	315	-	283	322	374	413	464	515	567	631	695	759	822	886	962	1039	1115

2

Design

5V·5VX

1.27 ~ 1.87

Color coding of Power rating correction factor : Kc

0.7	0.8	0.9	1.0	1.1	1.2
-----	-----	-----	-----	-----	-----

Center distance (mm)																		Speed ratio	
5V 1250	5V 1320	5V 1400	5V 1500	5V 1600	5V 1700	5V 1800	5V 1900	5V 2000	5V 2120	5V 2240	5V 2360	5V 2500	5V 2650	5V 2800	5V 3000	5V 3150	5V 3350		5V 3550
1166	1255	1357	1484	1611	1738	1865	1992	2119	2271	2424	2576	2754	2944	3135	3389	3579	3833	4087	1.27
1088	1177	1279	1406	1533	1660	1787	1914	2041	2193	2346	2498	2676	2867	3057	3311	3502	3756	4010	1.27
1025	1114	1216	1343	1470	1597	1724	1851	1978	2131	2283	2435	2613	2804	2994	3248	3439	3693	3947	1.27
954	1043	1145	1272	1399	1526	1653	1780	1907	2060	2212	2364	2542	2733	2923	3177	3368	3622	3876	1.27
1278	1367	1468	1595	1722	1849	1976	2103	2230	2383	2535	2687	2865	3056	3246	3500	3691	3945	4199	1.32
1260	1349	1451	1578	1705	1832	1959	2086	2213	2366	2518	2670	2848	3039	3229	3483	3674	3928	4182	1.32
1242	1331	1432	1559	1686	1813	1940	2067	2194	2347	2499	2651	2829	3020	3210	3464	3655	3909	4163	1.32
1201	1290	1391	1518	1645	1772	1899	2026	2153	2306	2458	2610	2788	2979	3169	3423	3614	3868	4122	1.32
1295	1384	1486	1613	1740	1867	1994	2121	2248	2400	2553	2705	2883	3073	3264	3518	3708	3962	4216	1.33
1222	1311	1412	1539	1666	1793	1921	2048	2175	2327	2480	2632	2810	3000	3191	3445	3635	3889	4143	1.33
1312	1401	1503	1630	1757	1884	2011	2138	2265	2417	2570	2722	2900	3091	3281	3535	3726	3980	4234	1.34
1175	1264	1366	1493	1620	1747	1874	2001	2128	2281	2433	2585	2763	2954	3144	3398	3589	3843	4097	1.34
1154	1243	1345	1472	1599	1726	1853	1980	2107	2259	2412	2564	2742	2932	3123	3377	3568	3822	4076	1.34
1100	1189	1290	1417	1544	1671	1798	1926	2053	2205	2358	2510	2688	2878	3069	3323	3513	3767	4021	1.34
1037	1126	1227	1354	1481	1608	1736	1863	1990	2142	2295	2447	2625	2815	3006	3260	3450	3704	3958	1.34
1268	1357	1459	1586	1713	1840	1967	2094	2221	2373	2526	2678	2856	3046	3237	3491	3681	3935	4189	1.39
1249	1338	1440	1567	1694	1821	1948	2075	2202	2355	2507	2659	2837	3028	3218	3472	3663	3917	4171	1.39
1230	1319	1420	1547	1674	1801	1928	2055	2182	2335	2487	2639	2817	3008	3198	3452	3643	3897	4151	1.40
734	823	925	1053	1180	1308	1435	1562	1689	1842	1995	2147	2325	2516	2706	2960	3151	3405	3659	1.40
1286	1375	1476	1603	1730	1857	1984	2111	2238	2391	2543	2695	2873	3064	3254	3508	3699	3953	4207	1.41
1210	1299	1400	1527	1655	1782	1909	2036	2163	2315	2468	2620	2798	2988	3179	3433	3623	3877	4131	1.41
1163	1252	1354	1481	1608	1735	1862	1989	2116	2269	2421	2573	2751	2942	3132	3386	3577	3831	4085	1.41
913	1002	1104	1231	1359	1486	1613	1740	1867	2020	2172	2324	2502	2693	2884	3138	3328	3582	3836	1.41
1303	1392	1493	1620	1747	1874	2001	2128	2255	2408	2560	2713	2891	3081	3272	3526	3716	3970	4224	1.42
1185	1274	1375	1502	1629	1756	1883	2010	2137	2290	2442	2595	2773	2963	3154	3408	3598	3852	4106	1.42
1111	1200	1302	1429	1556	1683	1810	1937	2064	2217	2369	2521	2699	2890	3080	3334	3525	3779	4033	1.42
1052	1141	1242	1370	1497	1624	1751	1878	2005	2158	2310	2462	2640	2831	3021	3275	3466	3720	3974	1.43
984	1074	1175	1302	1430	1557	1684	1811	1938	2091	2243	2395	2573	2764	2954	3208	3399	3653	3907	1.43
1276	1365	1466	1594	1721	1848	1975	2102	2229	2381	2534	2686	2864	3054	3245	3499	3689	3943	4197	1.48
1257	1346	1448	1575	1702	1829	1956	2083	2210	2362	2515	2667	2845	3035	3226	3480	3670	3924	4178	1.48
1237	1326	1428	1555	1682	1809	1936	2063	2190	2343	2495	2647	2825	3016	3206	3460	3651	3905	4159	1.48
1218	1307	1408	1535	1662	1789	1916	2043	2170	2323	2475	2627	2806	2996	3187	3441	3631	3885	4139	1.48
1172	1262	1363	1490	1617	1744	1871	1998	2125	2278	2431	2583	2761	2951	3142	3396	3586	3840	4094	1.49
1293	1382	1484	1611	1738	1865	1992	2119	2246	2398	2551	2703	2881	3072	3262	3516	3707	3961	4215	1.50
996	1085	1187	1314	1441	1568	1695	1822	1950	2102	2255	2407	2585	2775	2966	3220	3411	3665	3919	1.50
1194	1283	1384	1511	1639	1766	1893	2020	2147	2299	2452	2604	2782	2972	3163	3417	3607	3861	4115	1.51
1122	1211	1312	1440	1567	1694	1821	1948	2075	2228	2380	2532	2710	2901	3091	3345	3536	3790	4044	1.51
1063	1152	1254	1381	1508	1635	1762	1890	2017	2169	2322	2474	2652	2842	3033	3287	3478	3732	3986	1.51
1225	1314	1416	1543	1670	1797	1924	2051	2178	2331	2483	2635	2813	3004	3194	3448	3639	3893	4147	1.56
1265	1354	1455	1582	1709	1836	1963	2091	2218	2370	2523	2675	2853	3043	3234	3488	3678	3932	4186	1.57
1245	1334	1436	1563	1690	1817	1944	2071	2198	2350	2503	2655	2833	3023	3214	3468	3659	3913	4167	1.57
1284	1373	1474	1601	1728	1855	1982	2109	2236	2389	2541	2693	2872	3062	3253	3507	3697	3951	4205	1.58
1182	1271	1372	1499	1627	1754	1881	2008	2135	2287	2440	2592	2770	2960	3151	3405	3596	3850	4104	1.58
770	860	962	1090	1218	1345	1473	1600	1727	1880	2033	2185	2363	2554	2745	2999	3189	3444	3698	1.58
1201	1290	1392	1519	1646	1773	1900	2027	2154	2307	2460	2612	2790	2980	3171	3425	3615	3869	4123	1.59
1131	1220	1322	1449	1576	1703	1830	1957	2084	2237	2389	2541	2719	2910	3101	3355	3545	3799	4053	1.59
943	1032	1134	1262	1389	1516	1643	1770	1898	2050	2203	2355	2533	2724	2914	3169	3359	3613	3867	1.59
-	-	742	871	1000	1128	1256	1384	1512	1665	1818	1970	2149	2340	2531	2785	2976	3230	3484	1.60
1074	1164	1265	1392	1520	1647	1774	1901	2028	2181	2333	2485	2663	2854	3045	3299	3489	3743	3997	1.61
1011	1100	1202	1329	1456	1583	1711	1838	1965	2117	2270	2422	2600	2791	2981	3236	3426	3680	3934	1.61
1233	1322	1424	1551	1678	1805	1932	2059	2186	2338	2491	2643	2821	3012	3202	3456	3647	3901	4155	1.66
1253	1342	1443	1570	1697	1824	1951	2079	2206	2358	2511	2663	2841	3031	3222	3476	3666	3920	4174	1.67
1189	1278	1380	1507	1634	1761	1888	2015	2142	2295	2448	2600	2778	2968	3159	3413	3603	3857	4111	1.67
954	1043	1145	1273	1400	1527	1655	1782	1909	2062	2214	2367	2545	2735	2926	3180	3371	3625	3879	1.67
1272	1361	1463	1590	1717	1844	1971	2098	2225	2378	2530	2682	2860	3051	3241	3495	3686	3940	4194	1.68
1209	1298	1400	1527	1654	1781	1908	2035	2162	2315	2467	2619	2797	2988	3178	3432	3623	3877	4131	1.68
1140	1229	1331	1458	1585	1712	1839	1966	2093	2246	2399	2551	2729	2919	3110	3364	3554	3809	4063	1.68
1085	1174	1276	1403	1530	1657	1785	1912	2039	2191	2344	2496	2674	2865	3055	3309	3500	3754	4008	1.70
1022	1111	1213	1340	1468	1595	1722	1849	1976	2129	2282	2434	2612	2802	2993	3247	3438	3692	3946	1.71
1240	1330	1431	1558	1685	1812	1939	2067	2194	2346	2499	2651	2829	3019	3210	3464	3654	3908	4162	1.76
1197	1286	1388	1515	1642	1769	1896	2023	2150	2303	2455	2607	2785	2976	3167	3421	3611	3865	4119	1.76
1260	1349	1451	1578	1705	1832	1959	2086	2213	2366	2518	2670	2848	3039	3230	3484	3674	3928	4182	1.78
1217	1306	1407	1534	1662	1789	1916	2043	2170	2322	2475	2627	2805	2996	3186	3440	3631	3885	4139	1.78
802	892	995	1123	1251	1379	1506	1634	1761	1914	2067	2219	2397	2588	2779					

● 5V-5VX (SR = 1.88 ~ 3.80)

Table 2-42-3 Drive Selection Table

Speed ratio	Effective diameter (mm)		Center distance (mm)															
	Small pulley	Large pulley	5V	5V	5V	5V	5V	5V	5V	5V	5V	5V	5V	5V	5V	5V	5V	5V
			500	530	560	600	630	670	710	750	800	850	900	950	1000	1060	1120	1180
1.88	150	280	290	329	368	419	458	509	560	611	675	739	803	866	930	1006	1083	1159
1.88	190	355	-	-	-	323	363	415	466	518	582	646	710	774	838	914	991	1067
1.89	160	300	264	304	343	395	433	485	536	587	651	715	779	842	906	982	1059	1135
1.90	212	400	-	-	-	-	-	358	410	462	527	591	656	720	784	860	937	1013
1.90	265	500	-	-	-	-	-	-	-	-	398	464	529	594	659	736	813	890
1.92	236	450	-	-	-	-	-	-	-	399	465	530	595	659	723	800	877	954
1.98	160	315	250	290	329	381	420	472	523	574	638	702	766	830	894	970	1047	1123
1.99	180	355	-	-	-	330	369	422	473	525	589	653	717	781	845	922	998	1075
2.01	200	400	-	-	-	-	313	366	418	471	535	600	664	728	792	869	946	1022
2.01	250	500	-	-	-	-	-	-	-	-	408	474	539	605	669	746	824	901
2.01	315	630	-	-	-	-	-	-	-	-	-	-	-	-	503	583	662	740
2.01	400	800	-	-	-	-	-	-	-	-	-	-	-	-	-	-	-	-
2.01	500	1000	-	-	-	-	-	-	-	-	-	-	-	-	-	-	-	-
2.02	150	300	271	311	350	402	440	492	543	594	658	722	786	850	913	990	1066	1143
2.02	224	450	-	-	-	-	-	-	354	407	473	538	603	668	732	809	886	963
2.11	170	355	-	-	284	337	376	429	480	532	596	661	725	789	853	929	1006	1082
2.11	300	630	-	-	-	-	-	-	-	-	-	-	-	-	513	593	672	750
2.12	150	315	257	296	336	388	427	479	530	581	646	709	773	837	901	977	1054	1130
2.12	190	400	-	-	-	-	319	373	425	478	542	607	671	736	800	876	953	1030
2.13	236	500	-	-	-	-	-	-	-	-	417	483	549	614	679	756	834	911
2.14	212	450	-	-	-	-	-	-	362	416	481	547	611	676	741	817	895	971
2.23	450	1000	-	-	-	-	-	-	-	-	-	-	-	-	-	-	-	-
2.24	160	355	-	-	290	344	383	436	487	539	604	668	732	796	860	936	1013	1090
2.24	180	400	-	-	-	-	326	380	432	484	549	614	679	743	807	884	961	1037
2.25	224	500	-	-	-	-	-	-	-	-	425	491	557	623	688	765	843	920
2.26	280	630	-	-	-	-	-	-	-	-	-	-	-	-	526	606	685	764
2.26	355	800	-	-	-	-	-	-	-	-	-	-	-	-	-	-	-	-
2.27	200	450	-	-	-	-	-	-	370	424	490	555	620	685	749	826	903	980
2.37	170	400	-	-	-	-	332	386	439	491	556	621	686	750	814	891	968	1044
2.38	212	500	-	-	-	-	-	-	-	-	433	500	565	631	696	773	851	928
2.39	150	355	-	-	297	350	390	443	494	546	611	675	739	803	867	944	1021	1097
2.39	190	450	-	-	-	-	-	-	376	430	496	562	627	692	756	833	911	987
2.39	265	630	-	-	-	-	-	-	-	-	-	-	-	468	536	616	696	774
2.51	400	1000	-	-	-	-	-	-	-	-	-	-	-	-	-	-	-	-
2.51	500	1250	-	-	-	-	-	-	-	-	-	-	-	-	-	-	-	-
2.52	160	400	-	-	-	298	339	393	446	498	563	628	693	757	821	898	975	1052
2.52	180	450	-	-	-	-	-	328	383	437	503	569	634	699	763	840	918	995
2.52	200	500	-	-	-	-	-	-	-	373	441	508	574	639	704	782	860	937
2.54	250	630	-	-	-	-	-	-	-	-	-	-	-	478	546	626	706	784
2.55	315	800	-	-	-	-	-	-	-	-	-	-	-	-	-	-	-	571
2.65	190	500	-	-	-	-	-	-	-	379	447	514	580	646	711	789	867	944
2.67	170	450	-	-	-	-	-	335	389	443	510	576	641	706	770	847	925	1002
2.68	300	800	-	-	-	-	-	-	-	-	-	-	-	-	-	-	-	581
2.69	236	630	-	-	-	-	-	-	-	-	-	-	-	486	555	635	715	794
2.70	150	400	-	-	-	304	345	399	452	505	570	635	700	764	829	905	983	1059
2.79	450	1250	-	-	-	-	-	-	-	-	-	-	-	-	-	-	-	-
2.80	180	500	-	-	-	-	-	-	-	385	454	521	587	653	718	796	874	951
2.83	224	630	-	-	-	-	-	-	-	-	-	-	-	494	563	643	723	802
2.83	355	1000	-	-	-	-	-	-	-	-	-	-	-	-	-	-	-	-
2.54	160	450	-	-	-	-	-	341	396	450	517	582	648	713	777	855	932	1009
2.87	280	800	-	-	-	-	-	-	-	-	-	-	-	-	-	-	-	593
2.97	170	500	-	-	-	-	-	-	-	392	460	527	594	660	725	803	881	958
3.00	212	630	-	-	-	-	-	-	-	-	-	-	431	502	570	651	731	810
3.04	150	450	-	-	-	-	-	347	402	457	523	589	655	720	784	862	939	1016
3.04	265	800	-	-	-	-	-	-	-	-	-	-	-	-	-	-	-	603
3.14	400	1250	-	-	-	-	-	-	-	-	-	-	-	-	-	-	-	-
3.16	160	500	-	-	-	-	-	-	341	398	467	534	601	666	732	810	888	965
3.18	200	630	-	-	-	-	-	-	-	-	-	-	438	509	578	659	739	818
3.19	315	1000	-	-	-	-	-	-	-	-	-	-	-	-	-	-	-	-
3.22	250	800	-	-	-	-	-	-	-	-	-	-	-	-	-	-	-	612
3.35	190	630	-	-	-	-	-	-	-	-	-	-	445	516	585	666	746	825
3.35	300	1000	-	-	-	-	-	-	-	-	-	-	-	-	-	-	-	-
3.37	150	500	-	-	-	-	-	-	347	404	473	541	607	673	739	817	895	972
3.42	236	800	-	-	-	-	-	-	-	-	-	-	-	-	-	-	534	621
3.54	180	630	-	-	-	-	-	-	-	-	-	-	451	522	591	672	753	832
3.54	355	1250	-	-	-	-	-	-	-	-	-	-	-	-	-	-	-	-
3.60	224	800	-	-	-	-	-	-	-	-	-	-	-	-	-	-	542	628
3.60	280	1000	-	-	-	-	-	-	-	-	-	-	-	-	-	-	-	-
3.75	170	630	-	-	-	-	-	-	-	-	-	-	457	528	597	679	759	839
3.80	265	1000	-	-	-	-	-	-	-	-	-	-	-	-	-	-	-	-

2

Design

5V·5VX

1.88 ~ 3.80

Color coding of Power rating correction factor : Kc

0.7	0.8	0.9	1.0	1.1	1.2
-----	-----	-----	-----	-----	-----

Center distance (mm)																		Speed ratio	
5V 1250	5V 1320	5V 1400	5V 1500	5V 1600	5V 1700	5V 1800	5V 1900	5V 2000	5V 2120	5V 2240	5V 2360	5V 2500	5V 2650	5V 2800	5V 3000	5V 3150	5V 3350		5V 3550
1248	1337	1439	1566	1693	1820	1947	2074	2201	2354	2506	2658	2837	3027	3218	3472	3662	3916	4170	1.88
1157	1246	1347	1475	1602	1729	1856	1983	2110	2263	2416	2568	2746	2936	3127	3381	3572	3826	4080	1.88
1224	1313	1415	1542	1669	1796	1923	2051	2178	2330	2483	2635	2813	3003	3194	3448	3639	3893	4147	1.89
1103	1192	1294	1421	1548	1676	1803	1930	2057	2210	2362	2515	2693	2883	3074	3328	3519	3773	4027	1.90
980	1069	1171	1299	1426	1554	1681	1808	1936	2088	2241	2393	2571	2762	2953	3207	3398	3652	3906	1.90
1043	1133	1235	1362	1489	1617	1744	1871	1998	2151	2304	2456	2634	2825	3015	3269	3460	3714	3968	1.92
1212	1301	1403	1530	1657	1784	1911	2038	2166	2318	2471	2623	2801	2991	3182	3436	3627	3881	4135	1.98
1164	1253	1355	1482	1609	1737	1864	1991	2118	2271	2423	2575	2753	2944	3135	3389	3579	3833	4087	1.99
1112	1201	1303	1430	1558	1685	1812	1939	2066	2219	2372	2524	2702	2893	3083	3337	3528	3782	4036	2.01
991	1080	1182	1310	1438	1565	1692	1820	1947	2100	2252	2405	2583	2774	2964	3219	3409	3663	3917	2.01
830	921	1024	1152	1280	1408	1536	1663	1791	1944	2097	2249	2428	2619	2809	3064	3254	3509	3763	2.01
612	706	811	941	1071	1200	1328	1457	1585	1739	1892	2045	2224	2415	2606	2861	3051	3306	3560	2.01
-	-	-	-	816	948	1079	1209	1339	1493	1648	1802	1981	2173	2365	2620	2811	3066	3321	2.01
1232	1321	1423	1550	1677	1804	1931	2058	2185	2338	2490	2643	2821	3011	3202	3456	3646	3900	4154	2.02
1052	1142	1244	1371	1498	1626	1753	1880	2007	2160	2313	2465	2643	2834	3025	3279	3469	3723	3978	2.02
1172	1261	1363	1490	1617	1744	1871	1999	2126	2278	2431	2583	2761	2952	3142	3396	3587	3841	4095	2.11
841	931	1034	1163	1291	1419	1547	1674	1802	1955	2108	2261	2439	2630	2821	3075	3266	3520	3774	2.11
1219	1309	1410	1538	1665	1792	1919	2046	2173	2326	2478	2630	2809	2999	3190	3444	3634	3888	4142	2.12
1119	1209	1310	1438	1565	1692	1820	1947	2074	2227	2379	2531	2710	2900	3091	3345	3536	3790	4044	2.12
1001	1090	1193	1320	1448	1575	1703	1830	1957	2110	2263	2415	2594	2784	2975	3229	3420	3674	3928	2.13
1061	1150	1252	1380	1507	1635	1762	1889	2017	2169	2322	2474	2652	2843	3034	3288	3479	3733	3987	2.14
-	-	-	-	849	982	1113	1244	1374	1529	1684	1838	2017	2210	2401	2657	2848	3103	3358	2.23
1179	1268	1370	1497	1625	1752	1879	2006	2133	2286	2439	2591	2769	2959	3150	3404	3595	3849	4103	2.24
1127	1216	1318	1445	1573	1700	1827	1954	2082	2234	2387	2539	2717	2908	3099	3353	3543	3797	4051	2.24
1009	1099	1201	1329	1457	1584	1712	1839	1967	2119	2272	2424	2603	2793	2984	3238	3429	3683	3937	2.25
855	946	1049	1177	1306	1434	1561	1689	1817	1970	2123	2276	2454	2645	2836	3090	3281	3535	3790	2.26
642	736	841	972	1102	1232	1361	1489	1618	1771	1925	2078	2257	2448	2639	2894	3085	3340	3594	2.26
1070	1159	1261	1389	1516	1644	1771	1898	2026	2178	2331	2483	2662	2852	3043	3297	3488	3742	3996	2.27
1134	1223	1325	1453	1580	1707	1835	1962	2089	2242	2395	2547	2725	2916	3106	3360	3551	3805	4059	2.37
1018	1108	1210	1338	1466	1593	1721	1848	1976	2128	2281	2434	2612	2803	2993	3248	3438	3692	3947	2.38
1186	1276	1378	1505	1632	1759	1887	2014	2141	2294	2446	2598	2776	2967	3158	3412	3602	3857	4111	2.39
1077	1167	1269	1396	1524	1651	1779	1906	2033	2186	2339	2491	2669	2860	3051	3305	3495	3750	4004	2.39
865	956	1059	1188	1316	1445	1572	1700	1828	1981	2134	2287	2465	2656	2847	3102	3293	3547	3801	2.39
-	-	-	745	881	1015	1147	1278	1408	1564	1719	1873	2054	2246	2438	2694	2885	3141	3396	2.51
-	-	-	-	-	-	-	966	1102	1262	1421	1578	1761	1955	2149	2406	2599	2855	3111	2.51
1141	1231	1333	1460	1588	1715	1842	1970	2097	2249	2402	2554	2733	2923	3114	3368	3559	3813	4067	2.52
1084	1174	1276	1404	1531	1659	1786	1913	2041	2194	2346	2499	2677	2868	3058	3312	3503	3757	4011	2.52
1027	1117	1219	1347	1475	1602	1730	1857	1985	2137	2290	2443	2621	2812	3002	3257	3447	3702	3956	2.52
876	967	1070	1199	1327	1455	1583	1711	1839	1992	2145	2298	2477	2668	2859	3113	3304	3558	3813	2.54
668	762	868	1000	1130	1260	1389	1518	1646	1800	1954	2107	2286	2478	2669	2924	3115	3370	3625	2.55
1034	1124	1226	1354	1482	1610	1737	1865	1992	2145	2298	2450	2629	2819	3010	3264	3455	3709	3964	2.65
1092	1181	1283	1411	1539	1666	1794	1921	2048	2201	2354	2506	2684	2875	3066	3320	3511	3765	4019	2.67
677	772	878	1010	1141	1270	1400	1529	1657	1811	1965	2118	2297	2489	2680	2935	3127	3381	3636	2.68
885	976	1080	1209	1337	1466	1594	1722	1849	2003	2156	2308	2487	2678	2869	3124	3314	3569	3823	2.69
1149	1238	1340	1468	1595	1722	1850	1977	2104	2257	2410	2562	2740	2931	3122	3376	3566	3820	4075	2.70
-	-	-	-	-	-	-	998	1134	1296	1455	1612	1795	1990	2184	2442	2635	2892	3148	2.79
1041	1131	1234	1362	1489	1617	1745	1872	2000	2152	2305	2458	2636	2827	3018	3272	3463	3717	3971	2.80
894	985	1088	1217	1346	1474	1602	1730	1858	2012	2165	2317	2496	2687	2878	3133	3324	3578	3832	2.83
-	-	-	774	911	1045	1178	1309	1440	1596	1751	1905	2086	2278	2471	2727	2918	3174	3429	2.83
1099	1189	1291	1418	1546	1674	1801	1928	2056	2209	2361	2514	2692	2883	3073	3328	3518	3773	4027	2.84
690	785	892	1024	1154	1284	1414	1543	1672	1826	1980	2133	2312	2504	2695	2950	3142	3396	3651	2.87
1048	1138	1241	1369	1497	1624	1752	1880	2007	2160	2313	2465	2644	2834	3025	3280	3470	3725	3979	2.97
902	993	1097	1226	1355	1483	1611	1739	1867	2020	2174	2326	2505	2696	2887	3142	3333	3587	3842	3.00
1106	1196	1298	1426	1554	1681	1809	1936	2063	2216	2369	2521	2700	2890	3081	3335	3526	3780	4034	3.04
700	795	902	1034	1165	1295	1424	1554	1682	1837	1991	2144	2323	2515	2706	2961	3153	3408	3662	3.04
-	-	-	-	-	-	888	1029	1167	1329	1488	1646	1830	2025	2219	2478	2671	2928	3184	3.14
1055	1146	1248	1376	1504	1632	1759	1887	2014	2167	2320	2473	2651	2842	3033	3287	3478	3732	3987	3.16
910	1002	1105	1234	1363	1492	1620	1748	1876	2029	2183	2335	2514	2705	2896	3151	3342	3596	3851	3.18
-	-	-	799	937	1071	1205	1336	1467	1624	1779	1934	2114	2307	2500	2756	2948	3203	3459	3.19
710	805	912	1044	1175	1305	1435	1564	1693	1847	2001	2155	2334	2526	2717	2973	3164	3419	3674	3.22
917	1008	1112	1241	1370	1499	1627	1755	1883	2037	2190	2343	2521	2713	2904	3158	3349	3604	3858	3.35
-	-	665	808	946	1081	1215	1346	1478	1634	1790	1944	2125	2318	2511	2767	2959	3214	3470	3.35
1063	1153	1255	1383	1511	1639	1767	1894	2022	2175	2328	2480	2659	2850	3040	3295	3486	3740	3994	3.37
718	814	921	1054	1185	1315	1445	1574	1703	1857	2012	2165	2344	2536	2728	2983	3174	3429	3684	3.42
924	1015	1119	1249	1377	1506	1634	1762	1890	2044	2197	2350	2529	2720	2911	3166	3357</			

● 5V·5VX (SR =3.81 ~ 8.46)

Table 2-42-4 Drive Selection Table

Speed ratio	Effective diameter (mm)		Center distance (mm)															
			5V	5V	5V	5V	5V	5V	5V	5V	5V	5V	5V	5V	5V	5V	5V	5V
	Small pulley	Large pulley	500	530	560	600	630	670	710	750	800	850	900	950	1000	1060	1120	1180
1.00	300	300	-	-	-	-	-	-	-	-	-	-	-	-	-	-	549	636
1.00	315	315	-	-	-	-	-	-	-	-	-	-	463	534	604	685	766	845
1.00	335	335	-	-	-	-	-	-	-	-	-	-	-	-	-	-	-	-
1.00	355	355	-	-	-	-	-	-	-	-	-	-	-	-	-	-	-	-
1.00	375	375	-	-	-	-	-	-	-	-	-	-	-	-	-	-	556	643
1.00	400	400	-	-	-	-	-	-	-	-	-	-	-	-	-	-	-	-
1.00	425	425	-	-	-	-	-	-	-	-	-	-	469	541	610	692	773	852
1.00	450	450	-	-	-	-	-	-	-	-	-	-	-	-	-	-	562	649
1.00	475	475	-	-	-	-	-	-	-	-	-	-	-	-	-	-	-	-
1.00	500	500	-	-	-	-	-	-	-	-	-	-	-	-	-	-	568	656
1.00	560	560	-	-	-	-	-	-	-	-	-	-	-	-	-	-	-	-
1.00	630	630	-	-	-	-	-	-	-	-	-	-	-	-	-	-	-	-
1.00	710	710	-	-	-	-	-	-	-	-	-	-	-	-	-	-	-	-
1.00	800	800	-	-	-	-	-	-	-	-	-	-	-	-	-	-	574	662
1.05	300	315	-	-	-	-	-	-	-	-	-	-	-	-	-	-	-	-
1.05	475	500	-	-	-	-	-	-	-	-	-	-	-	-	-	-	-	-
1.06	315	335	-	-	-	-	-	-	-	-	-	-	-	-	-	-	-	-
1.06	335	355	-	-	-	-	-	-	-	-	-	-	-	-	-	-	580	668
1.06	355	375	-	-	-	-	-	-	-	-	-	-	-	-	-	-	-	-
1.06	400	425	-	-	-	-	-	-	-	-	-	-	-	-	-	-	-	-
1.06	425	450	-	-	-	-	-	-	-	-	-	-	-	-	493	586	674	-
1.06	450	475	-	-	-	-	-	-	-	-	-	-	-	-	-	-	-	-
1.07	375	400	-	-	-	-	-	-	-	-	-	-	-	-	-	-	-	-
1.11	450	500	-	-	-	-	-	-	-	-	-	-	-	-	-	-	-	-
1.12	300	335	-	-	-	-	-	-	-	-	-	-	-	-	-	-	-	-
1.12	335	375	-	-	-	-	-	-	-	-	-	-	-	-	-	-	-	-
1.12	425	475	-	-	-	-	-	-	-	-	-	-	-	-	-	-	-	-
1.12	500	560	-	-	-	-	-	-	-	-	-	-	-	-	-	-	-	-
1.13	315	355	-	-	-	-	-	-	-	-	-	-	-	-	-	-	-	-
1.13	355	400	-	-	-	-	-	-	-	-	-	-	-	-	-	-	-	-
1.13	400	450	-	-	-	-	-	-	-	-	-	-	-	-	-	-	-	-
1.13	560	630	-	-	-	-	-	-	-	-	-	-	-	-	-	-	-	-
1.44	315	450	-	-	-	-	-	-	-	-	-	-	-	-	-	-	-	-

2
Design

5V·5VX

3.81 ~ 8.46

Color coding of Power rating correction factor : Kc

0.7	0.8	0.9	1.0	1.1	1.2
-----	-----	-----	-----	-----	-----

Center distance (mm)																	Speed ratio		
5V 1250	5V 1320	5V 1400	5V 1500	5V 1600	5V 1700	5V 1800	5V 1900	5V 2000	5V 2120	5V 2240	5V 2360	5V 2500	5V 2650	5V 2800	5V 3000	5V 3150		5V 3350	5V 3550
734	830	937	1070	1201	1332	1462	1591	1720	1875	2029	2182	2362	2554	2745	3001	3192	3447	3702	3.81
938	1029	1133	1263	1392	1520	1649	1777	1905	2059	2212	2365	2544	2735	2926	3181	3372	3626	3881	3.99
-	-	-	-	-	-	941	1083	1221	1384	1545	1704	1888	2084	2279	2538	2731	2989	3246	3.99
-	-	695	839	978	1114	1248	1380	1512	1669	1825	1980	2161	2354	2547	2803	2995	3251	3507	4.03
741	837	945	1078	1209	1340	1470	1599	1729	1883	2038	2191	2371	2563	2754	3010	3201	3456	3711	4.04
-	-	-	-	-	801	950	1092	1231	1394	1555	1714	1898	2094	2289	2548	2742	3000	3256	4.19
944	1036	1140	1270	1399	1528	1656	1784	1912	2066	2219	2372	2551	2742	2934	3188	3379	3634	3888	4.26
748	844	952	1085	1216	1347	1477	1607	1736	1890	2045	2198	2378	2570	2762	3017	3208	3464	3718	4.26
-	-	704	848	987	1123	1257	1390	1521	1678	1834	1990	2171	2364	2557	2813	3005	3261	3517	4.27
754	850	958	1091	1223	1354	1484	1614	1743	1897	2052	2206	2385	2577	2769	3024	3216	3471	3726	4.49
-	-	711	856	995	1131	1265	1398	1529	1687	1843	1998	2179	2372	2565	2822	3014	3270	3526	4.50
-	-	-	-	-	813	962	1105	1244	1407	1568	1727	1912	2108	2303	2562	2756	3014	3271	4.50
-	-	-	-	-	821	971	1114	1253	1417	1578	1737	1922	2118	2314	2573	2767	3025	3282	4.75
760	857	965	1098	1230	1361	1491	1621	1750	1905	2059	2213	2392	2584	2776	3032	3223	3478	3733	4.76
-	-	718	863	1003	1139	1273	1406	1538	1695	1851	2006	2188	2381	2574	2831	3023	3279	3535	4.76
-	-	-	-	-	830	980	1124	1263	1427	1588	1747	1932	2129	2324	2584	2777	3035	3292	5.04
-	-	725	871	1010	1147	1281	1414	1546	1703	1859	2015	2196	2390	2583	2839	3032	3288	3543	5.05
767	863	971	1105	1237	1368	1498	1628	1757	1912	2066	2220	2400	2592	2784	3039	3231	3486	3741	5.07
-	607	731	877	1017	1153	1288	1421	1553	1710	1866	2022	2203	2397	2590	2847	3039	3295	3551	5.32
-	-	-	-	-	839	989	1132	1272	1436	1597	1757	1942	2138	2334	2593	2787	3045	3302	5.34
773	870	978	1111	1243	1374	1505	1635	1764	1919	2073	2227	2407	2599	2791	3047	3238	3493	3748	5.41
-	613	737	883	1023	1160	1294	1427	1559	1717	1873	2029	2210	2404	2597	2854	3046	3302	3558	5.62
-	-	-	-	-	846	996	1140	1279	1444	1605	1765	1950	2147	2342	2602	2796	3054	3311	5.63
-	618	743	889	1029	1166	1301	1434	1566	1724	1880	2036	2217	2411	2604	2861	3053	3310	3565	5.96
-	-	-	-	-	853	1004	1147	1287	1451	1613	1773	1958	2155	2350	2610	2804	3062	3320	5.96
-	-	-	-	-	860	1011	1155	1295	1459	1621	1781	1966	2163	2359	2619	2813	3071	3328	6.32
-	624	749	895	1036	1173	1307	1441	1573	1730	1887	2043	2224	2418	2611	2868	3061	3317	3573	6.34
-	-	-	-	-	866	1017	1161	1301	1466	1628	1787	1973	2170	2366	2626	2820	3078	3335	6.66
-	630	755	902	1042	1179	1314	1447	1580	1737	1894	2050	2231	2425	2618	2875	3068	3324	3580	6.77
-	-	-	-	-	872	1023	1167	1307	1472	1634	1794	1980	2177	2373	2633	2827	3085	3343	7.03
-	-	-	-	-	878	1029	1173	1314	1479	1641	1801	1986	2183	2379	2639	2834	3092	3350	7.45
-	-	-	-	718	883	1035	1180	1320	1485	1647	1807	1993	2190	2386	2646	2841	3099	3357	7.93
-	-	-	-	723	889	1041	1186	1326	1492	1654	1814	2000	2197	2393	2653	2848	3106	3364	8.46



● 8V (SR = 1.00 ~ 1.44)

Table 2-43-1 Drive Selection Table

Speed ratio	Effective diameter (mm)		Center distance (mm)													
	Small pulley	Large pulley	8V	8V	8V	8V	8V	8V	8V	8V	8V	8V	8V	8V	8V	8V
			1000	1060	1120	1180	1250	1320	1400	1500	1600	1700	1800	1900	2000	2120
1.00	300	300	799	875	951	1027	1116	1205	1307	1434	1561	1688	1815	1942	2069	2221
1.00	315	315	775	851	928	1004	1093	1182	1283	1410	1537	1664	1791	1918	2045	2198
1.00	335	335	744	820	896	972	1061	1150	1252	1379	1506	1633	1760	1887	2014	2166
1.00	355	355	712	788	865	941	1030	1119	1220	1347	1474	1601	1728	1855	1982	2135
1.00	375	375	681	757	833	909	998	1087	1189	1316	1443	1570	1697	1824	1951	2103
1.00	400	400	642	718	794	870	959	1048	1150	1277	1404	1531	1658	1785	1912	2064
1.00	425	425	602	678	755	831	920	1009	1110	1237	1364	1491	1618	1745	1872	2025
1.00	450	450	563	639	716	792	881	970	1071	1198	1325	1452	1579	1706	1833	1986
1.00	475	475	524	600	676	752	841	930	1032	1159	1286	1413	1540	1667	1794	1946
1.00	500	500	-	561	637	713	802	891	993	1120	1247	1374	1501	1628	1755	1907
1.00	560	560	-	-	-	619	708	797	898	1025	1152	1279	1406	1533	1660	1813
1.00	630	630	-	-	-	-	-	687	788	915	1042	1169	1296	1423	1550	1703
1.00	710	710	-	-	-	-	-	-	-	790	917	1044	1171	1298	1425	1577
1.00	800	800	-	-	-	-	-	-	-	-	-	902	1029	1156	1283	1436
1.05	300	315	787	863	939	1015	1104	1193	1295	1422	1549	1676	1803	1930	2057	2209
1.05	475	500	504	580	657	733	822	911	1012	1139	1266	1393	1520	1647	1774	1927
1.06	315	335	759	835	912	988	1077	1166	1267	1394	1521	1648	1775	1902	2029	2182
1.06	335	355	728	804	881	957	1046	1135	1236	1363	1490	1617	1744	1871	1998	2151
1.06	355	375	697	773	849	925	1014	1103	1205	1332	1459	1586	1713	1840	1967	2119
1.06	400	425	622	698	774	850	939	1028	1130	1257	1384	1511	1638	1765	1892	2045
1.06	425	450	583	659	735	811	900	989	1091	1218	1345	1472	1599	1726	1853	2005
1.06	450	475	543	619	696	772	861	950	1051	1178	1305	1432	1559	1686	1813	1966
1.07	375	400	661	737	814	890	979	1068	1169	1296	1423	1550	1677	1804	1931	2084
1.11	450	500	523	599	676	752	841	930	1032	1159	1286	1413	1540	1667	1794	1946
1.12	300	335	771	847	924	1000	1089	1178	1279	1406	1533	1660	1787	1914	2041	2194
1.12	335	375	712	788	865	941	1030	1119	1220	1347	1474	1601	1728	1855	1982	2135
1.12	425	475	563	639	715	791	880	969	1071	1198	1325	1452	1579	1706	1833	1985
1.12	500	560	-	-	589	665	754	843	945	1072	1199	1326	1453	1580	1707	1860
1.13	315	355	744	820	896	972	1061	1150	1252	1379	1506	1633	1760	1887	2014	2166
1.13	355	400	677	753	829	905	994	1083	1185	1312	1439	1566	1693	1820	1947	2099
1.13	400	450	602	678	754	831	920	1009	1110	1237	1364	1491	1618	1745	1872	2025
1.13	560	630	-	-	-	-	652	741	843	970	1097	1224	1351	1478	1605	1758
1.13	630	710	-	-	-	-	-	-	724	852	979	1106	1233	1360	1487	1640
1.13	710	800	-	-	-	-	-	-	-	-	845	972	1099	1226	1353	1506
1.14	375	425	641	717	794	870	959	1048	1149	1276	1403	1530	1657	1785	1912	2064
1.18	425	500	542	618	695	771	860	949	1051	1178	1305	1432	1559	1686	1813	1966
1.18	475	560	-	531	608	684	773	863	964	1091	1218	1345	1472	1600	1727	1879
1.19	300	355	755	831	908	984	1073	1162	1263	1390	1517	1644	1771	1898	2025	2178
1.19	315	375	727	804	880	956	1045	1134	1236	1363	1490	1617	1744	1871	1998	2150
1.19	400	475	582	658	734	810	899	989	1090	1217	1344	1471	1598	1725	1852	2005
1.20	335	400	692	768	845	921	1010	1099	1200	1327	1454	1581	1708	1835	1962	2115
1.20	355	425	656	733	809	885	974	1063	1165	1292	1419	1546	1673	1800	1927	2080
1.20	375	450	621	697	774	850	939	1028	1129	1256	1384	1511	1638	1765	1892	2044
1.25	300	375	739	815	892	968	1057	1146	1247	1374	1501	1628	1755	1882	2010	2162
1.25	400	500	561	637	714	790	879	968	1070	1197	1324	1451	1578	1705	1832	1985
1.25	450	560	-	550	627	703	792	882	983	1110	1238	1365	1492	1619	1746	1898
1.25	800	1000	-	-	-	-	-	-	-	-	-	-	-	994	1122	1275
1.26	500	630	-	-	-	608	697	786	888	1015	1143	1270	1397	1524	1651	1804
1.27	315	400	707	783	860	936	1025	1114	1216	1343	1470	1597	1724	1851	1978	2131
1.27	335	425	672	748	824	900	990	1079	1180	1307	1434	1561	1688	1816	1943	2095
1.27	355	450	636	712	789	865	954	1043	1145	1272	1399	1526	1653	1780	1907	2060
1.27	375	475	600	677	753	829	919	1008	1109	1236	1363	1491	1618	1745	1872	2024
1.27	560	710	-	-	-	-	-	675	777	904	1032	1159	1286	1414	1541	1693
1.27	630	800	-	-	-	-	-	-	-	777	905	1032	1160	1287	1414	1567
1.32	425	560	-	568	645	722	811	900	1002	1129	1257	1384	1511	1638	1765	1918
1.33	475	630	-	-	-	626	715	805	907	1034	1162	1289	1416	1543	1670	1823
1.34	300	400	718	795	871	947	1037	1126	1227	1354	1481	1608	1736	1863	1990	2142
1.34	355	475	615	692	768	844	934	1023	1125	1252	1379	1506	1633	1760	1887	2040
1.34	375	500	579	656	733	809	898	987	1089	1216	1343	1470	1598	1725	1852	2004
1.35	315	425	687	763	840	916	1005	1094	1196	1323	1450	1577	1704	1831	1958	2111
1.35	335	450	651	727	804	880	969	1058	1160	1287	1414	1541	1668	1796	1923	2075
1.40	450	630	-	-	567	644	734	823	925	1053	1180	1308	1435	1562	1689	1842
1.41	355	500	594	671	747	824	913	1002	1104	1231	1359	1486	1613	1740	1867	2020
1.41	400	560	510	587	664	740	830	919	1021	1148	1276	1403	1530	1657	1784	1937
1.41	710	1000	-	-	-	-	-	-	-	-	-	-	932	1060	1188	1342
1.42	300	425	698	774	851	927	1016	1105	1207	1334	1461	1588	1715	1843	1970	2122
1.42	335	475	630	706	783	859	949	1038	1140	1267	1394	1521	1648	1775	1903	2055
1.42	500	710	-	-	-	-	628	718	821	949	1077	1204	1332	1459	1586	1739
1.43	560	800	-	-	-	-	-	-	700	828	956	1084	1212	1339	1467	1620
1.44	315	450	666	742	819	895	984	1074	1175	1302	1430	1557	1684	1811	1938	2091

2
Design

8V

1.00 ~ 1.44

Color coding of Power rating correction factor : Kc

0.7	0.8	0.9	1.0	1.1	1.2
-----	-----	-----	-----	-----	-----

Center distance (mm)																Speed ratio
8V 2240	8V 2360	8V 2500	8V 2650	8V 2800	8V 3000	8V 3150	8V 3350	8V 3550	8V 3750	8V 4000	8V 4250	8V 4500	8V 4750	8V 5000	8V 5600	
2374	2526	2704	2894	3085	3339	3529	3783	4037	4291	4609	4926	5244	5561	5879	6641	1.00
2350	2502	2680	2871	3061	3315	3506	3760	4014	4268	4585	4903	5220	5538	5855	6617	1.00
2319	2471	2649	2839	3030	3284	3474	3728	3982	4236	4554	4871	5189	5506	5824	6586	1.00
2287	2439	2617	2808	2998	3252	3443	3697	3951	4205	4522	4840	5157	5475	5792	6554	1.00
2256	2408	2586	2776	2967	3221	3411	3665	3919	4173	4491	4808	5126	5443	5761	6523	1.00
2217	2369	2547	2737	2928	3182	3372	3626	3880	4134	4452	4769	5087	5404	5722	6484	1.00
2177	2329	2507	2698	2888	3142	3333	3587	3841	4095	4412	4730	5047	5365	5682	6444	1.00
2138	2290	2468	2659	2849	3103	3294	3548	3802	4056	4373	4691	5008	5326	5643	6405	1.00
2099	2251	2429	2619	2810	3064	3254	3508	3762	4016	4334	4651	4969	5286	5604	6366	1.00
2060	2212	2390	2580	2771	3025	3215	3469	3723	3977	4295	4612	4930	5247	5565	6327	1.00
1965	2117	2295	2486	2676	2930	3121	3375	3629	3883	4200	4518	4835	5153	5470	6232	1.00
1855	2007	2185	2376	2566	2820	3011	3265	3519	3773	4090	4408	4725	5043	5360	6122	1.00
1730	1882	2060	2250	2441	2695	2885	3139	3393	3647	3965	4282	4600	4917	5235	5997	1.00
1588	1740	1918	2109	2299	2553	2744	2998	3252	3506	3823	4141	4458	4776	5093	5855	1.00
2362	2514	2692	2882	3073	3327	3517	3771	4025	4279	4597	4914	5232	5549	5867	6629	1.05
2079	2231	2409	2600	2790	3044	3235	3489	3743	3997	4314	4632	4949	5267	5584	6346	1.05
2334	2486	2664	2855	3045	3299	3490	3744	3998	4252	4569	4887	5204	5522	5839	6601	1.06
2303	2455	2633	2824	3014	3268	3459	3713	3967	4221	4538	4856	5173	5491	5808	6570	1.06
2272	2424	2602	2792	2983	3237	3427	3681	3935	4189	4507	4824	5142	5459	5777	6539	1.06
2197	2349	2527	2718	2908	3162	3353	3607	3861	4115	4432	4750	5067	5385	5702	6464	1.06
2158	2310	2488	2678	2869	3123	3313	3567	3821	4075	4393	4710	5028	5345	5663	6425	1.06
2118	2270	2448	2639	2829	3083	3274	3528	3782	4036	4353	4671	4988	5306	5623	6385	1.06
2236	2388	2566	2757	2947	3201	3392	3646	3900	4154	4471	4789	5106	5424	5741	6503	1.07
2099	2251	2429	2619	2810	3064	3254	3508	3762	4016	4334	4651	4969	5286	5604	6366	1.11
2346	2498	2676	2867	3057	3311	3502	3756	4010	4264	4581	4899	5216	5534	5851	6613	1.12
2287	2439	2617	2808	2998	3252	3443	3697	3951	4205	4522	4840	5157	5475	5792	6554	1.12
2138	2290	2468	2659	2849	3103	3294	3548	3802	4056	4373	4691	5008	5326	5643	6405	1.12
2012	2164	2342	2533	2723	2977	3168	3422	3676	3930	4247	4565	4882	5200	5517	6279	1.12
2319	2471	2649	2839	3030	3284	3474	3728	3982	4236	4554	4871	5189	5506	5824	6586	1.13
2252	2404	2582	2772	2963	3217	3407	3661	3915	4169	4487	4804	5122	5439	5757	6519	1.13
2177	2329	2507	2698	2888	3142	3333	3587	3841	4095	4412	4730	5047	5365	5682	6444	1.13
1910	2062	2240	2431	2621	2875	3066	3320	3574	3828	4145	4463	4780	5098	5415	6177	1.13
1792	1944	2122	2313	2503	2757	2948	3202	3456	3710	4027	4345	4662	4980	5297	6059	1.13
1658	1810	1989	2179	2370	2624	2814	3068	3322	3576	3894	4211	4529	4846	5164	5926	1.13
2217	2369	2547	2737	2928	3182	3372	3626	3880	4134	4452	4769	5087	5404	5722	6484	1.14
2118	2270	2448	2639	2829	3083	3274	3528	3782	4036	4353	4671	4988	5306	5623	6385	1.18
2032	2184	2362	2552	2743	2997	3187	3441	3695	3949	4267	4584	4902	5219	5537	6299	1.18
2330	2482	2660	2851	3041	3295	3486	3740	3994	4248	4565	4883	5200	5518	5835	6598	1.19
2303	2455	2633	2823	3014	3268	3458	3712	3966	4220	4538	4855	5173	5490	5808	6570	1.19
2157	2309	2487	2678	2869	3123	3313	3567	3821	4075	4393	4710	5028	5345	5663	6425	1.19
2267	2420	2598	2788	2979	3233	3423	3677	3931	4185	4503	4820	5138	5455	5773	6535	1.20
2232	2384	2562	2753	2943	3197	3388	3642	3896	4150	4467	4785	5102	5420	5737	6499	1.20
2197	2349	2527	2717	2908	3162	3352	3606	3860	4114	4432	4749	5067	5384	5702	6464	1.20
2315	2467	2645	2835	3026	3280	3470	3724	3978	4232	4550	4867	5185	5502	5820	6582	1.25
2138	2290	2468	2658	2849	3103	3293	3547	3801	4055	4373	4690	5008	5325	5643	6405	1.25
2051	2203	2381	2572	2762	3016	3207	3461	3715	3969	4286	4604	4921	5239	5556	6319	1.25
1428	1580	1758	1949	2140	2394	2585	2839	3093	3347	3665	3983	4300	4618	4935	5697	1.25
1956	2108	2287	2477	2668	2922	3112	3366	3620	3874	4192	4510	4827	5145	5462	6224	1.26
2283	2435	2613	2804	2994	3248	3439	3693	3947	4201	4518	4836	5153	5471	5788	6550	1.27
2248	2400	2578	2768	2959	3213	3403	3657	3911	4165	4483	4800	5118	5435	5753	6515	1.27
2212	2364	2542	2733	2923	3177	3368	3622	3876	4130	4448	4765	5083	5400	5718	6480	1.27
2177	2329	2507	2697	2888	3142	3333	3587	3841	4095	4412	4730	5047	5365	5682	6444	1.27
1846	1998	2176	2367	2557	2812	3002	3256	3510	3764	4082	4399	4717	5034	5352	6114	1.27
1720	1872	2050	2241	2431	2686	2876	3130	3384	3638	3956	4274	4591	4909	5226	5988	1.27
2070	2222	2400	2591	2782	3036	3226	3480	3734	3988	4306	4623	4941	5258	5576	6338	1.32
1976	2128	2306	2496	2687	2941	3132	3386	3640	3894	4211	4529	4847	5164	5482	6244	1.33
2295	2447	2625	2815	3006	3260	3450	3704	3958	4212	4530	4847	5165	5482	5800	6562	1.34
2192	2344	2522	2713	2903	3158	3348	3602	3856	4110	4428	4745	5063	5380	5698	6460	1.34
2157	2309	2487	2678	2868	3122	3313	3567	3821	4075	4392	4710	5027	5345	5662	6424	1.34
2263	2415	2593	2784	2974	3228	3419	3673	3927	4181	4498	4816	5134	5451	5769	6531	1.35
2228	2380	2558	2748	2939	3193	3383	3638	3892	4146	4463	4781	5098	5416	5733	6495	1.35
1995	2147	2325	2516	2706	2960	3151	3405	3659	3913	4231	4548	4866	5183	5501	6263	1.40
2172	2324	2502	2693	2884	3138	3328	3582	3836	4090	4408	4725	5043	5360	5678	6440	1.41
2089	2242	2420	2610	2801	3055	3246	3500	3754	4008	4325	4643	4960	5278	5595	6358	1.41
1495	1648	1826	2017	2208	2463	2654	2908	3162	3416	3734	4052	4370	4687	5005	5767	1.41
2275	2427	2605	2795	2986	3240	3431	3685	3939	4193	4510	4828	5145	5463	5780	6542	1.42
2208	2360	2538	2728	2919	3173	3364	3618	3872	4126	4443	4761	5078	5396	5713	6475	1.42
1892	2044	2222	2413	2604	2858	3048	3302	3557	3811	4128	4446	4764	5081	5399	6161	1.42
1773	1925	2103	2294	2485	2739	2930	3184	3438	3692	4010	4328	4645	4963	5280	6043	1.43
2243	2395	2573	2764	2954	3208	3399	3653	3907	4161	4479	4796	5114	5431	5749	6511	1.44

2

Design



● 8V (SR = 1.49 ~ 4.02)

Table 2-43-2 Drive Selection Table

Speed ratio	Effective diameter (mm)		Center distance (mm)													
	Small pulley	Large pulley	8V	8V	8V	8V	8V	8V	8V	8V	8V	8V	8V	8V	8V	8V
			1000	1060	1120	1180	1250	1320	1400	1500	1600	1700	1800	1900	2000	2120
1.49	425	630	-	-	585	662	752	842	944	1072	1199	1326	1454	1581	1708	1861
1.50	335	500	609	685	762	839	928	1017	1119	1246	1374	1501	1628	1755	1882	2035
1.50	375	560	528	605	682	759	848	938	1040	1167	1294	1422	1549	1676	1803	1956
1.50	475	710	-	-	-	-	646	736	839	967	1095	1223	1350	1478	1605	1758
1.51	300	450	677	753	830	906	996	1085	1187	1314	1441	1568	1695	1822	1950	2102
1.52	315	475	645	721	798	874	964	1053	1155	1282	1409	1536	1664	1791	1918	2070
1.57	800	1250	-	-	-	-	-	-	-	-	-	-	-	-	-	1059
1.58	400	630	-	-	603	680	770	860	962	1090	1218	1345	1473	1600	1727	1880
1.58	450	710	-	-	-	-	664	754	857	985	1113	1241	1369	1496	1624	1777
1.59	300	475	655	732	809	885	975	1064	1166	1293	1421	1548	1675	1802	1929	2082
1.59	355	560	542	619	696	773	863	952	1054	1182	1309	1437	1564	1691	1818	1971
1.59	630	1000	-	-	-	-	-	-	-	-	-	859	988	1117	1246	1400
1.60	315	500	623	700	777	853	943	1032	1134	1262	1389	1516	1643	1770	1898	2050
1.61	500	800	-	-	-	-	-	-	742	871	1000	1128	1256	1384	1512	1665
1.68	300	500	634	711	788	864	954	1043	1145	1273	1400	1527	1655	1782	1909	2062
1.68	335	560	556	633	711	788	877	967	1069	1197	1324	1452	1579	1706	1834	1986
1.68	425	710	-	-	-	590	681	772	875	1003	1132	1260	1387	1515	1642	1795
1.69	375	630	-	542	620	698	788	878	980	1108	1236	1364	1491	1619	1746	1899
1.69	475	800	-	-	-	-	-	655	759	889	1018	1146	1274	1402	1530	1683
1.77	710	1250	-	-	-	-	-	-	-	-	-	-	-	-	-	1121
1.78	400	710	-	-	-	607	699	789	893	1021	1150	1278	1406	1533	1661	1814
1.79	315	560	570	647	725	802	892	982	1084	1212	1339	1467	1594	1721	1849	2002
1.79	355	630	-	555	634	712	802	892	995	1123	1251	1379	1506	1634	1761	1914
1.79	450	800	-	-	-	-	-	672	777	906	1035	1164	1292	1420	1548	1702
1.79	560	1000	-	-	-	-	-	-	-	-	-	907	1037	1167	1296	1451
1.88	300	560	580	658	736	813	903	993	1095	1223	1350	1478	1605	1733	1860	2013
1.89	335	630	-	569	648	726	816	907	1009	1138	1265	1393	1521	1648	1776	1929
1.89	425	800	-	-	-	-	-	689	794	924	1053	1182	1310	1439	1567	1720
1.91	375	710	-	-	-	624	716	807	910	1039	1168	1296	1424	1552	1679	1833
1.99	630	1250	-	-	-	-	-	-	-	-	-	-	-	-	1016	1175
2.01	355	710	-	-	558	637	729	821	925	1054	1182	1311	1439	1566	1694	1848
2.01	400	800	-	-	-	-	612	706	811	941	1071	1200	1328	1457	1585	1739
2.01	500	1000	-	-	-	-	-	-	-	-	816	948	1079	1209	1339	1493
2.01	800	1600	-	-	-	-	-	-	-	-	-	-	-	-	-	-
2.02	315	630	503	583	662	740	830	921	1024	1152	1280	1408	1536	1663	1791	1944
2.12	300	630	513	593	672	750	841	931	1034	1163	1291	1419	1547	1674	1802	1955
2.12	475	1000	-	-	-	-	-	-	-	-	832	965	1096	1226	1356	1511
2.14	335	710	-	-	571	651	743	835	939	1068	1197	1325	1453	1581	1709	1862
2.15	375	800	-	-	-	-	629	722	828	959	1088	1218	1346	1475	1603	1757
2.24	450	1000	-	-	-	-	-	-	-	-	849	982	1113	1244	1374	1529
2.24	560	1250	-	-	-	-	-	-	-	-	-	-	-	927	1062	1222
2.26	710	1600	-	-	-	-	-	-	-	-	-	-	-	-	-	-
2.27	315	710	-	-	584	664	757	848	952	1082	1211	1339	1468	1596	1724	1877
2.27	355	800	-	-	-	-	642	736	841	972	1102	1232	1361	1489	1618	1771
2.37	425	1000	-	-	-	-	-	-	-	729	865	998	1130	1261	1391	1547
2.39	300	710	-	-	594	674	767	859	963	1093	1222	1350	1479	1607	1735	1888
2.41	335	800	-	-	-	-	655	749	855	986	1116	1246	1375	1504	1632	1786
2.52	400	1000	-	-	-	-	-	-	-	745	881	1015	1147	1278	1408	1564
2.52	500	1250	-	-	-	-	-	-	-	-	-	-	-	966	1102	1262
2.55	630	1600	-	-	-	-	-	-	-	-	-	-	-	-	-	-
2.56	315	800	-	-	-	571	668	762	868	1000	1130	1260	1389	1518	1646	1800
2.65	475	1250	-	-	-	-	-	-	-	-	-	-	-	982	1118	1279
2.69	300	800	-	-	-	581	677	772	878	1010	1141	1270	1400	1529	1657	1811
2.69	375	1000	-	-	-	-	-	-	-	761	898	1032	1164	1295	1426	1582
2.80	450	1250	-	-	-	-	-	-	-	-	-	-	-	998	1134	1296
2.84	355	1000	-	-	-	-	-	-	-	774	911	1045	1178	1309	1440	1596
2.87	560	1600	-	-	-	-	-	-	-	-	-	-	-	-	-	-
2.96	425	1250	-	-	-	-	-	-	-	-	-	-	873	1014	1151	1312
3.02	335	1000	-	-	-	-	-	-	-	786	924	1058	1191	1323	1453	1610
3.15	400	1250	-	-	-	-	-	-	-	-	-	-	888	1029	1167	1329
3.21	315	1000	-	-	-	-	-	-	-	799	937	1071	1205	1336	1467	1624
3.22	500	1600	-	-	-	-	-	-	-	-	-	-	-	-	-	-
3.36	375	1250	-	-	-	-	-	-	-	-	-	-	904	1045	1183	1345
3.37	300	1000	-	-	-	-	-	-	665	808	946	1081	1215	1346	1478	1634
3.39	475	1600	-	-	-	-	-	-	-	-	-	-	-	-	-	-
3.56	355	1250	-	-	-	-	-	-	-	-	-	-	916	1058	1196	1358
3.58	450	1600	-	-	-	-	-	-	-	-	-	-	-	-	-	-
3.77	335	1250	-	-	-	-	-	-	-	-	-	-	928	1070	1209	1371
3.80	425	1600	-	-	-	-	-	-	-	-	-	-	-	-	-	-
4.02	315	1250	-	-	-	-	-	-	-	-	-	-	941	1083	1221	1384

2

Design

8V

1.49 ~ 4.02

Color coding of Power rating correction factor : Kc

0.7	0.8	0.9	1.0	1.1	1.2
-----	-----	-----	-----	-----	-----

Center distance (mm)																Speed ratio
8V 2240	8V 2360	8V 2500	8V 2650	8V 2800	8V 3000	8V 3150	8V 3350	8V 3550	8V 3750	8V 4000	8V 4250	8V 4500	8V 4750	8V 5000	8V 5600	
2014	2166	2344	2535	2725	2980	3170	3424	3678	3933	4250	4568	4885	5203	5520	6283	1.49
2188	2340	2518	2708	2899	3153	3344	3598	3852	4106	4423	4741	5059	5376	5694	6456	1.50
2109	2261	2439	2630	2820	3074	3265	3519	3773	4027	4345	4662	4980	5297	5615	6377	1.50
1911	2063	2241	2432	2623	2877	3068	3322	3576	3830	4148	4465	4783	5100	5418	6180	1.50
2255	2407	2585	2775	2966	3220	3411	3665	3919	4173	4490	4808	5125	5443	5760	6523	1.51
2223	2375	2553	2744	2934	3189	3379	3633	3887	4141	4459	4776	5094	5411	5729	6491	1.52
1214	1368	1549	1741	1933	2188	2380	2635	2890	3144	3463	3781	4099	4417	4735	5497	1.57
2033	2185	2363	2554	2745	2999	3189	3444	3698	3952	4269	4587	4905	5222	5540	6302	1.58
1930	2082	2260	2451	2642	2896	3087	3341	3595	3849	4167	4485	4802	5120	5437	6200	1.58
2235	2387	2565	2755	2946	3200	3391	3645	3899	4153	4470	4788	5106	5423	5741	6503	1.59
2124	2276	2454	2645	2836	3090	3280	3534	3788	4043	4360	4678	4995	5313	5630	6393	1.59
1554	1707	1886	2077	2268	2523	2714	2969	3223	3477	3795	4113	4431	4749	5066	5829	1.59
2203	2355	2533	2724	2914	3169	3359	3613	3867	4121	4439	4757	5074	5392	5709	6471	1.60
1818	1970	2149	2340	2531	2785	2976	3230	3484	3738	4056	4374	4692	5009	5327	6089	1.61
2214	2367	2545	2735	2926	3180	3371	3625	3879	4133	4451	4768	5086	5403	5721	6483	1.68
2139	2291	2470	2660	2851	3105	3296	3550	3804	4058	4376	4693	5011	5328	5646	6408	1.68
1948	2101	2279	2470	2661	2915	3106	3360	3614	3868	4186	4504	4821	5139	5457	6219	1.68
2052	2204	2382	2573	2764	3018	3209	3463	3717	3971	4289	4606	4924	5242	5559	6321	1.69
1836	1989	2168	2359	2549	2804	2995	3249	3503	3758	4075	4393	4711	5028	5346	6108	1.69
1277	1432	1613	1806	1998	2254	2446	2702	2957	3212	3530	3849	4167	4485	4803	5566	1.77
1967	2120	2298	2489	2680	2934	3125	3379	3633	3888	4205	4523	4841	5158	5476	6238	1.78
2154	2307	2485	2675	2866	3120	3311	3565	3819	4073	4391	4709	5026	5344	5661	6424	1.79
2067	2219	2397	2588	2779	3033	3224	3478	3732	3987	4304	4622	4939	5257	5575	6337	1.79
1855	2008	2186	2377	2568	2823	3014	3268	3522	3777	4095	4412	4730	5048	5365	6128	1.79
1605	1758	1937	2129	2320	2575	2767	3021	3276	3530	3848	4166	4484	4802	5120	5883	1.79
2166	2318	2496	2687	2878	3132	3323	3577	3831	4085	4403	4720	5038	5355	5673	6435	1.88
2082	2234	2413	2603	2794	3049	3239	3493	3748	4002	4320	4637	4955	5273	5590	6352	1.89
1874	2026	2205	2396	2587	2842	3033	3287	3541	3796	4114	4431	4749	5067	5385	6147	1.89
1986	2138	2317	2508	2699	2953	3144	3398	3653	3907	4225	4542	4860	5178	5495	6258	1.91
1332	1488	1670	1863	2056	2313	2505	2761	3016	3271	3590	3909	4227	4545	4864	5627	1.99
2001	2153	2332	2523	2714	2968	3159	3413	3668	3922	4240	4558	4875	5193	5511	6273	2.01
1892	2045	2224	2415	2606	2861	3051	3306	3560	3815	4133	4451	4768	5086	5404	6166	2.01
1648	1802	1981	2173	2365	2620	2811	3066	3321	3576	3894	4212	4530	4848	5166	5929	2.01
-	-	1225	1424	1622	1883	2077	2335	2593	2849	3170	3490	3809	4128	4447	5212	2.01
2097	2249	2428	2619	2809	3064	3254	3509	3763	4017	4335	4653	4970	5288	5606	6368	2.02
2108	2261	2439	2630	2821	3075	3266	3520	3774	4029	4346	4664	4982	5300	5617	6379	2.12
1666	1820	1999	2191	2383	2638	2830	3085	3340	3594	3913	4231	4549	4867	5185	5948	2.12
2016	2168	2347	2538	2729	2983	3174	3429	3683	3937	4255	4573	4891	5208	5526	6288	2.14
1910	2063	2242	2433	2625	2879	3070	3325	3579	3834	4152	4470	4787	5105	5423	6186	2.15
1684	1838	2017	2210	2401	2657	2848	3103	3358	3613	3932	4250	4568	4886	5204	5967	2.24
1380	1537	1719	1913	2106	2363	2556	2812	3068	3323	3642	3961	4280	4598	4916	5680	2.24
-	-	1284	1485	1683	1945	2140	2399	2657	2914	3235	3555	3875	4195	4514	5279	2.26
2030	2183	2362	2553	2744	2998	3189	3444	3698	3953	4270	4588	4906	5224	5541	6304	2.27
1925	2078	2257	2448	2639	2894	3085	3340	3594	3849	4167	4485	4803	5121	5438	6201	2.27
1702	1856	2036	2228	2420	2675	2867	3122	3377	3632	3950	4269	4587	4905	5223	5986	2.37
2041	2194	2373	2564	2755	3010	3201	3455	3710	3964	4282	4600	4917	5235	5553	6315	2.39
1940	2093	2272	2463	2654	2909	3100	3355	3610	3864	4182	4500	4818	5136	5454	6216	2.41
1719	1873	2054	2246	2438	2694	2885	3141	3396	3651	3969	4287	4606	4924	5242	6005	2.52
1421	1578	1761	1955	2149	2406	2599	2855	3111	3367	3686	4005	4324	4643	4961	5725	2.52
-	1143	1335	1538	1737	2000	2195	2455	2714	2971	3293	3614	3934	4253	4573	5339	2.55
1954	2107	2286	2478	2669	2924	3115	3370	3625	3879	4197	4515	4833	5151	5469	6232	2.56
1438	1595	1778	1973	2167	2424	2617	2874	3130	3386	3705	4024	4343	4662	4980	5744	2.65
1965	2118	2297	2489	2680	2935	3127	3381	3636	3891	4209	4527	4845	5163	5480	6243	2.69
1737	1891	2072	2264	2456	2712	2904	3159	3414	3669	3988	4306	4625	4943	5261	6024	2.69
1455	1612	1795	1990	2184	2442	2635	2892	3148	3404	3723	4043	4361	4680	4999	5763	2.80
1751	1905	2086	2278	2471	2727	2918	3174	3429	3684	4003	4321	4640	4958	5276	6039	2.84
-	1187	1381	1584	1784	2048	2244	2504	2763	3021	3343	3664	3985	4305	4624	5390	2.87
1472	1629	1813	2008	2202	2460	2653	2910	3166	3422	3742	4061	4380	4699	5018	5782	2.96
1765	1920	2100	2293	2485	2741	2933	3189	3444	3699	4018	4336	4655	4973	5291	6054	3.02
1488	1646	1830	2025	2219	2478	2671	2928	3184	3440	3760	4079	4399	4717	5036	5801	3.15
1779	1934	2114	2307	2500	2756	2948	3203	3459	3714	4033	4351	4670	4988	5306	6070	3.21
-	1224	1419	1623	1824	2088	2285	2546	2805	3064	3386	3707	4028	4348	4668	5435	3.22
1505	1663	1847	2042	2237	2495	2689	2946	3202	3459	3778	4098	4417	4736	5055	5819	3.36
1790	1944	2125	2318	2511	2767	2959	3214	3470	3725	4044	4362	4681	4999	5317	6081	3.37
1067	1240	1435	1639	1840	2105	2302	2563	2823	3081	3404	3725	4046	4367	4687	5453	3.39
1518	1677	1861	2056	2251	2510	2703	2960	3217	3473	3793	4113	4432	4751	5070	5834	3.56
1082	1255	1451	1656	1857	2122	2319	2580	2840	3099	3422	3743	4064	4385	4705	5472	3.58
1532	1690	1874	2070	2265	2524	2717	2974	3231	3488	3808	4127	4447	4766	5085	5849	3.77
1097	1271	1467	1672	1873	2139	2336	2598	2858	3117	3439	3761	4082	4403	4723	5490	3.80
1545	1704	1888	2084	2279	2538	2731	2989	3246	3502	3822	4142	4461	4780	5099	5864	4.02



● 8V (SR = 4.04 ~ 5.41)

Table 2-43-3 Drive Selection Table

Speed ratio	Effective diameter (mm)		Center distance (mm)													
			8V	8V	8V	8V	8V	8V	8V	8V	8V	8V	8V	8V	8V	8V
	Small pulley	Large pulley	1000	1060	1120	1180	1250	1320	1400	1500	1600	1700	1800	1900	2000	2120
4.04	400	1600	-	-	-	-	-	-	-	-	-	-	-	-	-	-
4.22	300	1250	-	-	-	-	-	-	-	-	-	801	950	1092	1231	1394
4.31	375	1600	-	-	-	-	-	-	-	-	-	-	-	-	-	-
4.56	355	1600	-	-	-	-	-	-	-	-	-	-	-	-	-	-
4.83	335	1600	-	-	-	-	-	-	-	-	-	-	-	-	-	-
5.15	315	1600	-	-	-	-	-	-	-	-	-	-	-	-	-	977
5.41	300	1600	-	-	-	-	-	-	-	-	-	-	-	-	-	986



8V

4.04 ~ 5.41

Color coding of Power rating correction factor : Kc

0.7	0.8	0.9	1.0	1.1	1.2
-----	-----	-----	-----	-----	-----

Center distance (mm)																Speed ratio
8V 2240	8V 2360	8V 2500	8V 2650	8V 2800	8V 3000	8V 3150	8V 3350	8V 3550	8V 3750	8V 4000	8V 4250	8V 4500	8V 4750	8V 5000	8V 5600	
1112	1286	1483	1688	1890	2156	2353	2615	2875	3134	3457	3779	4100	4421	4741	5509	4.04
1555	1714	1898	2094	2289	2548	2742	3000	3256	3513	3833	4153	4472	4792	5111	5875	4.22
1127	1302	1499	1704	1906	2172	2370	2632	2892	3152	3475	3797	4118	4439	4759	5527	4.31
1140	1314	1511	1717	1920	2186	2384	2646	2906	3166	3489	3811	4133	4454	4774	5542	4.56
1152	1326	1524	1730	1933	2199	2397	2660	2920	3180	3503	3825	4147	4468	4788	5556	4.83
1164	1339	1537	1743	1946	2213	2411	2673	2934	3194	3517	3840	4161	4482	4803	5571	5.15
1173	1348	1546	1753	1956	2223	2421	2684	2944	3204	3528	3850	4172	4493	4814	5582	5.41



Reference



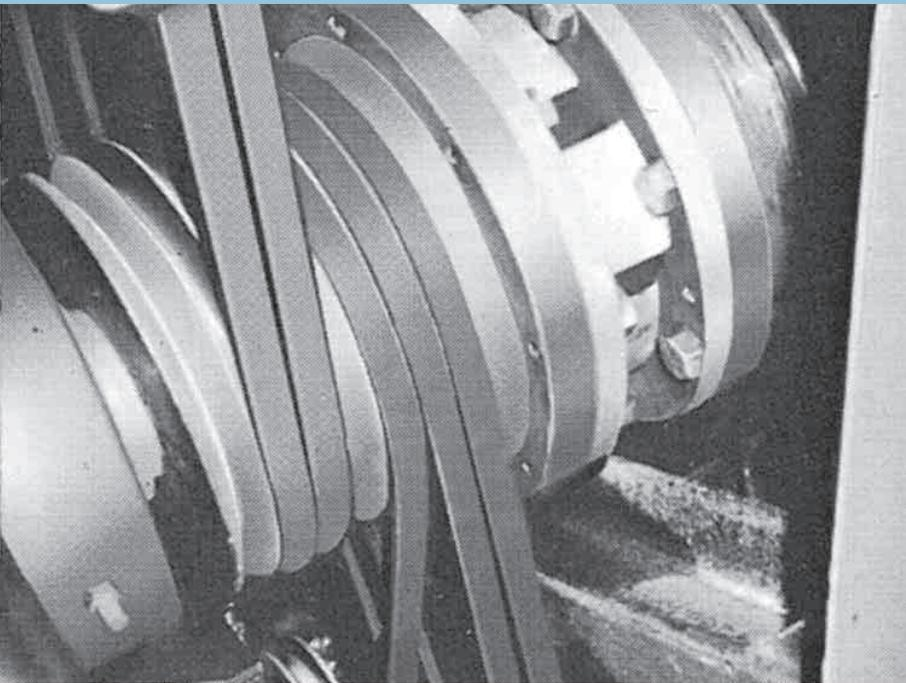

3. Reference

Length measurement

Tensioning

Use of idlers

Quarter-Turn Drives

V-Flat pulley drives

Multi V-Belts

Storage and Handling of V-Belts

Request for belt design

Global Factories & Sales Offices

Length measurement

Precise measuring methods are specified in JIS K 6323 for Classical V-Belts, RMA IP-22 for Maxstar Wedge V-Belts, and DIN 7753 Part 1 for Narrow V-Belts. The V-Belt is laid over two equal size pulleys as following figure. These pulley grooves are designed to correspond with the belt section specified in Table 3-2 ~ 3-4. The measuring force is added to the measuring pulley in such a way. Belt length is calculated by the formula which is specified in Table 3-1.

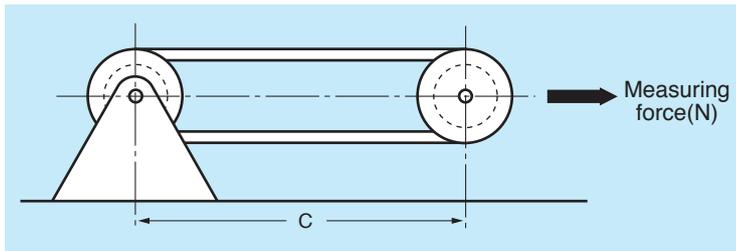

Fig. 3-1 Diagram of fixture for length measurement

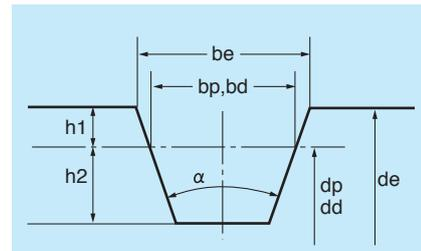

Fig. 3-2 Measuring pulley

Length calculation formula

Table 3-1

Belt section	Length designation	Length calculation formula
M	Effective length : L_e	$L_e = 2C + \pi d_e$
A, B, C, D, E AX, BX, CX	Pitch length : L_p	$L_p = 2C + \pi d_p$
3V, 5V, 8V 3VX, 5VX	Effective length : L_e	$L_e = 2C + \pi d_e$
SPZ, SPA, SPB, SPC SPZX, SPAX, SPBX, SPCX	Datum length : L_d	$L_d = 2C + \pi d_d$

Pulley dimensions and measuring force of Classical V-Belts for JIS

Table 3-2

Belt section		M	A AX	B BX	C CX	D	E
Pitch width : bp	mm	8.0	9.2	12.5	16.9	24.6	28.7
Effective width : be	mm	9.65	11.95	15.86	21.18	30.78	36.96
Pitch diameter : dp	mm	-	95.49	127.32	222.82	381.97	572.96
Effective diameter : de	mm	63.66	104.49	138.32	236.82	400.97	598.36
Pulley pitch circumference : πdp	mm	-	300	400	700	1200	1800
Pulley effective circumference : πde	mm	200	-	-	-	-	-
Angle : α	°	34	34	34	34	36	36
Distance down to pitch line : h1	mm	2.7	4.5	5.5	7.0	9.5	12.7
Measuring force	N	98	196	294	736	1373	1765

Pulley dimensions and measuring force of Maxstar Wedge V-Belts for RMA/MPTA

Table 3-3

Belt section		3V 3VX	5V 5VX	8V
Effective width : be	mm	8.9	15.2	25.4
Effective diameter : de	mm	95.5	191.0	318.3
Pulley effective circumference : πde	mm	300	600	1000
Angle : α	°	38	38	38
Measuring force	N	445	1000	2225

Pulley dimensions and measuring force of Narrow V-Belts for DIN

Table 3-4

Belt section		SPZ SPZX	SPA SPAX	SPB SPBX	SPC SPCX
Datum width : bd	mm	8.5	11.0	14.0	19.0
Datum diameter : dd	mm	95.49	143.24	190.99	318.31
Effective diameter : de	mm	100	149	198	328
Pulley datum circumference : πdd	mm	300	450	600	1000
Angle : α	°	36	36	36	36
Distance down to datum line : h1	mm	2.255	2.880	3.505	4.845
Measuring force	N	360	560	900	1500



■ Tensioning design V-Belts

Tension of the belts on a V-Belt drive is usually not critical. A few simple rules about tensioning will satisfy most of your requirements. For your proper tensioning of V-Belts, just follow these four steps.

Step 1.

After placing V-Belts into the pulleys grooves, increase the distance between pulleys until V-Belts are snug.

Step 2.

Measure the length of the span for your drive. At the center of the span, apply Deflection load ($F\delta$) in Fig. 3-3 on page 3-7 with spring scale in a direction perpendicular to the span until the belt is deflected from the normal by amount equal to 1.6mm for every 100mm.

Step 3.

A few days are necessary for V-Belts to seat into pulley grooves. The belt tension for a V-Belt drive is the lowest at which the belts will not slip under the highest load condition. A bigger tension than force maximum will reduce the life of belts and bearings, and a less tension than force minimum, will cause slip.

Step 4.

During the normal operation, V-Belts will seat itself into pulley grooves, and will require periodic checks to maintain tension. The seating occurs more rapidly during the first 20-24 hours of operation. It is necessary to keep the belts and pulleys from any foreign materials which may cause slip. If V-Belts slip, tighten them. Recommendable belt Deflection load to get the proper tension is shown in table 3-6. But the ideal tension can be obtained as follows :

1. Calculate Span length

$$L_s = \sqrt{C^2 - \frac{(D_d - d_d)^2}{4}}$$

L_s : Span length (mm)
 C : Center distance (mm)
 D_d : Large pulley datum diameter (mm)
 d_d : Small pulley datum diameter (mm)

2. Calculate Minimum static tension

$$T_o = \left\{ 500 \cdot \frac{(2.5 - K_\theta)}{K_\theta} \cdot \frac{P_d}{n_b \cdot V + WV^2} \right\} \times 0.9$$

T_o : Minimum static tension (N / pc.) n_b : Number of belts
 K_θ : Arc of contact correction factor W : Belt weight per unit (kg / m) → see Table 3-5 in page 3-6
 P_d : Design power (kW) V : Belt speed (m/sec.)

$T_{o\max}(\text{initial})$: Maximum belt tension at initial fitting (N/a belt)
 $T_{o\max}(\text{retension})$: Maximum belt tension at retensioning (N/a belt)
 $T_{o\max}(\text{initial}) = 1.5 \cdot T_o$
 $T_{o\max}(\text{retension}) = 1.3 \cdot T_o$

3. Calculate Deflection load

A) Multiple V-Belts drivers :

$$F\delta_{\min} = \frac{T_o + Y}{16} \quad F\delta_{\max}(\text{initial}) = \frac{1.5 \cdot T_o + Y}{16} \quad F\delta : \text{Deflection load (N / a belt)}$$

$$F\delta_{\max}(\text{retension}) = \frac{1.3 \cdot T_o + Y}{16} \quad Y : \text{a constant} \rightarrow \text{see Table 3-5 in page 3-6}$$

L : Belt length (mm)
 L_s : Span length (mm)

B) Single V-Belts drivers :

$$F\delta_{\min} = \frac{T_o + Y(L_s/L)}{16} \quad F\delta_{\max}(\text{initial}) = \frac{1.5 \cdot T_o + Y(L_s/L)}{16}$$

$$F\delta_{\max}(\text{retension}) = \frac{1.3 \cdot T_o + Y(L_s/L)}{16}$$

4. Calculate maximum Shaft load at initial fitting

$$F_s = 2n_b \times T_o \times \sin \frac{\theta}{2} \times 1.5$$

F_s : Static shaft load (N)
 θ : Arc of contact for small pulley



Belt weight per unit (W) & Constant (Y)

Table 3-5

Belt Section	W(kg/m)	Y(N/pc)
M	0.05	9.8
A	0.12	14.7
B	0.20	19.6
C	0.30	29.4
D	0.65	58.8
E	1.00	108.0
SPZ	0.08	19.6
SPA	0.13	26.1
SPB	0.21	39.2
SPC	0.37	71.3
3V	0.08	19.6
5V	0.23	39.2
8V	0.60	98.1
ZX	0.06	9.8
AX	0.11	14.7
BX	0.18	19.6
CX	0.33	29.4
SPZX	0.08	19.6
SPAX	0.11	26.1
SPBX	0.21	39.2
SPCX	0.36	71.3
3VX	0.07	19.6
5VX	0.20	39.2



■ Tensioning of V-Belts

Step 1. Calculate Span length

Span length means the length between the belt contact points to the pulleys (L_s in Fig. 3-3).

If the diameter of the drive pulley and the driven pulley are the same, it is the same with Center Distance.

Fig. 3-3 Deflection measurement

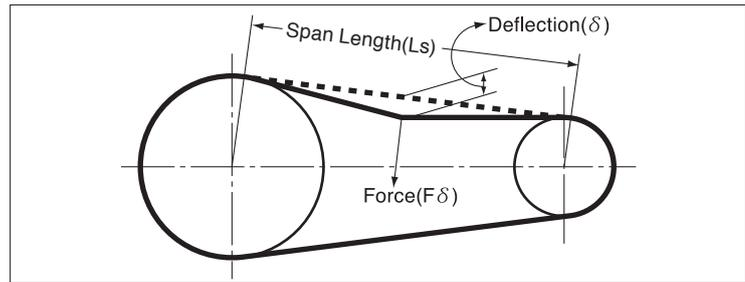

Step 2. Calculate Deflection load by loading on the center of Span length.

Load on the center of Span length at right angle to the belt with the equipment like a spring balance, then check the load.

Deflection should be 1.6mm per 100mm of Span length. For example, if Span length is 500mm, Deflection should be 8mm.

Step 3. Adjust the belt tension so that the load calculated by step 2. is between maximum and minimum Deflection load in Table 3-6.

Deflection load & Belt tension

Table 3-6

Belt section	Small pulley diameter (mm)	Minimum tensioning conditions		Maximum tensioning conditions			
		Deflection load (N)	Belt tension (N)	Initial fitting		Retension	
				Deflection load (N)	Belt tension (N)	Deflection load (N)	Belt tension (N)
M	~50	6	80	8	120	7	110
	51~70	7	110	11	160	9	140
	71~100	8	120	12	180	11	160
13/A	~80	12	170	17	250	15	220
	81~100	15	220	22	330	19	290
	101~132	18	270	27	410	23	350
17/B	~125	19	290	29	440	25	380
	126~160	25	380	36	560	32	490
	161~200	28	430	41	640	36	560
22/C	~200	36	540	52	800	46	700
	201~250	42	650	62	970	54	840
	251~355	50	770	74	1160	64	1000
32/D	~355	72	1090	106	1640	92	1420
	356~560	94	1450	139	2170	121	1880
	561~800	109	1690	162	2530	141	2190
40/E	~560	107	1600	157	2400	137	2080
	561~800	134	2030	197	3050	172	2640
	801~950	148	2260	219	3390	191	2940
SPZ/3V	~70	12	180	17	260	16	230
	71~90	15	220	22	340	19	290
	91~125	19	280	27	420	24	360
SPA	~100	20	290	29	430	25	370
	101~140	27	400	39	600	34	520
	141~200	32	480	47	720	40	620
SPB/5V	~160	36	530	52	800	46	690
	161~224	46	690	67	1030	58	890
	225~355	53	810	79	1220	69	1060
SPC	~250	66	990	98	1490	85	1290
	251~355	84	1280	124	1910	108	1660
	356~560	99	1510	146	2270	128	1970
8V	~355	104	1570	154	2360	134	2040
	356~560	136	2080	201	3120	175	2700
	561~800	154	2360	227	3540	198	3070
10/ZX	~50	7	110	11	170	10	150
	51~70	9	130	12	190	11	170
	71~100	9	140	14	210	12	180
13/AX	~80	17	250	24	370	21	320
	81~100	18	280	27	420	23	360
	101~132	20	310	30	460	26	400
17/BX	~125	27	410	40	620	35	540
	126~160	29	440	42	660	37	570
	161~200	30	460	44	690	39	600
22/CX	~200	46	710	69	1070	60	930
	201~250	48	740	71	1110	62	960
	251~355	50	770	74	1160	64	1000
SPZX/3VX	~70	17	260	26	390	22	340
	71~90	20	300	29	450	26	390
	91~125	22	340	33	510	29	440
SPAX	~100	27	400	39	600	34	520
	101~140	33	500	49	750	42	650
	141~200	37	570	55	860	48	740
SPBX/5VX	~160	46	690	67	1040	59	900
	161~224	55	840	81	1250	71	1090
	225~355	63	970	93	1450	81	1260
SPCX	~250	79	1200	117	1800	102	1560
	251~355	91	1380	134	2070	116	1790
	356~560	101	1550	150	2330	131	2020



■ Use of idlers

Idlers shorten the belt life. Use idlers only in the following cases.

- When the center distance cannot be adjusted.
- When the V-Belt is used as a clutch.
- When the belt span is too long and the belt vibrates.
- When a longer arc of contact with pulleys is required.
- When the belt tension is to be maintained during operation.
- When the belt is required to avoid obstructions.

Use of inside idlers

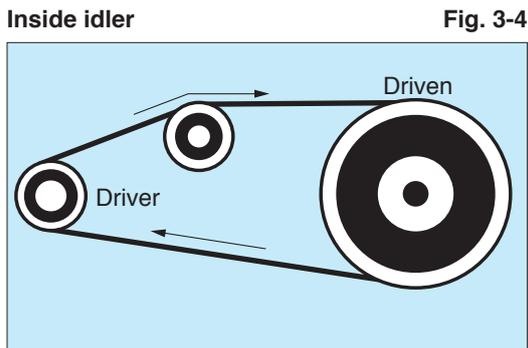

Place a grooved idler on the slack side of the belt. It is preferable to use an idler on the inside of the layout, not the outside.

The inside idler should be placed near the large pulley, otherwise the arc of contact becomes smaller and belt might slip.

Use of backside idlers

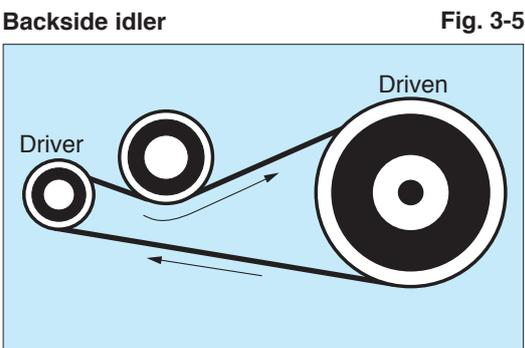

The backside idlers shorten the belt life significantly, and are not recommended.

Use a flat pulley as a backside idler and place it near the small pulley.

The diameter of idler pulleys shall be larger than the diameter specified in Table 3-7.

Use the idler bigger than twice the size of the small pulley for Maxstar Wedge.

Minimum pitch diameter of idler pulley **Table 3-7**

Section	Inside idler(mm)	Backside idler(mm)
A	75	110
B	125	190
C	225	340
D	325	490
E	525	790



Quarter-Turn Drives

Quarter-Turn Drives are drives where the driver and driven shafts are at right angles to each other. To design Quarter-Turn Drives, follow the steps given in "Calculation of V-Belt drives design" section for designing an ordinary drive, keeping in mind the following special points:

1. Speed ratio should be 2.50 or less.
2. A standard V-Belt length should be chosen which will give a minimum Center distance of:

$$\text{Minimum } C = 5.5(D+W)(\text{mm})$$

D = Large pulley outside diameter (mm)

W = Width of Deep Grooved Pulley, from Table 3-9

3. Aligning the drive

Looking down on the drive, a line from the center of the vertical shaft should pass through the center of the face of the pulley on the horizontal shaft. The horizontal shaft should be at right angles to this line. See "Top View" in Fig. 3-6.

Looking at the side of the drive, the center of the horizontal shaft should be raised a distance "Y", from Table 3-8 above the level line through the center of the face of the pulley on the vertical shaft. See "Side View" in Fig. 3-6.

4. Direction of rotation

The direction of rotation must be such that the Tight side of the drive will be on the bottom. See "Side View" in Fig. 3-6.

5. Power rating for Quarter-Turn Drives should be 90% from it for ordinary drives. And Arc of contact correction factor ($K\theta$) may be taken as 1.00 on Quarter-Turn Drives.

6. Deep grooved pulleys should always be used on Quarter-Turn Drives using individual V-Belts.

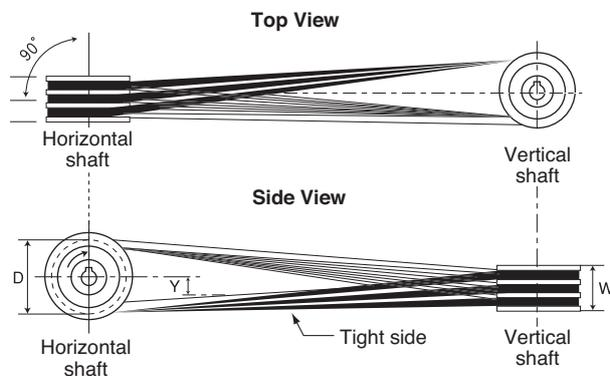

Fig. 3-6

Table 3-8 (unit: mm)

Center distance	Dimension Y
1500	65
2000	70
2500	75
3000	100
3500	130
4000	165
4500	195
5000	230
5500	270
6000	305

Width of Deep grooved pulley (W)

Table 3-9 (unit: mm)

No. of Grooves	V-Belt Section							
	A	B	C	D	E	3V	5V	8V
1	24	29	41	54	68	19	29	43
2	42	51	73	98	120.5	32	49	76
3	60	73	105	143	173	44	70	110
4	78	95	136	187	225.5	57	90	143
5	96	117	168	232	278	70	111	176
6	114	140	200	276	330.5	83	132	209
7	132	162	232	321	383	95	152	243
8	150	184	263	365	435.5	108	173	276
9	168	206	295	410	488	121	194	309
10	186	229	327	454	540.5	133	214	343

■ V-Flat pulley drives

What V-Flat drive is to use a V-Grooved pulley and the other flat pulley with regard to V-Belt drive.

This type of drive is used when it is desirable to change a flat belt drive into a V-Belt drive, because it is often most economical to retain the flat pulley.

Classical V-Belts for JIS (M,A,B,C,D) are suitable for the drive.

The following prerequisites must be fulfilled to ensure the operating reliability of V-Belt drive:

- The small pulley must be a grooved pulley.
- Speed ratio must be $SR \geq 3$.
- Belt speed must be $V \leq 25$ m/sec.
- The pitch diameter of flat pulley = Outside diameter + Value of table 3-11
- Relation between pulley diameter and Center distance must be fulfilled the following formula.

$$0.48 \leq \frac{D_p - d_p}{C} \leq 1.17$$

D_p : Pitch diameter of flat pulley (mm)

d_p : Pitch diameter of V pulley (mm)

C : Center distance (mm)

Table 3-10
Arc of contact correction factor for V-Belt drives

$\frac{D_p - d_p}{C}$	Contact of small pulley $\theta (^{\circ})$	Correction factor K_{θ}
0.00	180	0.75
0.10	174	0.76
0.20	169	0.78
0.30	163	0.79
0.40	157	0.80
0.50	151	0.81
0.60	145	0.83
0.70	139	0.84
0.80	133	0.85
0.90	127	0.85
1.00	120	0.82
1.10	113	0.80
1.20	106	0.77
1.30	99	0.73
1.40	91	0.70
1.50	83	0.65

Table 3-11
Difference between pulley pitch diameter and outside diameter

Belt Section	M	A	B	C	D	E
Difference between pitch diameter and outside diameter (mm)	5.4	9.0	11.0	14.0	19.0	25.4



Multi V-Belts

⚠ MITSUBOSHI MULTI (Banded) V-Belt is made up of two or more standard V-Belts connected together at the top as shown in the picture. No special pulleys are needed, as the individual belts have the same cross section and spacing as those which operate on standard pulleys. The top backing of Multi V-Belts does not come in contact with the top of the pulleys, so each multiple belt produces the same wedge effect as a single belt.



Fig. 3-7

Advantage of Multi (Banded) V-Belts

In most of the applications, V-Belts can meet the drive requirements. However, under certain operating conditions, belt whipping or vibration may become a critical problem, causing belts ultimately to come off the drive possible causes include the following:

- 1) Load vibration occurs periodically either on the driver side or at the drive unit, e.g. internal combustion engine, air compressor or piston pump.
- 2) There is excessively large load vibration or shock load, e.g. hoist or press.
- 3) Long span.
- 4) Vertical shaft length drives.

Belt vibration occurs laterally, as well as vertically. Under these conditions single matched sets of belts will be out of alignment in entering the pulley and will be damaged turned over or thrown off the drive. Multi V-Belts are recommended for use under these conditions as they can stand lateral stress, and belt vibration is virtually eliminated, resulting in longer belt life expectancy.

How to select Multi V-Belts

1) Size range

The available sizes are as follows.

Available range of Multi V-Belts Table 3-12

Cross section	Range of available size	Center to center of pulley grooves(P)
B, BX	B60~B315	19mm
C, CX	C76~C720	25.4mm
D	D90~D600	36.5mm
3V, 3VX	3V600~3V1400	10.3mm
5V, 5VX	5V630~5V3550	17.5mm
8V	8V1000~8V5000	28.6mm
SPB	SPB2120~SPB10287	19.0mm
SPC	SPC2120~SPC10668	25.5mm

Fig. 3-8

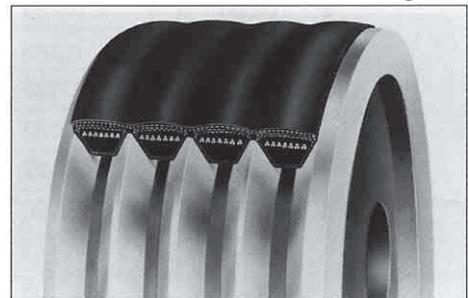

2) Number of ribs

Multi V-Belts are available in 2,3,4 and 5 ribs.

They may be used in matched sets for drives requiring more than 5 belts, as shown in the following table.

Table 3-13

Number of belts	Recommended combination	Number of belts	Recommended combination	Number of belts	Recommended combination
2	2	9	5,4	16	4,4,4,4
3	3	10	5,5	17	4,4,5,4
4	4	11	4,3,4	18	4,4,5,5
5	5	12	4,4,4	19	5,4,5,5
6	3,3	13	4,5,4	20	5,5,5,5
7	3,4	14	5,4,5		
8	4,4	15	5,5,5		



Tensioning of Multi V-Belts

The usual tensioning method by Deflection load may not be usable for the accurate checking of tensioning of Multi V-Belts.

Initial tension can be alternatively checked by the elongation method as follows:

Step1

Find minimum static tension per a belt (T_o), using formula on page 2-20.

Then find the range of recommendation tension.

Minimum tension= T_o

Maximum tension $T_{max.} = 1.5 \times T_o$.

Step2

Find the amount of elongation for belt to obtain the above tensions.

- Measurement Outer length of the belt at no tension. This can be done with the belt either on or off the drive.

- Find the belt length multipliers from below table for the above tension.

- Multiply the measured Outer length of the belt by each belt length multiplier to obtain elongated outside circumference corresponding to each calculated tension.

Step3

Tense the drive until the measured outside circumference falls within the range of elongated minimum and maximum length values determined above.

Belt length multiplier for Classical V-Belts for JIS

Table 3-14

Calculated Tension T_o (N)	Cross section			Calculated Tension T_o (N)	Cross section		
	B	C	D		B	C	D
196	1.0026			883		1.009	1.0045
294	1.0039	1.003		981		1.010	1.0050
392	1.0053	1.004		1180			1.0060
490	1.0067	1.005		1370			1.0070
588	1.0080	1.006	1.0030	1570			1.0080
686	1.0093	1.007	1.0035	1770			1.0090
785	1.0107	1.008	1.0040	1960			1.0100

Belt length multiplier for Maxstar Wedge V-Belts for RMA / MPTA

Table 3-15

Calculated Tension T_o (N)	Cross section			Calculated Tension T_o (N)	Cross section		
	3V	5V	8V		3V	5V	8V
177	1.00228			981		1.00648	1.00220
196	1.00265			1180		1.00819	1.00275
216	1.00303			1370		1.01003	1.00334
245	1.00361			1570		1.01201	1.00397
265	1.00400			1770		1.01412	1.00463
294	1.00459			1960		1.01637	1.00532
314	1.00500			2210		1.01937	1.00625
343	1.00561			2450			1.00723
363	1.00603			2700			1.00826
392	1.00667			2940			1.00936
412	1.00710			3190			1.01051
441	1.00775	1.00228		3430			1.01172
461	1.00819	1.00261		3680			1.01299
490	1.00887	1.00281		3920			1.01431
588	1.01120	1.00347		4170			1.01569
686	1.01365	1.00417		4410			1.01713
785	1.01624	1.00491		4900			1.01863
883	1.01896	1.00568					



Storage and Handling of V-Belts

Storage of V-Belts

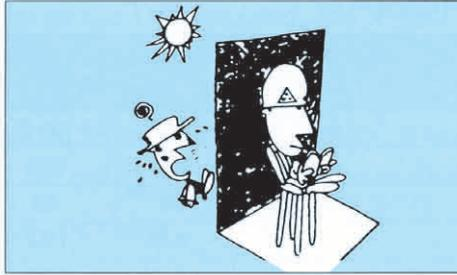

Do not expose belts direct to sunlight during storage. Store belts in shelves or hang belts on racks. Avoid placing belts on floor or ground. Avoid piling belts up. Avoid storing belts in heavily bent condition.

Keep belts away from oil and grease.

Installation of V-Belts

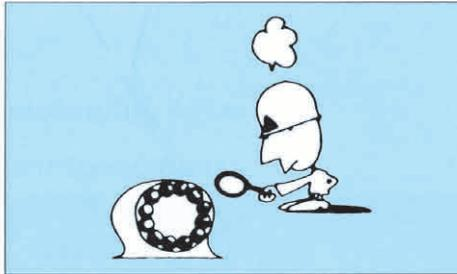

Check bearing for oil.

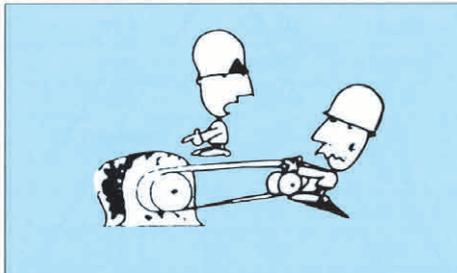

Slack off on take-up until belts can be placed in grooves without forcing. Never pry the belts into the pulley grooves to prevent cord break.

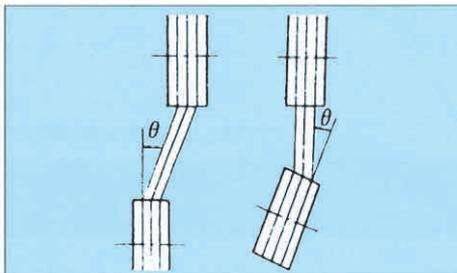

Check pulley alignment. Misalignment of pulley will shorten the belt life. Keep deflection angle less than $1/3^\circ$.

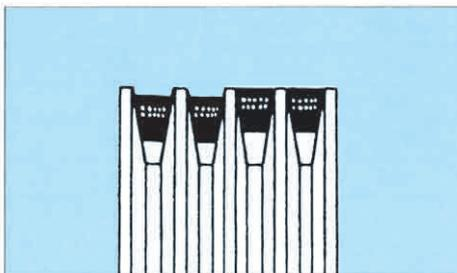

Make sure all pulley grooves are equal in dimensions.

Uneven pulley grooves wear produces the same bad effect as mismatched belts.



Tension drive properly. See page 3-5~3-7 for belt tensioning method. Give belts a few day running time to become seated in pulley grooves, then readjust take-up if necessary

Maintenance

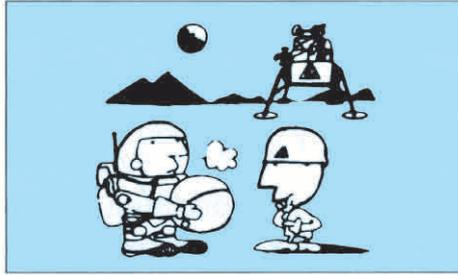

Make sure V-Belt drives are covered for safety before turning the machine on. An air tight cover shortens the belt life because it prevent heat radiation. Maintain proper ventilation.

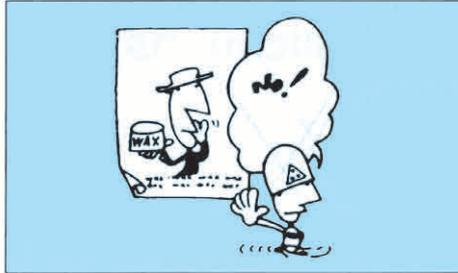

Never use a belt dressing. Be careful not to expose belts to water, oil or chemicals.

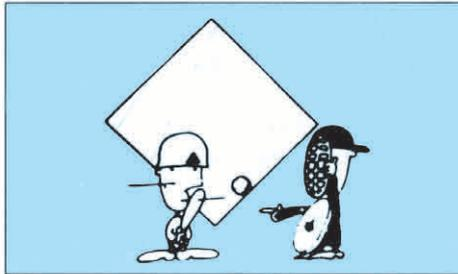

Always use a set of new belts from one manufacture to replace a set of belts. Mixing new and used belts in a set will shorten the belt life due to unequal stretch of belts.

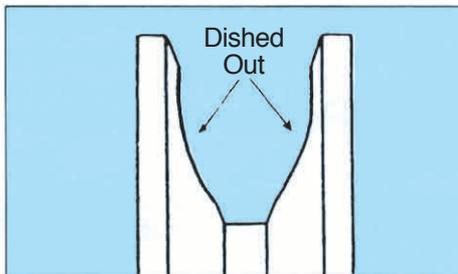

Check pulley for groove wear. If more than 1/32 inch (0.794mm) of "Dished Out" can be seen, short belt life may be expected.



Request for belt design

Date: _____

Customer's Name							
OEM/Replacement							
Purpose							
Model Name							
Drawing	available	not available	availability: yes / no (Date: _____)				
Specification of Belt							
Belt Size							
Number of Belts	pcs.						
Annual Quantity	pcs./year						
Operating Conditions	Type of Prime Mover	Power		kW		N•m	maximum torque
	Speed	Drive		rpm	Driven		rpm
	Pulley datum diameter	Drive		mm/teeth	Driven		mm/teeth
	Center distance		±		mm	Speed ratio	
	Operational Hours per day		hrs./day		Idler Pulley:		
	Other Special Conditions						
	Ambient Conditions						

Other Information

Information for designing	
Information for price	



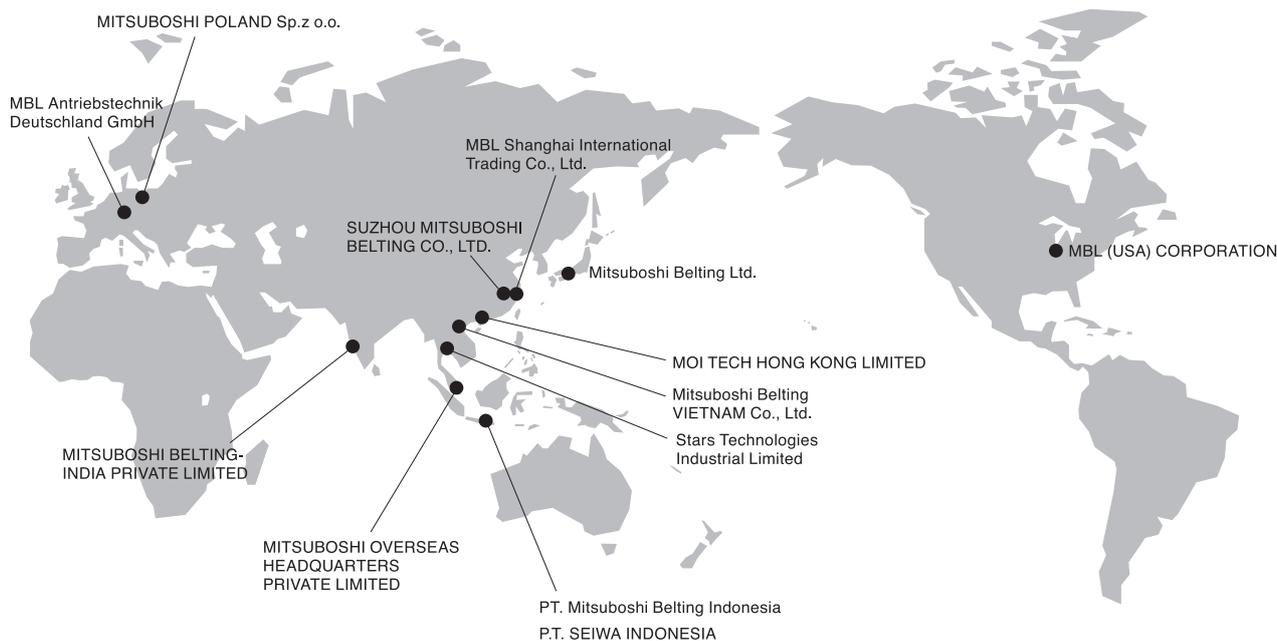

JAPAN

●Mitsuboshi Belting Ltd.

(Kobe Head Office)
4-1-21 Hamazoe-dori, Nagata-ku,
Kobe 653-0024, Japan
Tel: +81-78-671-5071 Fax: +81-78-685-5670

(Tokyo Head Office)
2-3-4 Nihonbashi Chuo-ku,
Tokyo 103-0027, Japan
Tel: +81-3-5202-2500 Fax: +81-3-5202-2520

ASIA

●MITSUBOSHI OVERSEAS HEADQUARTERS PRIVATE LIMITED

14 Jurong Port Road, Singapore 619091
Tel:+65-6265-3933 Fax:+65-6265-0954
E-mail:sales@mitsuboshi.com.sg

●Stars Technologies Industrial Limited

Eastern Seaboard Industrial Estate 64/40 Moo 4,
Tambon Pluakdaeng, Amphur Pluakdaeng,
Rayong 21140 Thailand
TEL:+66-38-954-738 FAX:+66-38-954-740

●P.T. SEIWA INDONESIA

Jl. Lombok I, Blok M-2-2, Kawasan Berikat,
MM2100 Industrial Town, Cikarang Barat,
Bekasi 17520, INDONESIA
Tel:+62-21-898-0324 Fax:+62-21-898-0325

●PT. Mitsuboshi Belting Indonesia

Km.8 Raya Serang, Jl. Industri Raya Blok D No.4,
Jatiuwung, Tangerang 15135, Indonesia
Tel:+62-21-590-2070 Fax:+62-21-590-2071

●MBL Shanghai International Trading Co., Ltd.

F8, NO.601 Tianshan Road, Shanghai, China
Tel:+86-21-5206-7008 Fax:+86-21-5206-7011

●SUZHOU MITSUBOSHI BELTING CO., LTD.

277 Liangang Road Suzhou New District Jiangsu 215129, China
Tel:+86-512-6665-8880 Fax:+86-512-6665-8886

●MOI TECH HONG KONG LIMITED

Unit2, 21/F, CCT Telecom Building, No.11 Wo Shing Street,
Shatin, New Territories, Hong Kong
Tel:+852-2403-5978 Fax:+852-2422-8308

●MITSUBOSHI BELTING-INDIA PRIVATE LIMITED

W-191F, TTC Industrial Area, MIDC, Thane-Belapur Road,
Navi Mumbai 400710, Maharashtra, India
Tel: +91-22-27788431 Fax: +91-22-27788439
E-mail:customercare@mitsuboshi.co.in

●Mitsuboshi Belting VIETNAM Co., Ltd.

Room No.1511, 15th Floor, ICON4 Tower,
No.243A De La Thanh St, Dong Da Dist,
Hanoi, VIETNAM
Tel: +84-4-3760-6625 Fax: +84-4-6266-2608

AMERICA

●MBL (USA) CORPORATION

601 Dayton Road Ottawa Illinois 61350-9535 USA
Tel: +1-815-434-1282 Fax: +1-815-434-2897
E-mail: sales@mblusa.com
URL: http://www.mblusa.com

EUROPE

●MBL Antriebstechnik Deutschland GmbH

Hansemannstrasse 63, 41468 Neuss Germany
Tel:+49- 2131-740940 Fax:+49- 2131-7409424
E-mail: info@mitsuboshi.de
URL: www.mitsuboshi.de

●MITSUBOSHI POLAND Sp.z o.o.

Budynek B8 ul. 3-go Maja 8, 05-800 Pruszkow, Poland
Tel:+48-22-7383930 Fax:+48-22-7383939



MITSUBOSHI BELTING LTD.

The information contained in this catalogue is for an informational purpose only.

IN NO EVENT SHALL MITSUBOSHI BE LIABLE FOR ANY INDIRECT, SPECIAL, PUNITIVE, INCIDENTAL OR CONSEQUENTIAL DAMAGES OR LOST PROFITS, ARISING OUT OF OR RELATED TO MITSUBOSHI PRODUCTS NOR FOR ANY DAMAGES ARISING DUE TO ANY USE OF MITSUBOSHI PRODUCTS NOT IN CONFORMANCE WITH THE INSTRUCTION PROVIDED BY MITSUBOSHI IN THIS CATALOGUE. MITSUBOSHI SPECIFICALLY DISCLAIMS ANY IMPLIED WARRANTY OF MERCHANTABILITY OR FITNESS FOR PARTICULAR PURPOSE.